

PRODUCT FEATURES

- Isolated Module Package
- Isolation Voltage 3000 V
- Three Phase Bridge and a Thyristor

APPLICATIONS

- Current Stabilized Power Supply
- Switching Power Supply
- Inverter For AC or DC Motor Control

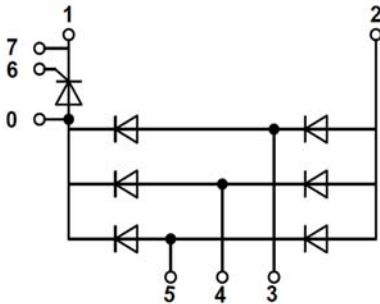

Thyristor -ABSOLUTE MAXIMUM RATING ($T_c=25^\circ\text{C}$ unless otherwise specified)

Symbol	Parameter/Test Conditions		Values	Unit
V_{RRM}	Repetitive Peak Reverse Voltage		1600	V
V_{DRM}	Repetitive Peak Off-State Voltage		1600	
V_{RSM}	Non-Repetitive Peak Reverse Voltage		1700	
$I_{T(AV)}$	Average On State Current	Single phase, half wave, 180° conduction, $T_c=85^\circ\text{C}$	100	A
$I_{T(RMS)}$	R.M.S. On State Current		157	
I_{TSM}	Non-Repetitive Surge On-State Current	1/2 cycle, 50/60HZ, peak value, $T_J=45^\circ\text{C}$	2000/2200	
I^2t	For Fusing	1/2 cycle, 50/60HZ, peak value, $T_J=45^\circ\text{C}$	20/20.1	KA^2S
T_J	Junction Temperature(Thyristor)		-40 to +125	$^\circ\text{C}$

Three Phase Bridge -ABSOLUTE MAXIMUM RATINGS ($T_c=25^\circ\text{C}$ unless otherwise specified)

Symbol	Parameter/Test Conditions		Values	Unit
V_{RRM}	Repetitive Peak Reverse Voltage		1600	V
V_{RSM}	Non-Repetitive Peak Reverse Voltage		1700	
I_D	Output Current(D.C.)	Three phase, half wave, $T_c=100^\circ\text{C}$	100	A
I_{FSM}	Non-Repetitive Surge Forward Current	1/2 cycle, 50/60HZ, peak value, $T_J=45^\circ\text{C}$	1260/1380	
I^2t	For Fusing	1/2 cycle, 50/60HZ, peak value, $T_J=45^\circ\text{C}$	7.9/7.9	KA^2S
T_J	Junction Temperature(Diode)		-40 to +150	$^\circ\text{C}$

MacMic Science & Technology Co., Ltd.

Add: #18, Hua Shan Zhong Lu, New District, Changzhou City, Jiangsu Province, P. R. of China

Tel.: +86-519-85163708 Fax: +86-519-85162291 Post Code: 213022 Website: www.macmicst.com

MMK100U160UX

Thyristor -ELECTRICAL CHARACTERISTICS ($T_C=25^\circ\text{C}$ unless otherwise specified)

Symbol	Parameter/Test Conditions		Min.	Typ.	Max.	Unit
I_{DRM}	Maximum Peak Off-State Current	$V_D = V_{DRM}, T_J = 125^\circ\text{C}$			25	mA
I_{RRM}	Maximum Peak Reverse Current	$V_R = V_{RRM}, T_J = 125^\circ\text{C}$			25	
V_{TM}	Maximum on-state voltage drop	$I_{TM}=315\text{A}, t_d=10\text{ ms, half sine}$			1.65	V
V_{TO}	For power-loss calculations only	$T_J = 125^\circ\text{C}$			0.88	V
r_T						2.7
V_{GT}	Max. required DC gate voltage to trigger	$V_A=6\text{V}, R_A=1\Omega, T_J = -40^\circ\text{C}$			4.0	V
		$V_A=6\text{V}, R_A=1\Omega$		1.0	2.5	
		$V_A=6\text{V}, R_A=1\Omega, T_J = 125^\circ\text{C}$			1.7	
I_{GT}	Max. required DC gate current to trigger	$V_A=6\text{V}, R_A=1\Omega, T_J = -40^\circ\text{C}$			270	mA
		$V_A=6\text{V}, R_A=1\Omega$		75	150	
		$V_A=6\text{V}, R_A=1\Omega, T_J = 125^\circ\text{C}$			80	
V_{GD}	Max. required DC gate voltage not to trigger,	$V_D = V_{DRM}, T_J = 125^\circ\text{C}$			0.25	V
I_{GD}	Max. required DC gate current not to trigger,	$V_D = V_{DRM}, T_J = 125^\circ\text{C}$			6	mA
I_H	Maximum holding current			150	300	mA
I_L	Maximum latching current			200	400	mA
P_{GM}	Maximum peak gate power				12	W
$P_{G(AV)}$	Maximum average gate power				3.0	
I_{GM}	Maximum peak gate current				3.0	A
$-V_{GM}$	Maximum peak negative gate voltage				10	V
dv/dt	Critical Rate of Rise of Off-State Voltage, $T_J=125^\circ\text{C}$, exponential to 67% rated V_{DRM}				1000	V/ μs
di/dt	$V_D = 2/3V_{DRM}, I_G = 0.3\text{A}$, dig/dt=0.3A/ μs , $T_J = 125^\circ\text{C}$				150	A/ μs
$R_{th(J-C)}$	Junction-to-Case Thermal Resistance(Thyristor)				0.24	K/W

Three Phase Bridge -ELECTRICAL CHARACTERISTICS ($T_C=25^\circ\text{C}$ unless otherwise specified)

Symbol	Parameter/Test Conditions		Min.	Typ.	Max.	Unit
I_{RM}	Maximum Reverse Leakage Current	$V_R = V_{RRM}$			0.5	mA
		$V_R = V_{RRM}, T_J = 125^\circ\text{C}$			10	
V_F	Forward Voltage Drop	$I_F=100\text{A}$			1.35	V
V_{TO}	For power-loss calculations only , $T_J = 125^\circ\text{C}$				0.9	V
r_T						4.5
$R_{th(J-C)}$	Junction-to-Case Thermal Resistance	per diode			0.84	K/W
		per module			0.14	

MODULE CHARACTERISTICS ($T_C=25^\circ\text{C}$ unless otherwise specified)

T_{JOP}	Operating Temperature		-40 to +125	$^\circ\text{C}$
T_{STG}	Storage Temperature Range		-40 to +125	$^\circ\text{C}$
V_{ISO}	Isolation Breakdown Voltage	AC, 50Hz(R.M.S), t=1minute	3000	V
Torque	to heatsink	Recommended (M6)	3~5	Nm
	to terminal	Recommended (M5)	2.5~5	Nm
Weight			215	g

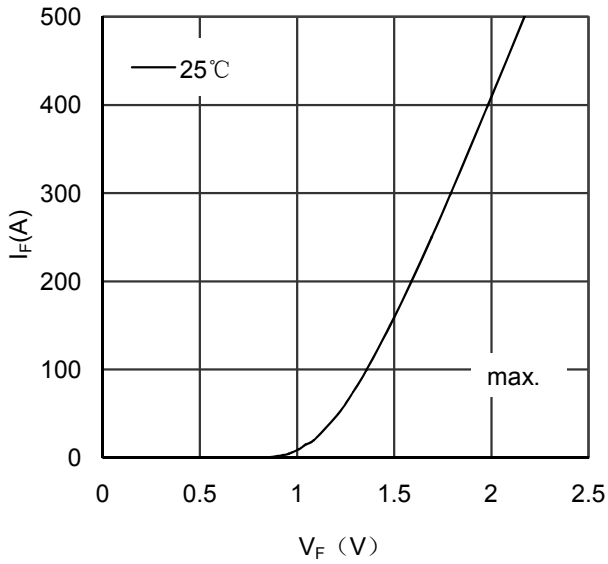

Figure 1. Diode Forward Voltage Drop vs Forward Current

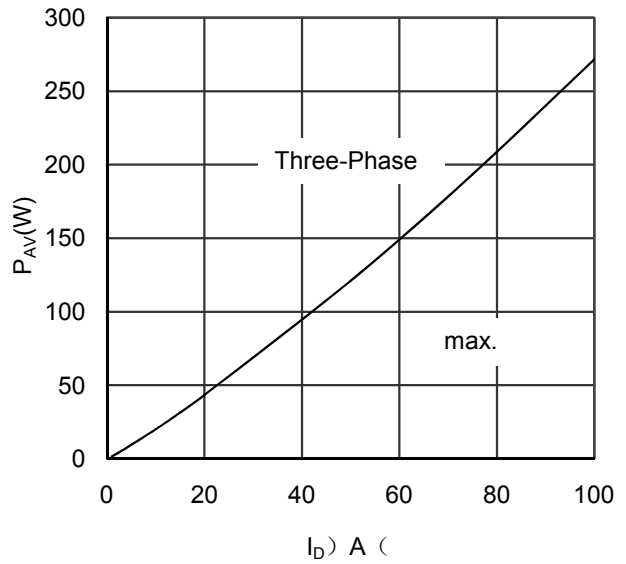

Figure 2. Diode Power dissipation vs Output Current

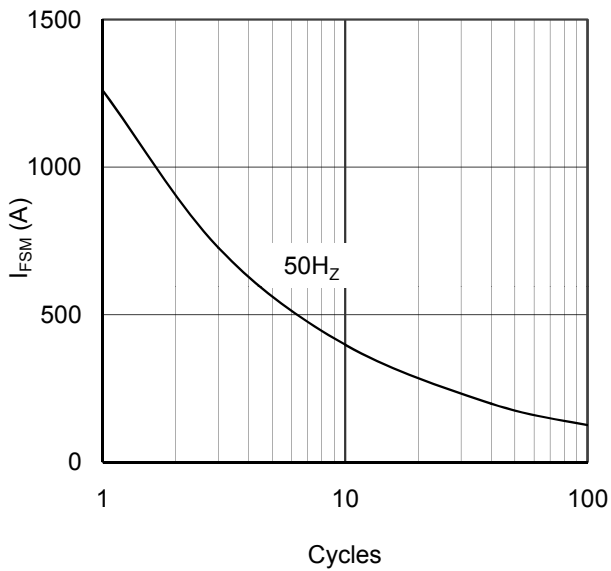

Figure 3. Diode Max Non-Repetitive Forward Surge Current

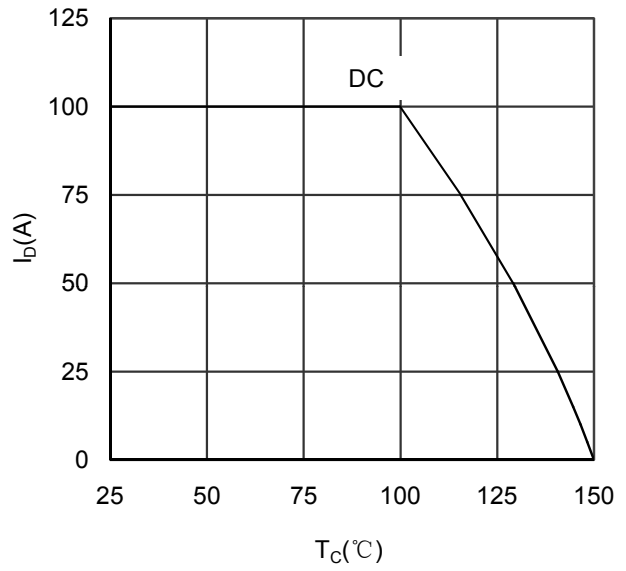

Figure 4. Diode Output current vs Case temperature

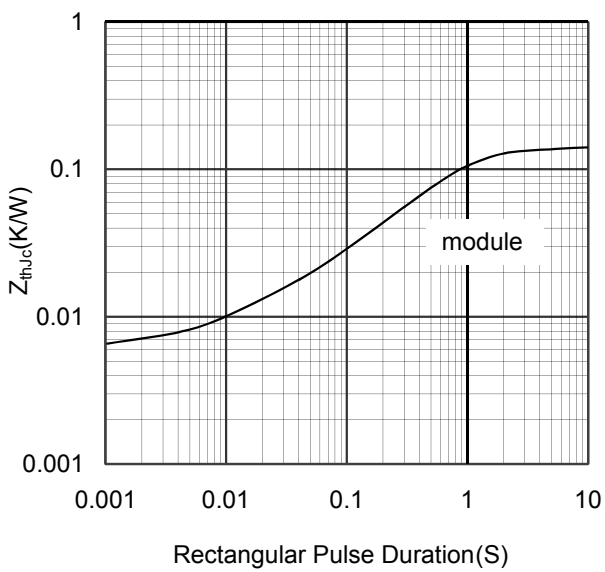

Figure 5. Transient Thermal Impedance-Diode

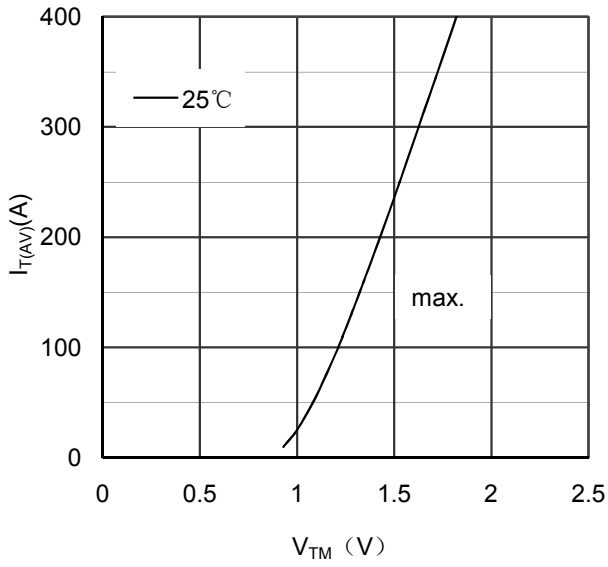

Figure 6. SCR Average On State Current vs Forward Voltage

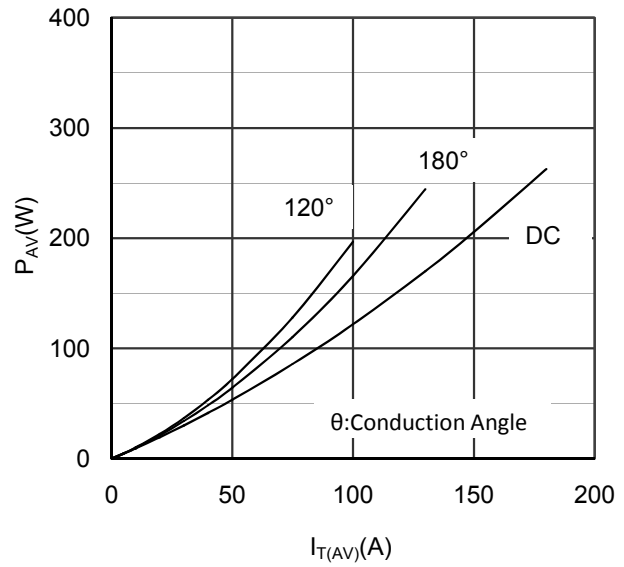

Figure 7. SCR Power dissipation vs $I_{T(AV)}$

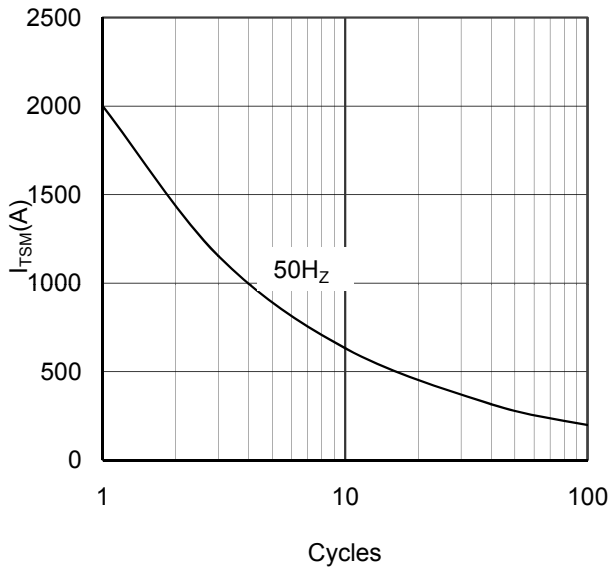

Figure 8. SCR Max Non Repetitive Surge On State Current

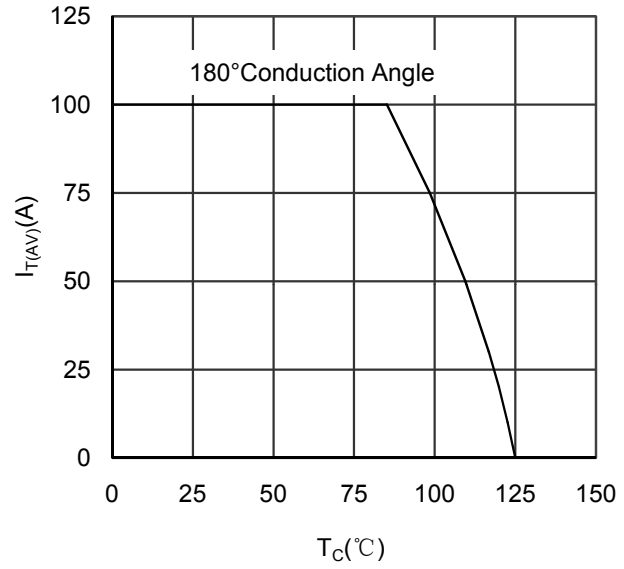

Figure 9. SCR On State current vs Case temperature

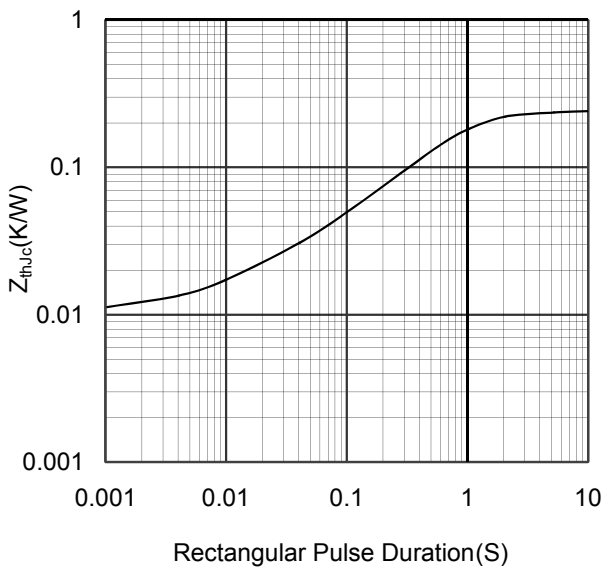

Figure 10. Transient Thermal Impedance-Thyristor

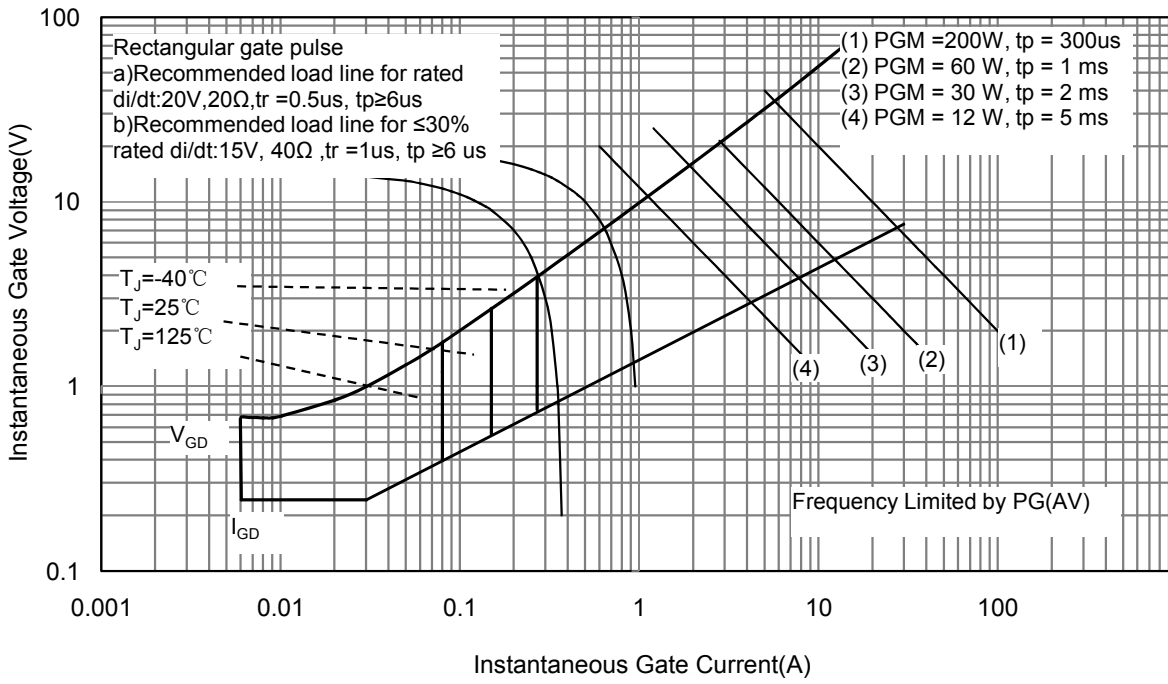
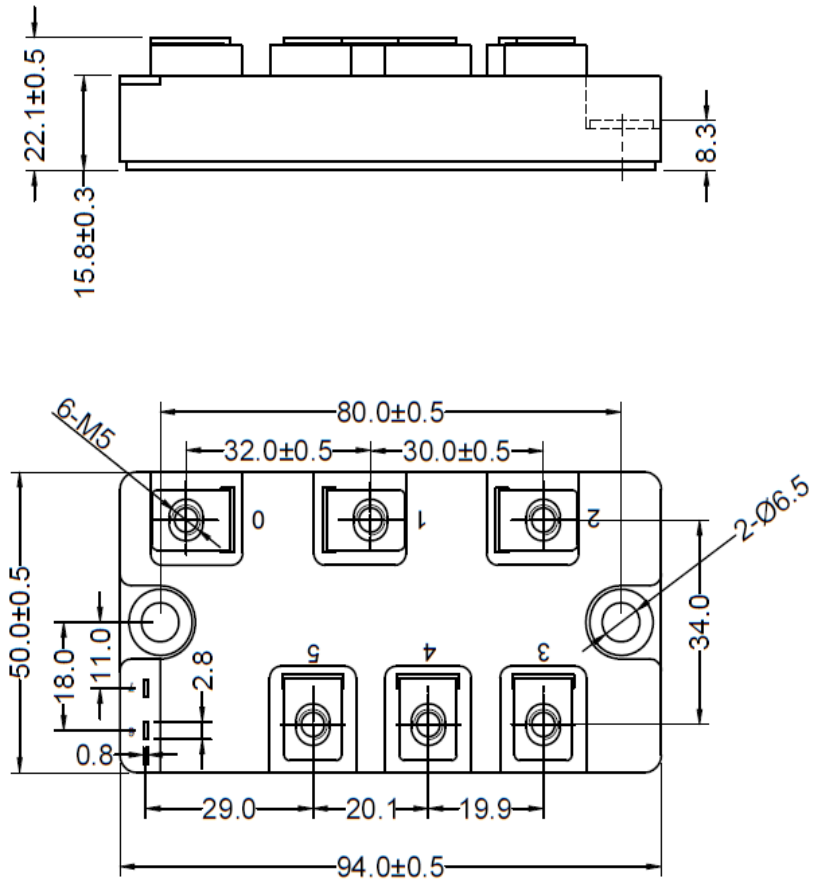

Figure 11. SCR Gate Characteristics



Dimensions in (mm)
 Figure 12. Package Outline