

PRODUCT FEATURES

- Ultrafast Reverse Recovery Time
- Soft Reverse Recovery Characteristics
- Low Reverse Recovery Loss
- High System Power Density
- Popular SOT-227 Package



APPLICATIONS

- Inversion Welder
- Uninterruptible Power Supply
- Plating Power Supply
- Ultrasonic Cleaner and Welder
- Converter & Chopper
- PFC

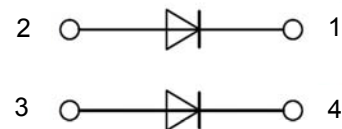

ABSOLUTE MAXIMUM RATINGS($T_C=25^{\circ}\text{C}$ unless otherwise specified)

| Symbol | Parameter/Test Conditions | | Values | Unit |
|--------------|---|--|-------------|-----------------------------|
| V_R | Maximum D.C. Reverse Voltage | | 700 | V |
| V_{RRM} | Maximum Repetitive Reverse Voltage | | | |
| $I_{F(AV)}$ | Average Forward Current | $T_C=90^{\circ}\text{C}$, Per Diode | 60 | A |
| | | $T_C=90^{\circ}\text{C}$, Per Moudle | 120 | |
| $I_{F(RMS)}$ | RMS Forward Current | $T_C=90^{\circ}\text{C}$, Per Diode | 84 | |
| I_{FSM} | Non Repetitive Surge Forward Current | $T_J=45^{\circ}\text{C}$, t=10ms, Sine, peak value | 600 | |
| | | $T_J=45^{\circ}\text{C}$, t=8.3ms, Sine, peak value | 660 | |
| I^2t | For Fusing | $T_J=45^{\circ}\text{C}$, t=10ms, Sine, peak value | 1800 | A^2S |
| | | $T_J=45^{\circ}\text{C}$, t=8.3ms, Sine, peak value | 1807 | |
| P_D | Power Dissipation | | 208 | W |
| T_J | Junction Temperature | | -40 to +150 | $^{\circ}\text{C}$ |
| T_{STG} | Storage Temperature Range | | -40 to +125 | $^{\circ}\text{C}$ |
| V_{isol} | Isolation Breakdown Voltage | AC, 50Hz(R.M.S), t=1minute | 3000 | V |
| Torque | Module to Sink | Recommended (M4) | 0.7~1.1 | Nm |
| Torque | Module Electrodes | Recommended (M4) | 0.7~1.1 | Nm |
| R_{thJC} | Junction to Case Thermal Resistance(Per Diode) | | 0.6 | $^{\circ}\text{C}/\text{W}$ |
| Weight | | | 26.5 | g |

MacMic Science & Technology Co., Ltd.

Add: #18, Hua Shan Zhong Lu, New District, Changzhou City, Jiangsu Province, P. R. of China

Tel.: +86-519-85163708 Fax: +86-519-85162291 Post Code: 213022 Website: www.macmicst.com

MMF2X60J070D

ELECTRICAL CHARACTERISTICS ($T_C=25^\circ\text{C}$ unless otherwise specified)

| Symbol | Parameter/Test Conditions | Min. | Typ. | Max. | Unit |
|-----------|---|--|------|------|------|
| I_{RM} | Maximum Reverse Leakage Current | $V_R = 700\text{V}$ | | 0.5 | mA |
| | | $V_R = 700\text{V}, T_J = 125^\circ\text{C}$ | | 10 | |
| V_F | Forward Voltage | $I_F=60\text{A}$ | 1.15 | 1.5 | V |
| | | $I_F=60\text{A}, T_J=125^\circ\text{C}$ | 1.0 | | |
| t_{rr} | Reverse Recovery Time ($I_F = 1\text{A}, dI_F/dt = -200\text{A}/\mu\text{s}, V_R = 30\text{V}$) | | 50 | | ns |
| t_{rr} | Reverse Recovery Time | | 150 | | ns |
| I_{RRM} | Maximum Reverse Recovery Current | | 18 | | A |
| t_{rr} | Reverse Recovery Time | | 260 | | ns |
| I_{RRM} | Maximum Reverse Recovery Current | | 28 | | A |

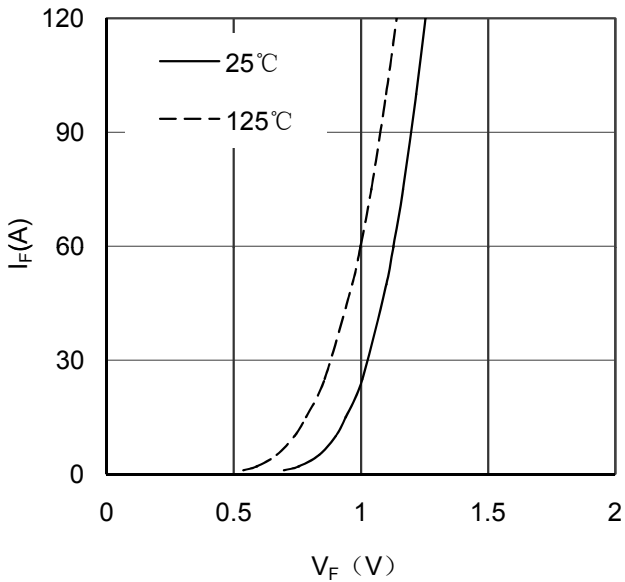

Figure 1. Forward Voltage Drop vs Forward Current

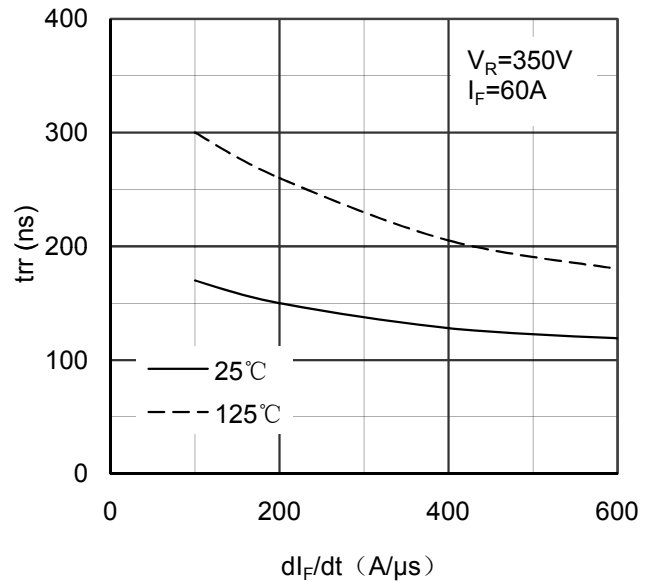

Figure 2. Reverse Recovery Time vs dI_F/dt

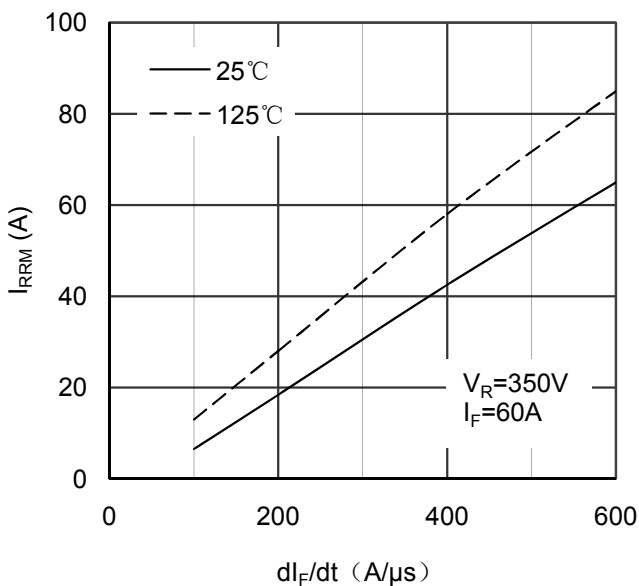

Figure 3. Reverse Recovery Current vs dI_F/dt

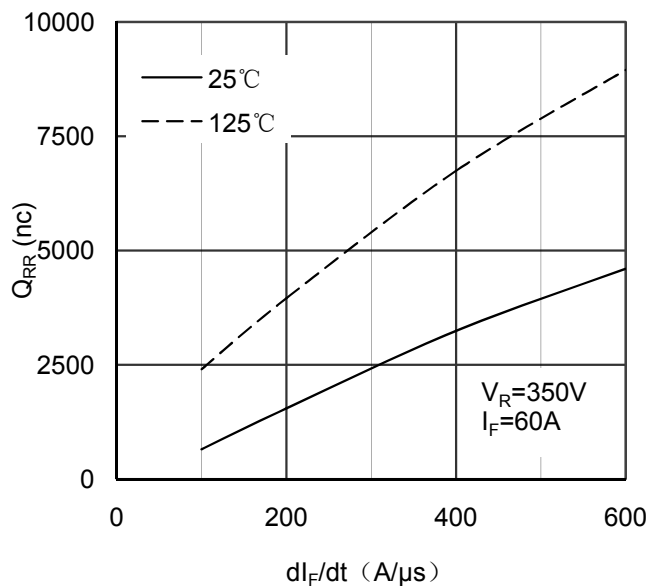

Figure 4. Reverse Recovery Charge vs dI_F/dt

MMF2X60J070D

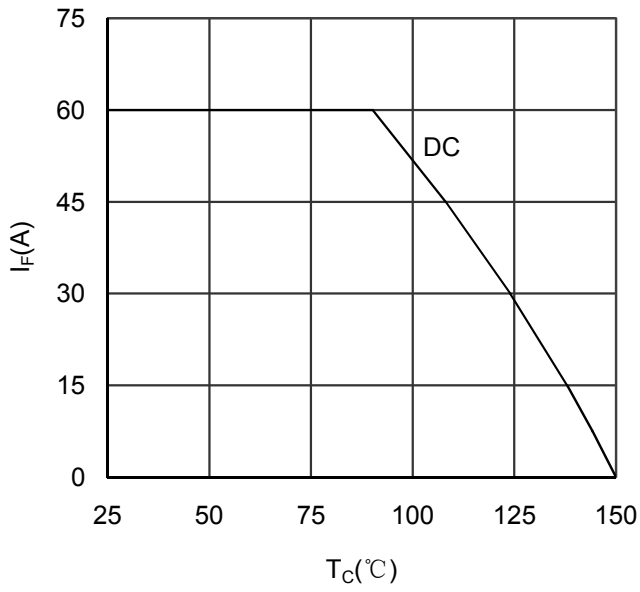

Figure 5. Forward current vs Case temperature

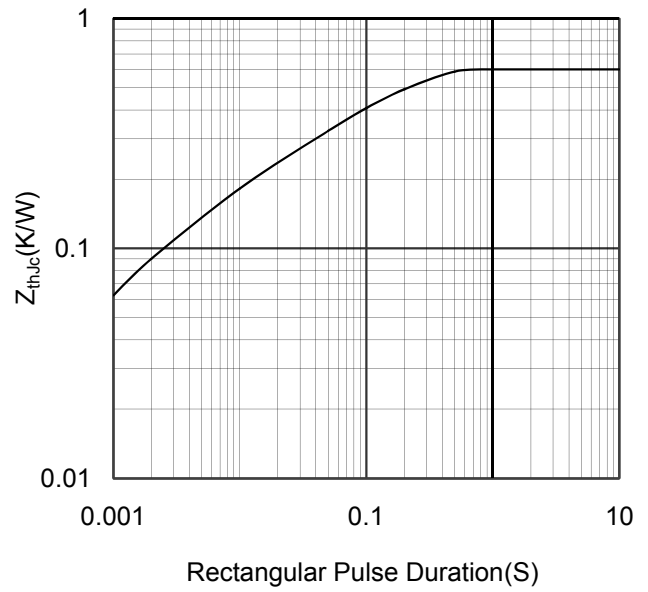
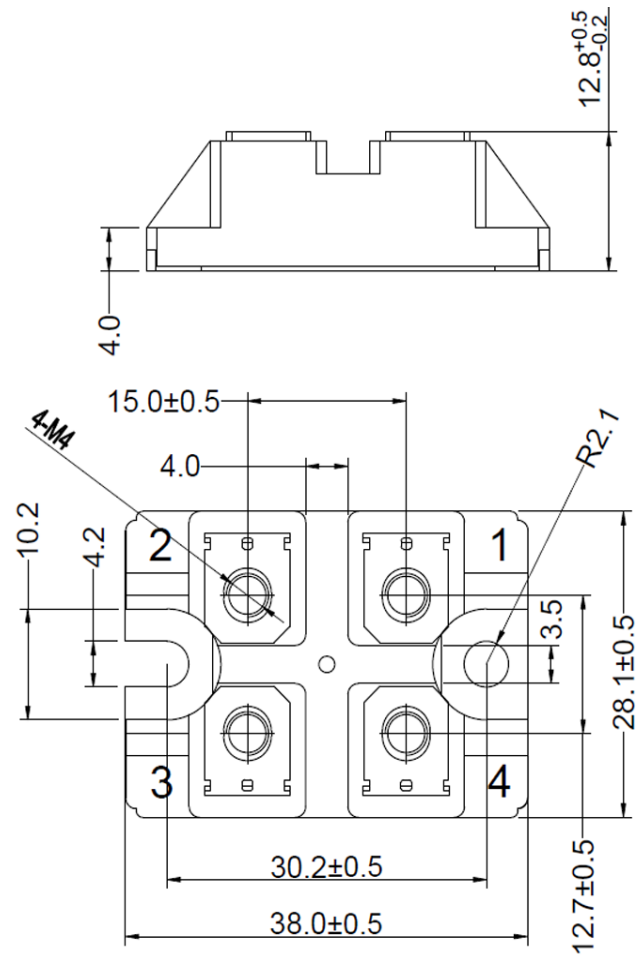

Figure 6. Transient Thermal Impedance



Dimensions in (mm)
Figure 7. Package Outline