

PRODUCT FEATURES

- Ultrafast Reverse Recovery Time
- Soft Reverse Recovery Characteristics
- Low Reverse Recovery Loss
- Low Forward Voltage
- High Surge Current Capability
- Low Leakage Current



APPLICATIONS

- Inversion Welder
- Uninterruptible Power Supply
- Plating Power Supply
- Ultrasonic Cleaner and Welder
- Converter & Chopper
- PFC

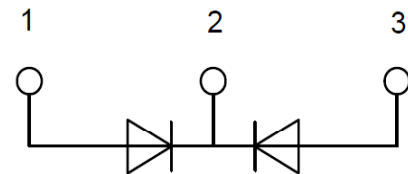

ABSOLUTE MAXIMUM RATINGS ($T_C = -25^\circ\text{C}$ unless otherwise specified)

Symbol	Parameter/Test Conditions		Values	Unit
V_R	Maximum D.C. Reverse Voltage		200	V
V_{RRM}	Maximum Repetitive Reverse Voltage			
$I_{F(AV)}$	Average Forward Current	$T_C = 80^\circ\text{C}$, Per Diode	200	A
		$T_C = 80^\circ\text{C}$, Per Module	400	
$I_{F(RMS)}$	RMS Forward Current	$T_C = 80^\circ\text{C}$, Per Diode	282	
I_{FSM}	Non Repetitive Surge Forward Current	$T_J = 45^\circ\text{C}$, $t = 10\text{ms}$, Sine, peak value	2000	
		$T_J = 45^\circ\text{C}$, $t = 8.3\text{ms}$, Sine, peak value	2200	
I^2t	For Fusing	$T_J = 45^\circ\text{C}$, $t = 10\text{ms}$, Sine, peak value	20000	A^2S
		$T_J = 45^\circ\text{C}$, $t = 8.3\text{ms}$, Sine, peak value	20086	
P_D	Power Dissipation		370	W
T_J	Junction Temperature		-40 to +150	$^\circ\text{C}$
T_{STG}	Storage Temperature Range		-40 to +125	$^\circ\text{C}$
V_{isol}	Isolation Breakdown Voltage	AC, 50Hz(R.M.S), $t = 1\text{minute}$	3000	V
Torque	Module to Sink	Recommended (M5)	2.5~4	Nm
Torque	Module Electrodes	Recommended (M5)	2.5~4	Nm
R_{thJC}	Junction to Case Thermal Resistance(Per Diode)		0.34	$^\circ\text{C}/\text{W}$
Weight			100	g

MacMic Science & Technology Co., Ltd.

Add: #18, Hua Shan Zhong Lu, New District, Changzhou City, Jiangsu Province, P. R. of China

MMF400N020DK2B

ELECTRICAL CHARACTERISTICS ($T_C=25^\circ\text{C}$ unless otherwise specified)

Symbol	Parameter/Test Conditions	Min.	Typ.	Max.	Unit
I_{RM}	Maximum Reverse Leakage Current	$V_R = 200\text{V}$		1	mA
		$V_R = 200\text{V}, T_J = 125^\circ\text{C}$		10	
V_F	Forward Voltage	$I_F=200\text{A}$	0.9	1.15	V
		$I_F=200\text{A}, T_J=125^\circ\text{C}$		0.8	
t_{rr}	Reverse Recovery Time ($I_F = 1\text{A}, di_F/dt = -200\text{A}/\mu\text{s}, V_R = 30\text{V}$)		42		ns
t_{rr}	Reverse Recovery Time		135		ns
I_{RRM}	Maximum Reverse Recovery Current		15.5		A
t_{rr}	Reverse Recovery Time		195		ns
I_{RRM}	Maximum Reverse Recovery Current		23		A

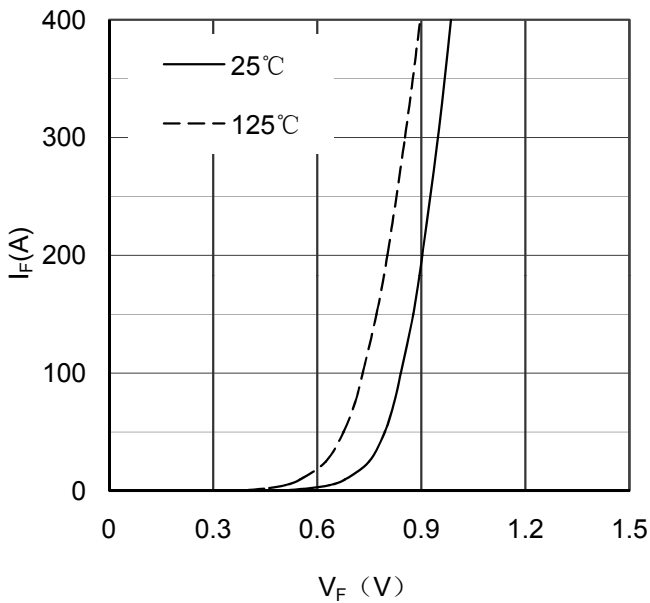

Figure 1. Forward Voltage Drop vs Forward Current

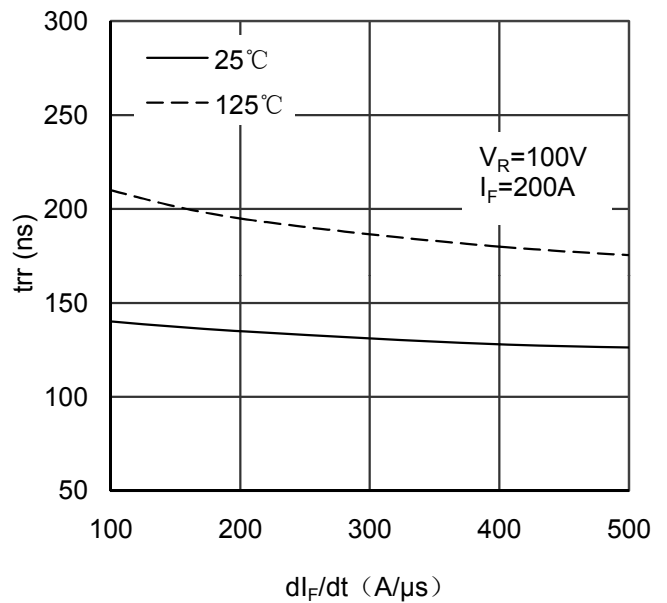

Figure 2. Reverse Recovery Time vs di_F/dt

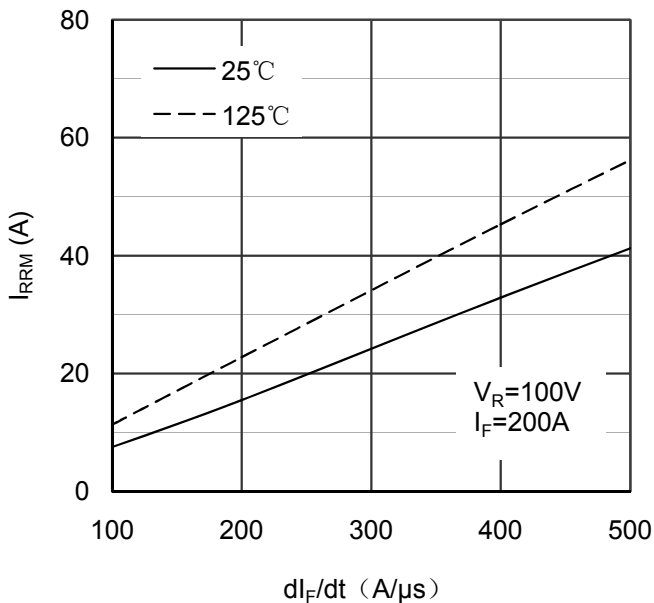

Figure 3. Reverse Recovery Current vs di_F/dt

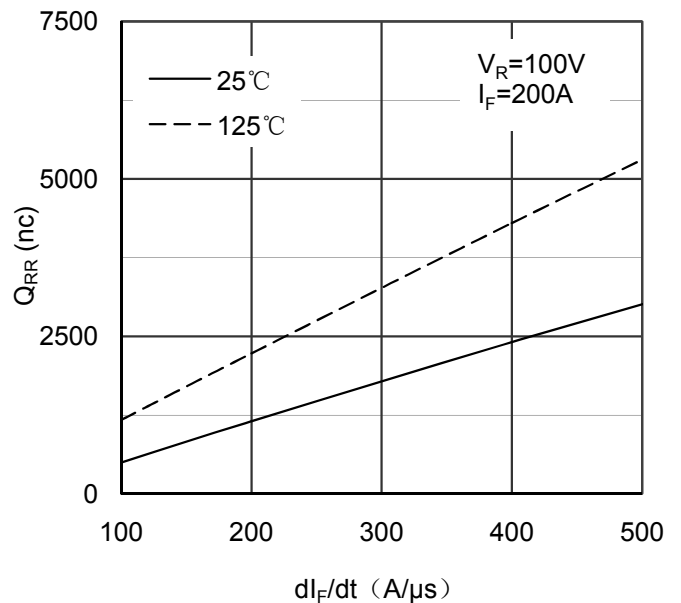

Figure 4. Reverse Recovery Charge vs di_F/dt

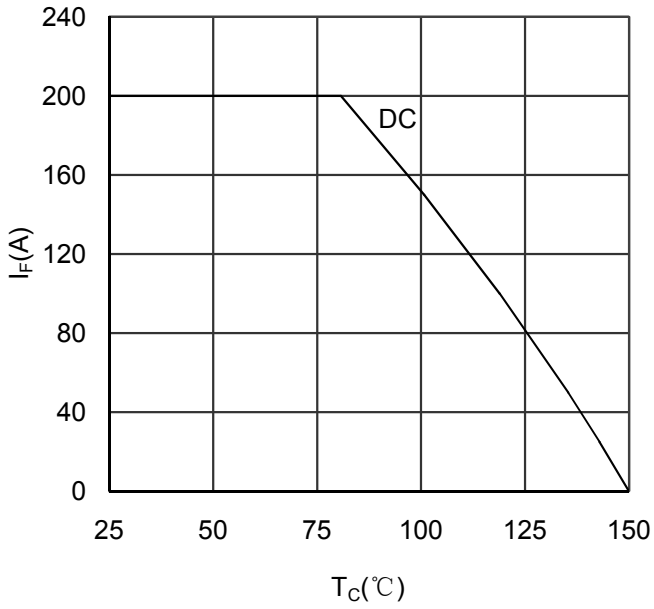

Figure 5. Forward current vs Case temperature

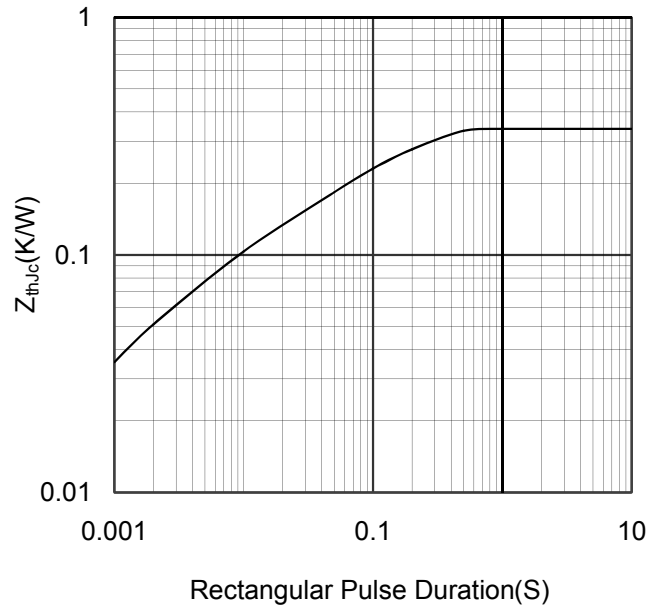
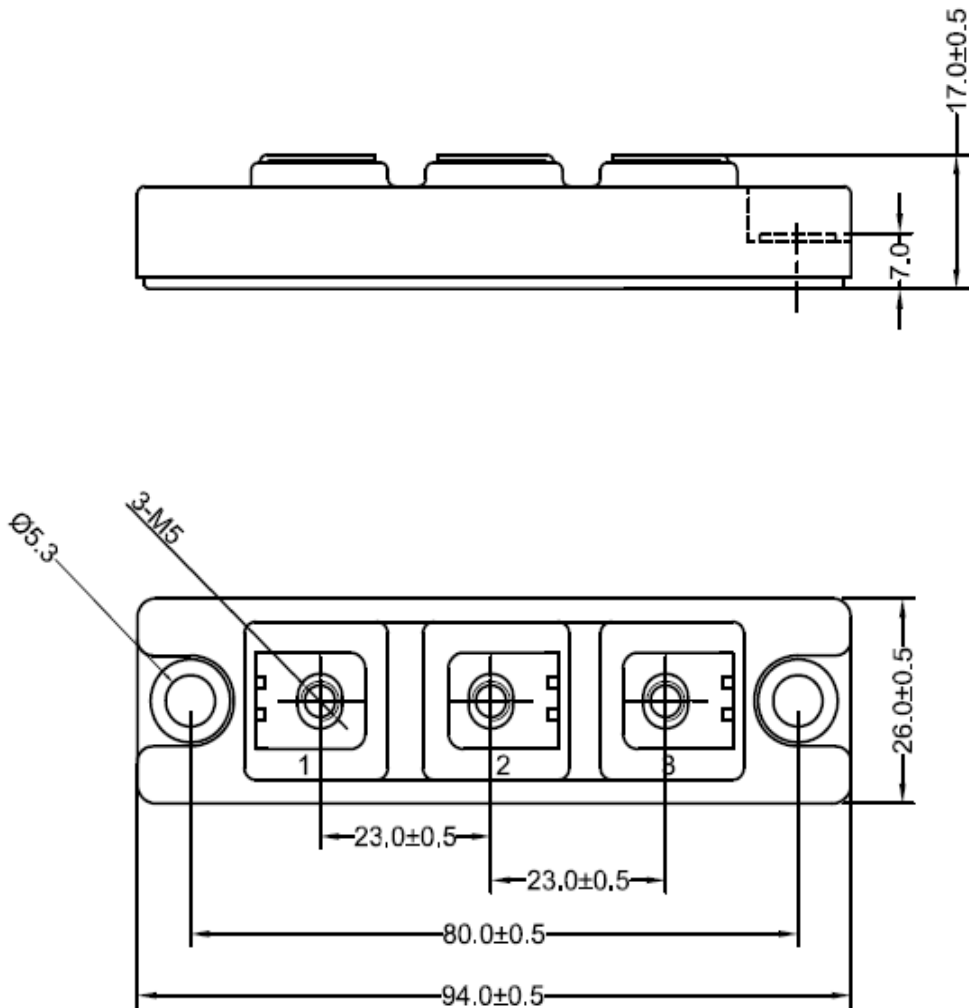

Figure 6. Transient Thermal Impedance



Dimensions in (mm)

Figure 7. Package Outline