

## PRODUCT FEATURES

- IGBT3 CHIP(1700V Trench+Field Stop technology)
- Low turn-off losses, short tail current
- $V_{CE(sat)}$  with positive temperature coefficient
- DIODE CHIP(1700V EMCON 3 technology)
- Free wheeling diodes with fast and soft reverse recovery
- Temperature sense included

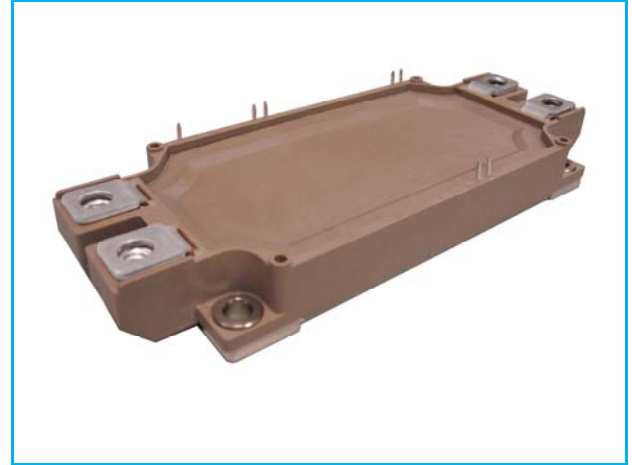

## APPLICATIONS

- AC motor control
- Motion/servo control
- Inverter and power supplies
- Photovoltaic/Fuel cell

### IGBT-inverter

ABSOLUTE MAXIMUM RATINGS( $T_C=25^\circ\text{C}$  unless otherwise specified)

Symbol	Parameter/Test Conditions	Values	Unit
$V_{CES}$	Collector Emitter Voltage	$T_J=25^\circ\text{C}$	V
$V_{GES}$	Gate Emitter Voltage		
$I_C$	DC Collector Current	$T_C=25^\circ\text{C}, T_{Jmax}=175^\circ\text{C}$	A
		$T_C=100^\circ\text{C}, T_{Jmax}=175^\circ\text{C}$	
$I_{CM}$	Repetitive Peak Collector Current	$t_p=1\text{ms}$	900
$P_{tot}$	Power Dissipation Per IGBT	$T_C=25^\circ\text{C}, T_{Jmax}=175^\circ\text{C}$	2700

### Diode-inverter

ABSOLUTE MAXIMUM RATINGS ( $T_C=25^\circ\text{C}$  unless otherwise specified)

Symbol	Parameter/Test Conditions	Values	Unit
$V_{RRM}$	Repetitive Reverse Voltage	$T_J=25^\circ\text{C}$	V
$I_{F(AV)}$	Average Forward Current		A
$I_{FRM}$	Repetitive Peak Forward Current	$t_p=1\text{ms}$	
$I^2t$		$T_J=125^\circ\text{C}, t=10\text{ms}, V_R=0\text{V}$	$\text{A}^2\text{S}$

MacMic Science & Technology Co., Ltd.

Add: #18, Hua Shan Zhong Lu, New District, Changzhou City, Jiangsu Province, P. R. of China

Tel.: +86-519-85163708 Fax: +86-519-85162291 Post Code: 213022 Website: www.macmicst.com

## MMG450WB170B6EN

### IGBT-inverter

#### ELECTRICAL CHARACTERISTICS ( $T_C=25^\circ\text{C}$ unless otherwise specified)

Symbol	Parameter/Test Conditions		Min.	Typ.	Max.	Unit
$V_{GE(th)}$	Gate Emitter Threshold Voltage	$V_{CE}=V_{GE}, I_C=18\text{mA}$	5.0	5.8	6.5	V
$V_{CE(sat)}$	Collector Emitter Saturation Voltage	$I_C=450\text{A}, V_{GE}=15\text{V}, T_J=25^\circ\text{C}$		2	2.45	
		$I_C=450\text{A}, V_{GE}=15\text{V}, T_J=125^\circ\text{C}$		2.4		
$I_{CES}$	Collector Leakage Current	$V_{CE}=1700\text{V}, V_{GE}=0\text{V}, T_J=25^\circ\text{C}$			3	mA
		$V_{CE}=1700\text{V}, V_{GE}=0\text{V}, T_J=125^\circ\text{C}$			20	mA
$I_{GES}$	Gate Leakage Current	$V_{CE}=0\text{V}, V_{GE}=\pm 15\text{V}, T_J=25^\circ\text{C}$	-400		400	nA
$R_{gint}$	Integrated Gate Resistor			1.7		$\Omega$
$Q_g$	Gate Charge	$V_{CE}=900\text{V}, I_C=450\text{A}, V_{GE}=\pm 15\text{V}$		5.1		$\mu\text{C}$
$C_{ies}$	Input Capacitance	$V_{CE}=25\text{V}, V_{GE}=0\text{V}, f=1\text{MHz}$		40.5		nF
$C_{res}$	Reverse Transfer Capacitance			1.3		nF
$t_{d(on)}$	Turn on Delay Time	$V_{CC}=900\text{V}, I_C=450\text{A}$ $R_G=3.3\Omega,$ $V_{GE}=\pm 15\text{V},$ Inductive Load	$T_J=25^\circ\text{C}$		280	ns
			$T_J=125^\circ\text{C}$		300	ns
$t_r$	Rise Time		$T_J=25^\circ\text{C}$		80	ns
			$T_J=125^\circ\text{C}$		100	ns
$t_{d(off)}$	Turn off Delay Time	$V_{CC}=900\text{V}, I_C=450\text{A}$ $R_G=3.3\Omega,$ $V_{GE}=\pm 15\text{V},$ Inductive Load	$T_J=25^\circ\text{C}$		810	ns
			$T_J=125^\circ\text{C}$		1000	ns
$t_f$	Fall Time		$T_J=25^\circ\text{C}$		180	ns
			$T_J=125^\circ\text{C}$		300	ns
$E_{on}$	Turn on Energy	$V_{CC}=900\text{V}, I_C=450\text{A}$ $R_G=3.3\Omega,$ $V_{GE}=\pm 15\text{V},$ Inductive Load	$T_J=25^\circ\text{C}$		96.5	mJ
			$T_J=125^\circ\text{C}$		140	mJ
$E_{off}$	Turn off Energy		$T_J=25^\circ\text{C}$		96	mJ
			$T_J=125^\circ\text{C}$		140	mJ
$I_{SC}$	Short Circuit Current	$t_{psc} \leq 10\mu\text{s}, V_{GE}=15\text{V}$ $T_J=125^\circ\text{C}, V_{CC}=1000\text{V}$		1800		A
$R_{thJC}$	Junction to Case Thermal Resistance ( Per IGBT )				0.055	K/W

### Diode-inverter

#### ELECTRICAL CHARACTERISTICS ( $T_C=25^\circ\text{C}$ unless otherwise specified)

Symbol	Parameter/Test Conditions		Min.	Typ.	Max.	Unit
$V_F$	Forward Voltage	$I_F=450\text{A}, V_{GE}=0\text{V}, T_J=25^\circ\text{C}$		1.8	2.2	V
		$I_F=450\text{A}, V_{GE}=0\text{V}, T_J=125^\circ\text{C}$		1.9		
$I_{RRM}$	Max. Reverse Recovery Current	$I_F=450\text{A}, V_R=900\text{V}$		570		A
$Q_{RR}$	Reverse Recovery Charge	$di_f/dt=-4500\text{A}/\mu\text{s}$ $T_J=125^\circ\text{C}$		195		$\mu\text{C}$
$E_{rec}$	Reverse Recovery Energy			110		mJ
$R_{thJCD}$	Junction to Case Thermal Resistance ( Per Diode )				0.1	K/W

## MMG450WB170B6EN

### NTC CHARACTERISTICS ( $T_C=25^\circ\text{C}$ unless otherwise specified)

Symbol	Parameter/Test Conditions	Min.	Typ.	Max.	Unit
$R_{25}$	Resistance $T_C=25^\circ\text{C}$		5		$\text{K}\Omega$
$B_{25/50}$	$R_2 = R_{25} \exp [B_{25/50}(1/T_2 - 1/(298.15 \text{ K}))]$		3375		K

### MODULE CHARACTERISTICS ( $T_C=25^\circ\text{C}$ unless otherwise specified)

Symbol	Parameter/Test Conditions	Values	Unit	
$T_{Jmax}$	Max. Junction Temperature	175	$^\circ\text{C}$	
$T_{Jop}$	Operating Temperature	-40~150		
$T_{stg}$	Storage Temperature	-40~125		
$V_{isol}$	Isolation Breakdown Voltage	AC, 50Hz(R.M.S), t=1minute	4000	V
CTI	Comparative Tracking Index		> 225	
Torque	to heatsink	Recommended (M5)	2.5~5	Nm
	to terminal	Recommended (M6)	3~5	Nm
Weight			350	g

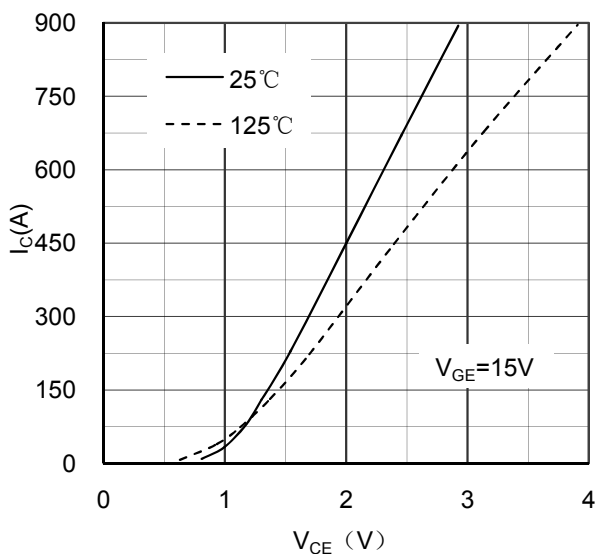

Figure 1. Typical Output Characteristics IGBT-inverter

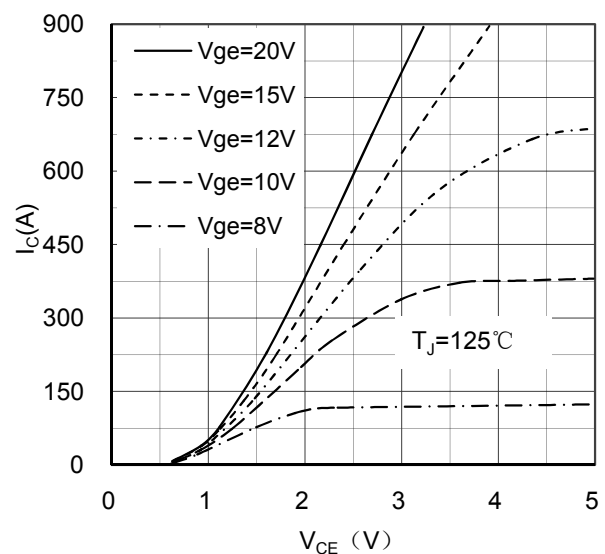

Figure 2. Typical Output Characteristics IGBT-inverter

# MMG450WB170B6EN

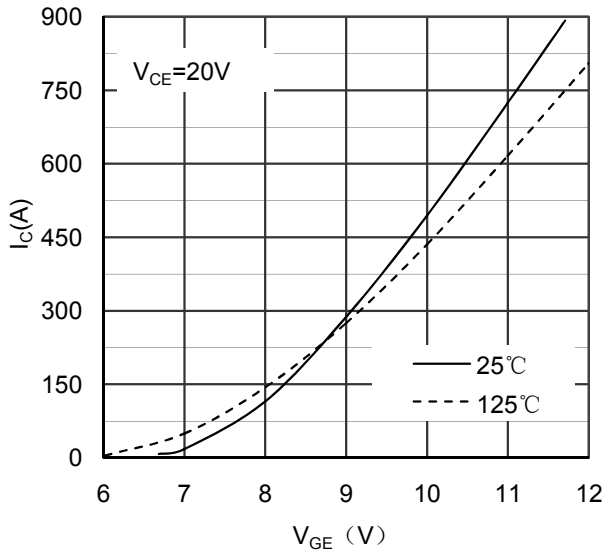

Figure 3. Typical Transfer characteristics IGBT-inverter

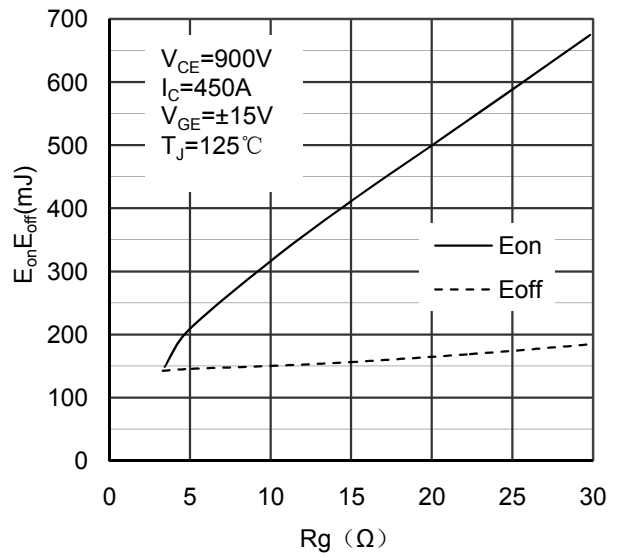

Figure 4. Switching Energy vs Gate Resistor IGBT-inverter

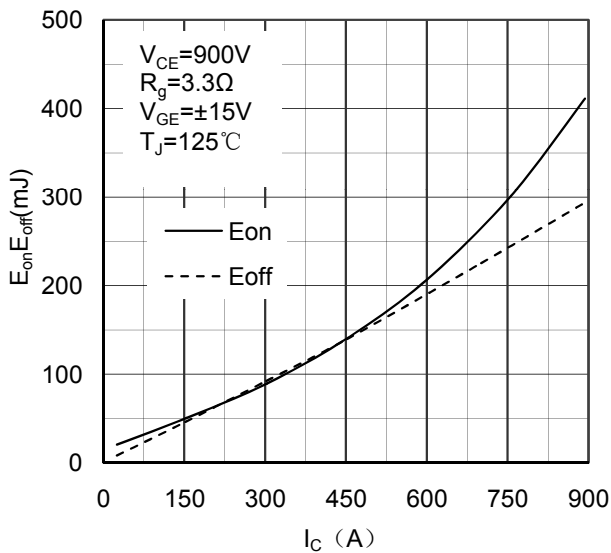

Figure 5. Switching Energy vs Collector Current IGBT-inverter

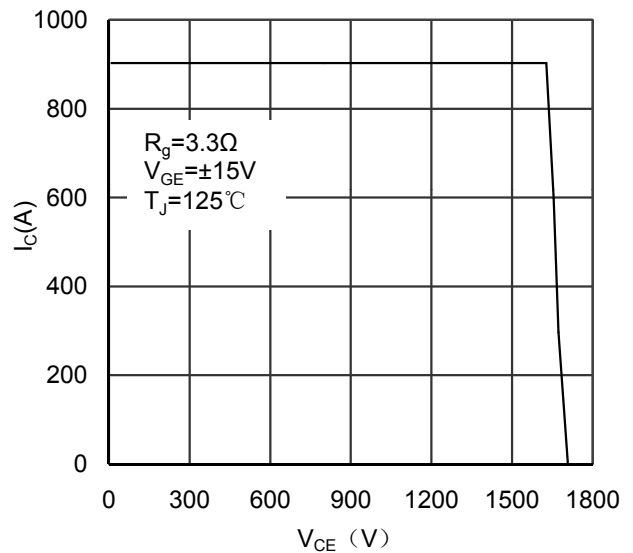

Figure 6. Reverse Biased Safe Operating Area IGBT-inverter

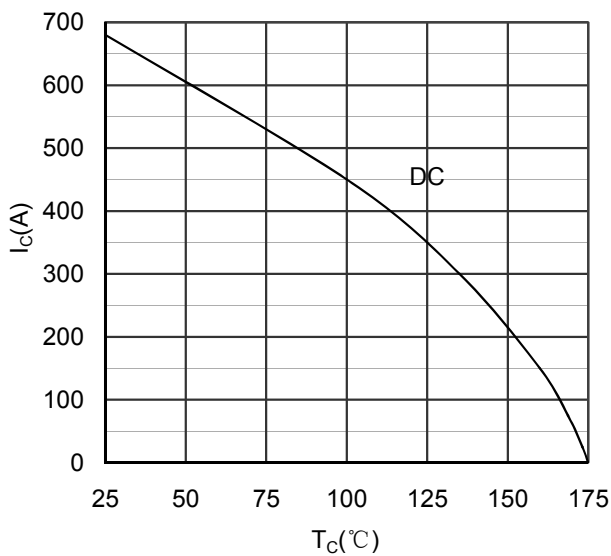

Figure 7. Collector Current vs Case temperature IGBT-inverter

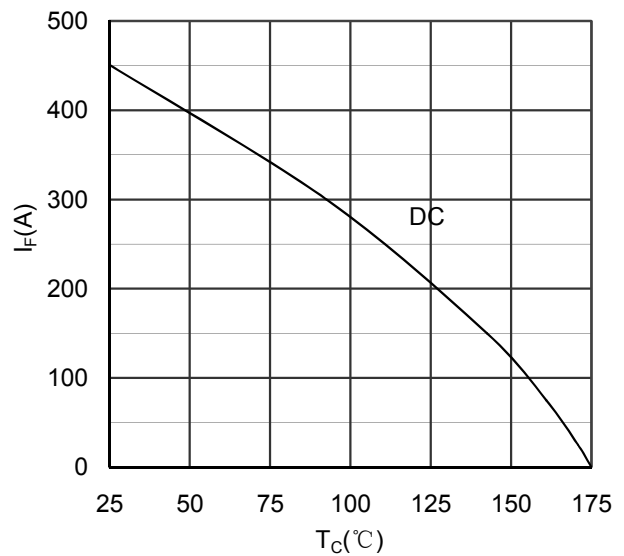

Figure 8. Forward current vs Case temperature Diode-inverter

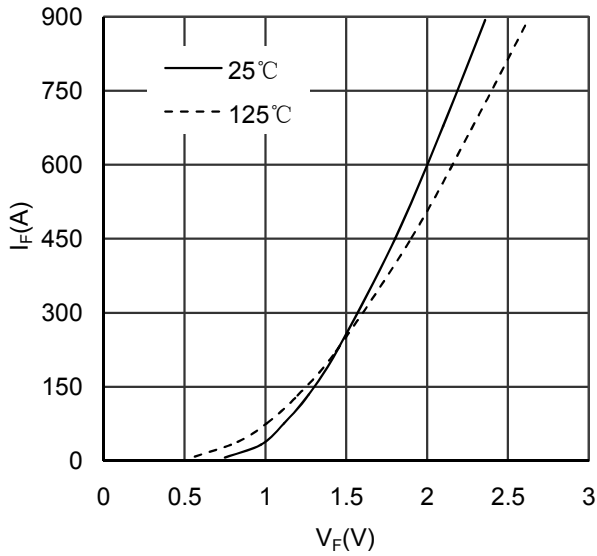

Figure 9. Diode Forward Characteristics Diode -inverter

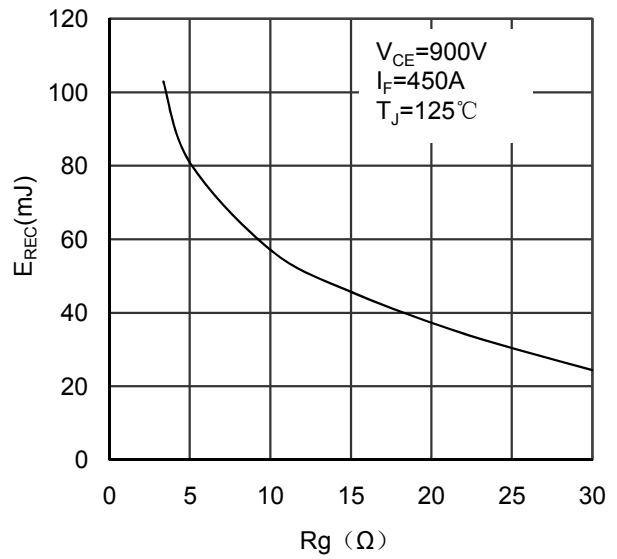

Figure 10. Switching Energy vs Gate Resistor Diode - inverter

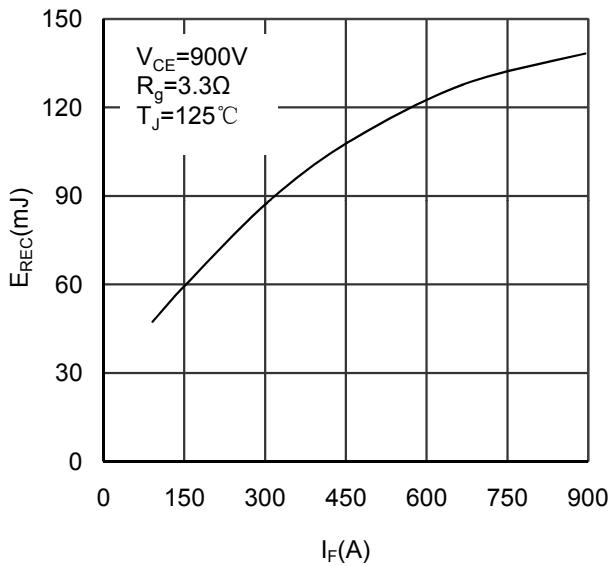

Figure 11. Switching Energy vs Forward Current Diode-inverter

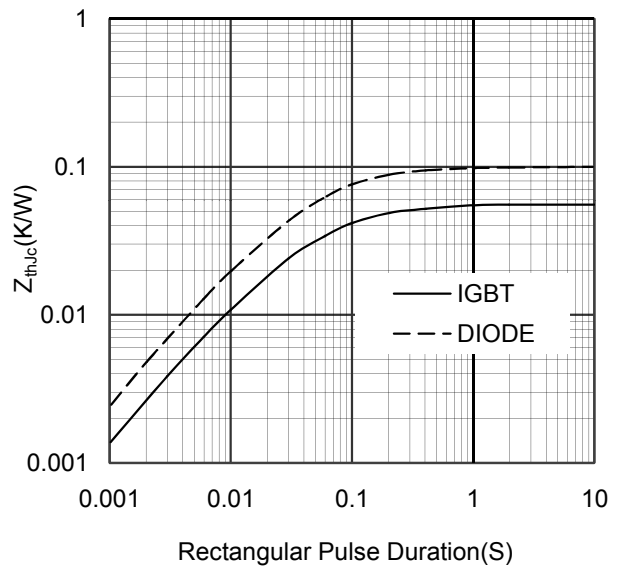

Figure 12. Transient Thermal Impedance of Diode and IGBT-inverter

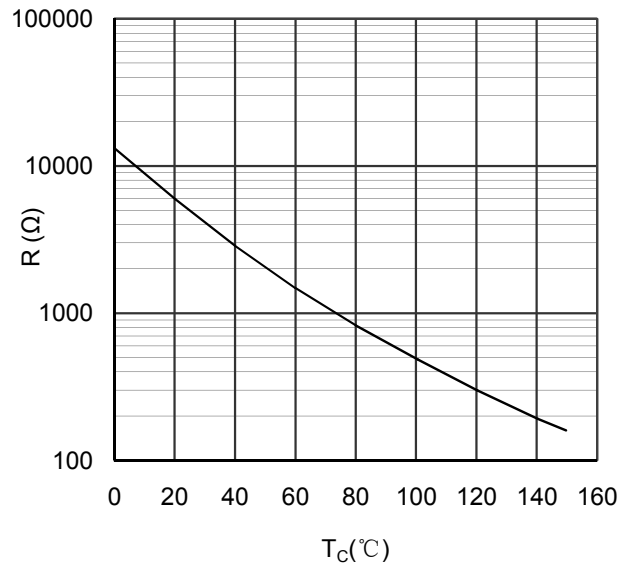

Figure 13. NTC Characteristics

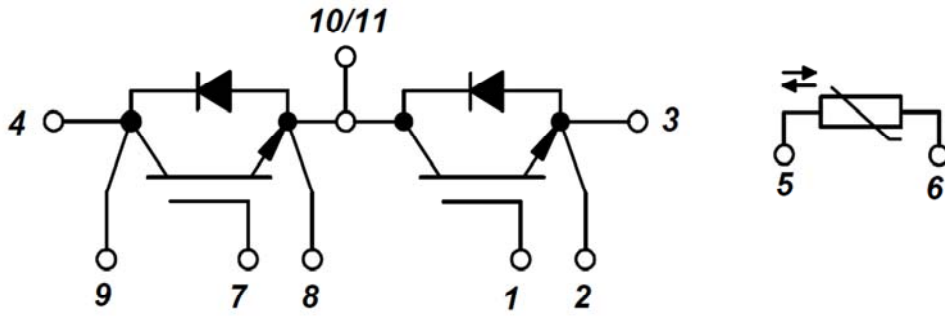
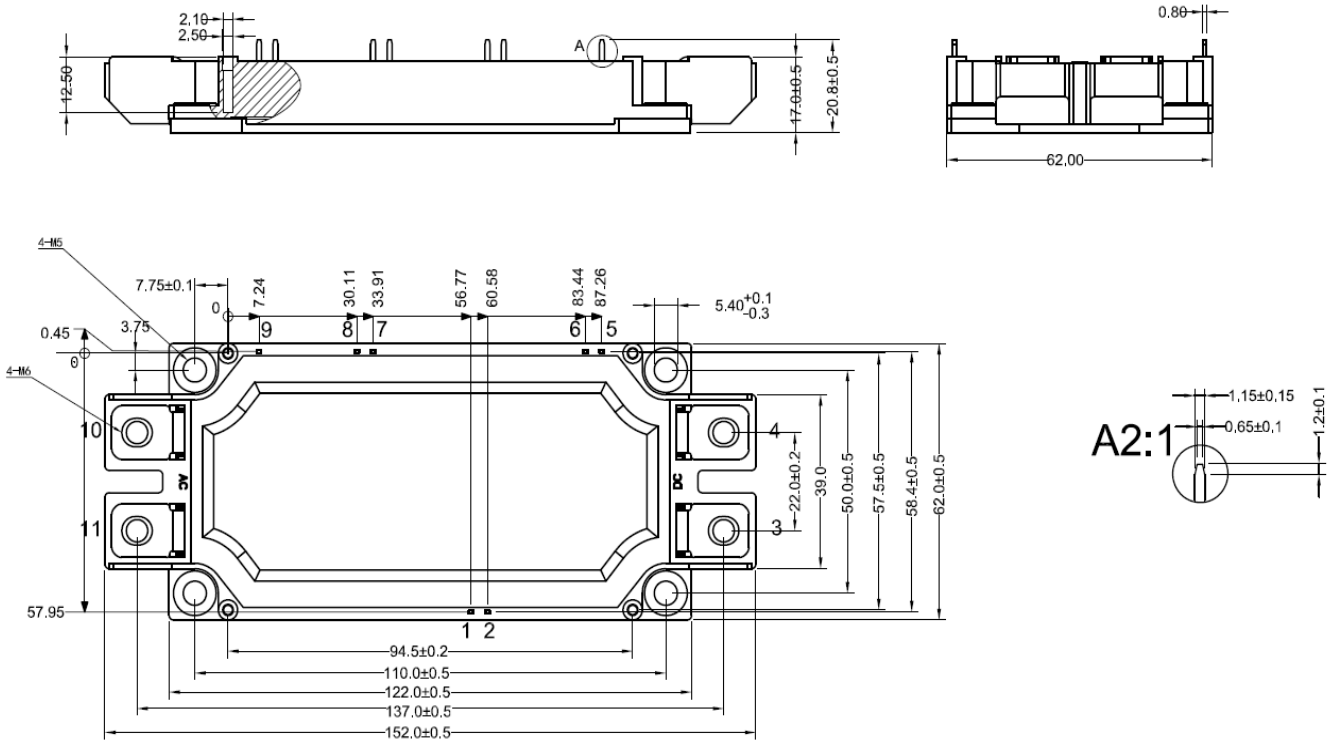

Figure 14. Circuit Diagram



Dimensions in (mm)

Figure 15. Package Outline