

PRODUCT FEATURES

- Substrate for Low Thermal Resistance
- Low saturation voltage and positive temperature coefficient
- Fast switching and short tail current
- Free wheeling diodes with fast and soft reverse recovery
- Solder Contact Technology, Rugged mounting due to integrated Mounting clamps
- Temperature sense included

APPLICATIONS

- AC motor control
- Motion/servo control
- Inverter and power supplies



Rectifier+Brake+Inverter

IGBT-inverter

ABSOLUTE MAXIMUM RATINGS ($T_C=25^{\circ}\text{C}$ unless otherwise specified)

Symbol	Parameter/Test Conditions		Values	Unit
V_{CES}	Collector Emitter Voltage	$T_J=25^{\circ}\text{C}$	1200	V
V_{GES}	Gate Emitter Voltage		± 20	
I_C	DC Collector Current	$T_C=25^{\circ}\text{C}$	54	A
		$T_C=100^{\circ}\text{C}$	35	
I_{CM}	Repetitive Peak Collector Current	$t_p=1\text{ms}$	70	
P_{tot}	Power Dissipation Per IGBT		215	W

Diode-inverter

ABSOLUTE MAXIMUM RATINGS ($T_C=25^{\circ}\text{C}$ unless otherwise specified)

Symbol	Parameter/Test Conditions		Values	Unit
V_{RRM}	Repetitive Reverse Voltage	$T_J=25^{\circ}\text{C}$	1200	V
$I_{F(AV)}$	Average Forward Current	$T_C=25^{\circ}\text{C}$	35	A
I_{FRM}	Repetitive Peak Forward Current	$t_p=1\text{ms}$	70	
I^2t		$T_J=125^{\circ}\text{C}, t=10\text{ms}, V_R=0\text{V}$	240	A^2S

MacMic Science & Technology Co., Ltd.

Add: #18, Hua Shan Zhong Lu, New District, Changzhou City, Jiangsu Province, P. R .of China

Tel.: +86-519-85163708 Fax: +86-519-85162291 Post Code: 213022 Website: www.macmicst.com

MMG35CE120XB6T4N

IGBT-inverter

ELECTRICAL CHARACTERISTICS ($T_C=25^{\circ}\text{C}$ unless otherwise specified)

Symbol	Parameter/Test Conditions		Min.	Typ.	Max.	Unit
$V_{GE(th)}$	Gate Emitter Threshold Voltage	$V_{CE}=V_{GE}, I_C=1.2\text{mA}$	5.2	5.8	6.4	V
$V_{CE(sat)}$	Collector Emitter Saturation Voltage	$I_C=35\text{A}, V_{GE}=15\text{V}, T_J=25^{\circ}\text{C}$		1.85	2.25	
		$I_C=35\text{A}, V_{GE}=15\text{V}, T_J=125^{\circ}\text{C}$		2.15		
		$I_C=35\text{A}, V_{GE}=15\text{V}, T_J=150^{\circ}\text{C}$		2.25		
I_{CES}	Collector Leakage Current	$V_{CE}=1200\text{V}, V_{GE}=0\text{V}, T_J=25^{\circ}\text{C}$			1	mA
I_{GES}	Gate Leakage Current	$V_{CE}=0\text{V}, V_{GE}=\pm 15\text{V}, T_J=25^{\circ}\text{C}$	-400		400	nA
R_{gint}	Integrated Gate Resistor			0		Ω
Q_g	Gate Charge	$V_{CE}=600\text{V}, I_C=35\text{A}, V_{GE}=\pm 15\text{V}$		0.27		μC
C_{ies}	Input Capacitance	$V_{CE}=25\text{V}, V_{GE}=0\text{V}, f=1\text{MHz}$		2		nF
C_{res}	Reverse Transfer Capacitance			0.07		nF
$t_{d(on)}$	Turn on Delay Time	$V_{CC}=600\text{V}, I_C=35\text{A},$ $R_G=12\Omega,$ $V_{GE}=\pm 15\text{V},$ Inductive Load	$T_J=25^{\circ}\text{C}$	25		ns
			$T_J=150^{\circ}\text{C}$	25		ns
t_r	Rise Time		$T_J=25^{\circ}\text{C}$	13		ns
			$T_J=150^{\circ}\text{C}$	18		ns
$t_{d(off)}$	Turn off Delay Time		$T_J=25^{\circ}\text{C}$	240		ns
			$T_J=150^{\circ}\text{C}$	310		ns
t_f	Fall Time	$T_J=25^{\circ}\text{C}$	115		ns	
		$T_J=150^{\circ}\text{C}$	200		ns	
E_{on}	Turn on Energy	$T_J=25^{\circ}\text{C}$	1.9		mJ	
		$T_J=125^{\circ}\text{C}$	2.9		mJ	
		$T_J=150^{\circ}\text{C}$	3.15		mJ	
E_{off}	Turn off Energy	$T_J=25^{\circ}\text{C}$	2		mJ	
		$T_J=125^{\circ}\text{C}$	2.9		mJ	
		$T_J=150^{\circ}\text{C}$	3.2		mJ	
I_{SC}	Short Circuit Current	$tp_{sc}\leq 10\mu\text{s}, V_{GE}=15\text{V}$ $T_J=150^{\circ}\text{C}, V_{CC}=900\text{V}$		130		A
R_{thJC}	Junction to Case Thermal Resistance (Per IGBT)			0.6	0.7	K/W

Diode-inverter

ELECTRICAL CHARACTERISTICS ($T_C=25^{\circ}\text{C}$ unless otherwise specified)

Symbol	Parameter/Test Conditions		Min.	Typ.	Max.	Unit
V_F	Forward Voltage	$I_F=35\text{A}, V_{GE}=0\text{V}, T_J=25^{\circ}\text{C}$		1.65	2.15	V
		$I_F=35\text{A}, V_{GE}=0\text{V}, T_J=125^{\circ}\text{C}$		1.65		
		$I_F=35\text{A}, V_{GE}=0\text{V}, T_J=150^{\circ}\text{C}$		1.65		
I_{RRM}	Max. Reverse Recovery Current	$I_F=35\text{A}, V_R=600\text{V}$		88		A
Q_{RR}	Reverse Recovery Charge	$dI_F/dt=-2500\text{A}/\mu\text{s}$ $T_J=150^{\circ}\text{C}$		7.5		μC
E_{rec}	Reverse Recovery Energy			2.95		mJ
R_{thJCD}	Junction to Case Thermal Resistance (Per Diode)			0.8	0.9	K/W

MMG35CE120XB6T4N

Diode-RECTIFIER

ABSOLUTE MAXIMUM RATINGS ($T_C=25^\circ\text{C}$ unless otherwise specified)

Symbol	Parameter/Test Conditions		Values	Unit
V_{RRM}	Repetitive Reverse Voltage	$T_J=25^\circ\text{C}$	1600	V
I_{FRMS}	R.M.S. Forward Current Per Diode	$T_C=100^\circ\text{C}$	60	A
I_{RMS}	R.M.S. Current at rectifier output		60	
I_{FSM}	Non Repetitive Surge Forward Current	$T_J=45^\circ\text{C}$, $t=10\text{ms}$, 50Hz	480	
		$T_J=45^\circ\text{C}$, $t=8.3\text{ms}$, 60Hz	527	
I^2t		$T_J=45^\circ\text{C}$, $t=10\text{ms}$, 50Hz	1152	A^2S
		$T_J=45^\circ\text{C}$, $t=8.3\text{ms}$, 60Hz	1152	

Diode-RECTIFIER

ELECTRICAL CHARACTERISTICS ($T_C=25^\circ\text{C}$ unless otherwise specified)

Symbol	Parameter/Test Conditions		Min.	Typ.	Max.	Unit
V_F	Forward Voltage	$I_F=35\text{A}$, $T_J=25^\circ\text{C}$		1.04	1.25	V
		$I_F=35\text{A}$, $T_J=150^\circ\text{C}$		0.97		
I_R	Reverse Leakage Current	$V_R=1600\text{V}$, $T_J=25^\circ\text{C}$		50	500	μA
		$V_R=1600\text{V}$, $T_J=150^\circ\text{C}$		1	10	mA
R_{thJCD}	Junction to Case Thermal Resistance (Per Diode)			0.8	0.9	K/W

IGBT-Brake chopper

ABSOLUTE MAXIMUM RATINGS ($T_C=25^\circ\text{C}$ unless otherwise specified)

Symbol	Parameter/Test Conditions		Values	Unit
V_{CES}	Collector Emitter Voltage	$T_J=25^\circ\text{C}$	1200	V
V_{GES}	Gate Emitter Voltage		± 20	
I_C	DC Collector Current	$T_C=25^\circ\text{C}$	54	A
		$T_C=100^\circ\text{C}$	35	
I_{CM}	Repetitive Peak Collector Current	$t_p=1\text{ms}$	70	
P_{tot}	Power Dissipation Per IGBT		215	W

Diode-Brake chopper

ABSOLUTE MAXIMUM RATINGS ($T_C=25^\circ\text{C}$ unless otherwise specified)

Symbol	Parameter/Test Conditions		Values	Unit
V_{RRM}	Repetitive Reverse Voltage	$T_J=25^\circ\text{C}$	1200	V
$I_{F(AV)}$	Average Forward Current	$T_C=25^\circ\text{C}$	15	A
I_{FRM}	Repetitive Peak Forward Current	$t_p=1\text{ms}$	30	
I^2t	$T_J=125^\circ\text{C}$, $t=10\text{ms}$, $V_R=0\text{V}$		60	A^2S

MMG35CE120XB6T4N

IGBT-Brake chopper

ELECTRICAL CHARACTERISTICS ($T_C=25^\circ\text{C}$ unless otherwise specified)

Symbol	Parameter/Test Conditions		Min.	Typ.	Max.	Unit
$V_{GE(th)}$	Gate Emitter Threshold Voltage	$V_{CE}=V_{GE}, I_C=1.2\text{mA}$	5.2	5.8	6.4	V
$V_{CE(sat)}$	Collector Emitter Saturation Voltage	$I_C=35\text{A}, V_{GE}=15\text{V}, T_J=25^\circ\text{C}$		1.85	2.25	
		$I_C=35\text{A}, V_{GE}=15\text{V}, T_J=125^\circ\text{C}$		2.15		
		$I_C=35\text{A}, V_{GE}=15\text{V}, T_J=150^\circ\text{C}$		2.25		
I_{CES}	Collector Leakage Current	$V_{CE}=1200\text{V}, V_{GE}=0\text{V}, T_J=25^\circ\text{C}$			1	mA
I_{GES}	Gate Leakage Current	$V_{CE}=0\text{V}, V_{GE}=\pm 15\text{V}, T_J=25^\circ\text{C}$	-400		400	nA
R_{gint}	Integrated Gate Resistor			0		Ω
Q_g	Gate Charge	$V_{CE}=600\text{V}, I_C=35\text{A}, V_{GE}=\pm 15\text{V}$		0.27		μC
C_{ies}	Input Capacitance	$V_{CE}=25\text{V}, V_{GE}=0\text{V}, f=1\text{MHz}$		2		nF
C_{res}	Reverse Transfer Capacitance			0.07		nF
$t_{d(on)}$	Turn on Delay Time	$V_{CC}=600\text{V}, I_C=35\text{A},$ $R_G=47\Omega,$ $V_{GE}=\pm 15\text{V},$ Inductive Load	$T_J=25^\circ\text{C}$	70		ns
			$T_J=150^\circ\text{C}$	70		ns
t_r	Rise Time		$T_J=25^\circ\text{C}$	45		ns
			$T_J=150^\circ\text{C}$	57		ns
$t_{d(off)}$	Turn off Delay Time	$T_J=25^\circ\text{C}$		280		ns
		$T_J=150^\circ\text{C}$		450		ns
t_f	Fall Time	$T_J=25^\circ\text{C}$		115		ns
		$T_J=150^\circ\text{C}$		205		ns
E_{on}	Turn on Energy	$T_J=25^\circ\text{C}$		5		mJ
		$T_J=125^\circ\text{C}$		6.5		mJ
		$T_J=150^\circ\text{C}$		7		mJ
E_{off}	Turn off Energy	$T_J=25^\circ\text{C}$		2.1		mJ
		$T_J=125^\circ\text{C}$		3.05		mJ
		$T_J=150^\circ\text{C}$		3.35		mJ
I_{SC}	Short Circuit Current	$tpsc \leq 10\mu\text{S}, V_{GE}=15\text{V}$ $T_J=150^\circ\text{C}, V_{CC}=900\text{V}$		130		A
R_{thJC}	Junction to Case Thermal Resistance (Per IGBT)			0.6	0.7	K /W

Diode-Brake chopper

ELECTRICAL CHARACTERISTICS ($T_C=25^\circ\text{C}$ unless otherwise specified)

Symbol	Parameter/Test Conditions		Min.	Typ.	Max.	Unit
V_F	Forward Voltage	$I_F=15\text{A}, V_{GE}=0\text{V}, T_J=25^\circ\text{C}$		1.65	2.15	V
		$I_F=15\text{A}, V_{GE}=0\text{V}, T_J=125^\circ\text{C}$		1.65		
		$I_F=15\text{A}, V_{GE}=0\text{V}, T_J=150^\circ\text{C}$		1.65		
I_{RRM}	Max. Reverse Recovery Current	$I_F=15\text{A}, V_R=600\text{V}$		22		A
Q_{RR}	Reverse Recovery Charge	$dI_F/dt=-500\text{A}/\mu\text{s}$		2.2		μC
E_{rec}	Reverse Recovery Energy	$T_J=150^\circ\text{C}$		1.2		mJ
R_{thJCD}	Junction to Case Thermal Resistance (Per Diode)			1.65	1.85	K /W

MMG35CE120XB6T4N

NTC CHARACTERISTICS ($T_C=25^\circ\text{C}$ unless otherwise specified)

Symbol	Parameter/Test Conditions	Min.	Typ.	Max.	Unit
R_{25}	Resistance $T_C=25^\circ\text{C}$		5		K Ω
$B_{25/50}$	$R_2 = R_{25} \exp [B_{25/50}(1/T_2 - 1/(298.15 \text{ K}))]$		3375		K

MODULE CHARACTERISTICS ($T_C=25^\circ\text{C}$ unless otherwise specified)

Symbol	Parameter/Test Conditions	Values	Unit
T_{Jmax}	Max. Junction Temperature	Inverter, Brake-Chopper	175
		Rectifier	150
T_{Jop}	Operating Temperature	-40~150	°C
T_{stg}	Storage Temperature	-40~125	
V_{isol}	Isolation Breakdown Voltage	AC, 50Hz(R.M.S), t=1minute	
CTI	Comparative Tracking Index		>200
F	Mounting Force Per Clamp		40~80
Weight			40
			g

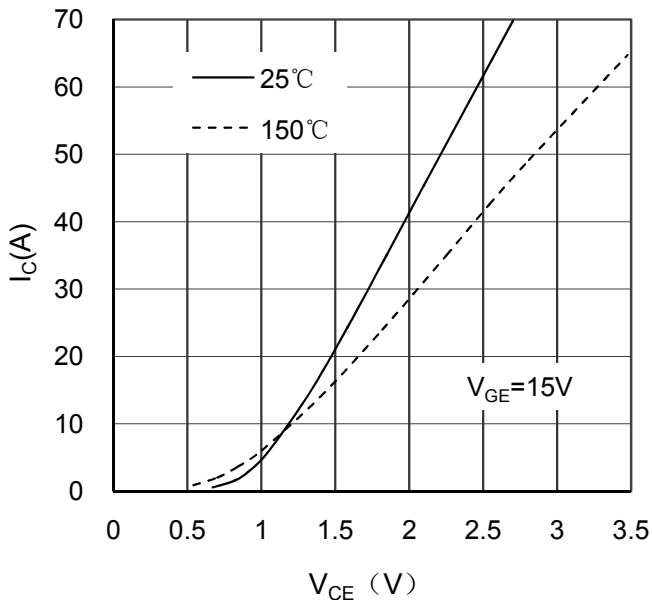

Figure 1. Typical Output Characteristics IGBT-inverter

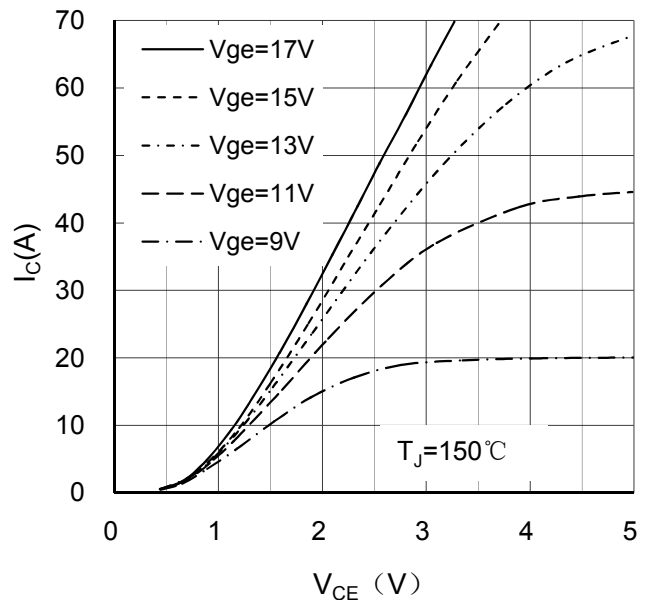

Figure 2. Typical Output Characteristics IGBT-inverter

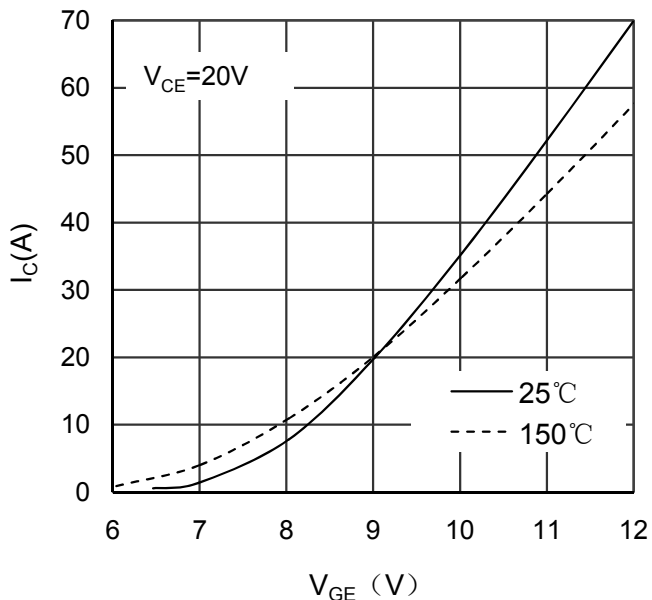

Figure 3. Typical Transfer characteristics IGBT-inverter

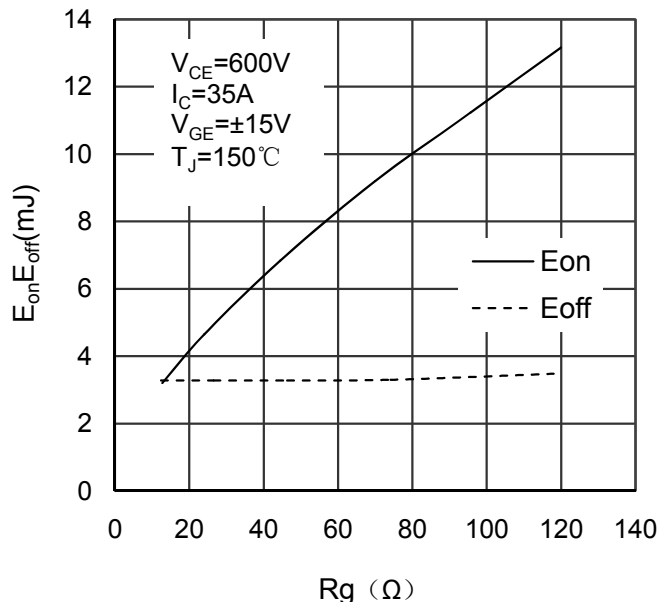

Figure 4. Switching Energy vs Gate Resistor IGBT-inverter

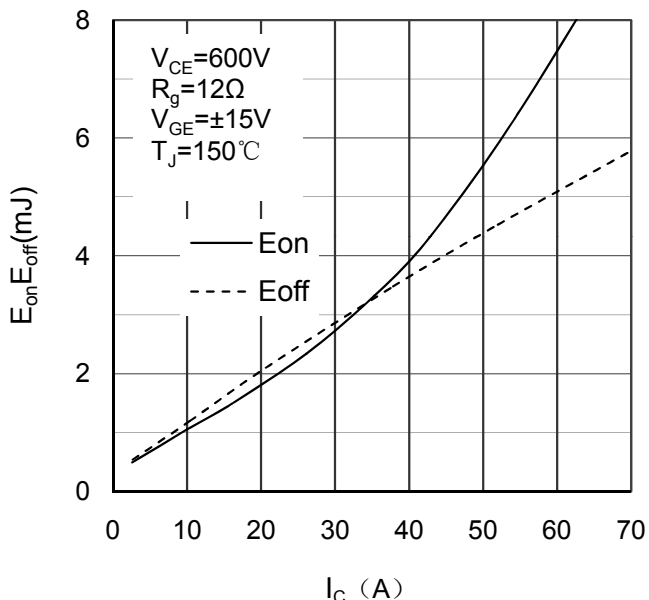

Figure 5. Switching Energy vs Collector Current IGBT-inverter

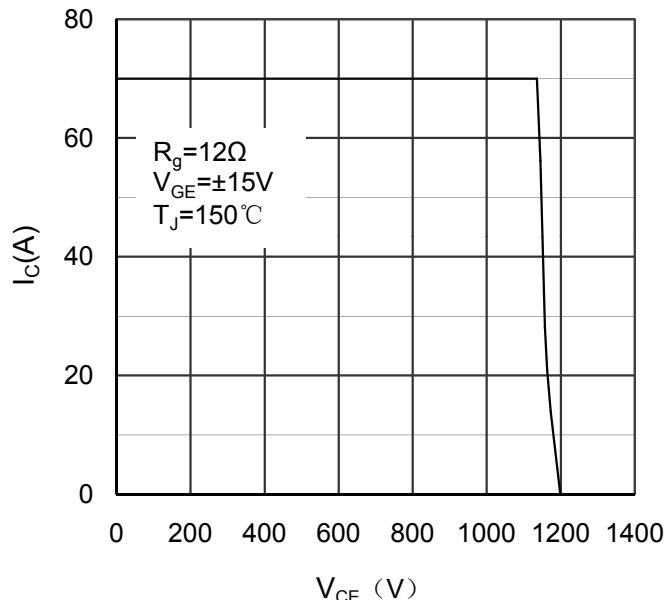

Figure 6. Reverse Biased Safe Operating Area IGBT-inverter

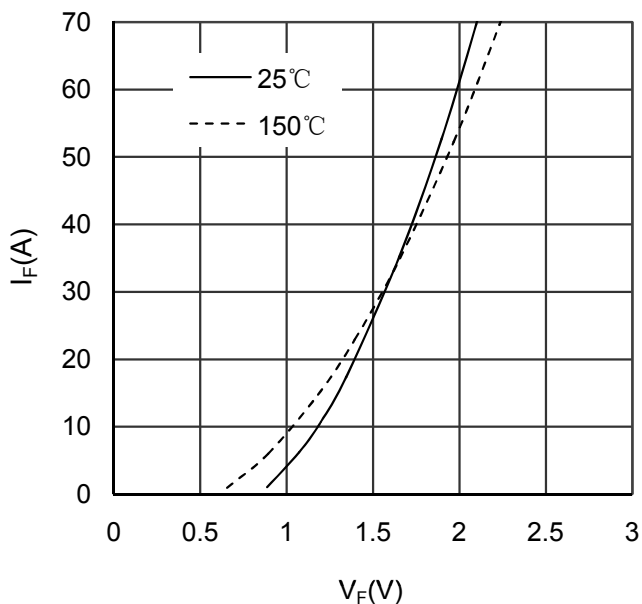

Figure 7. Diode Forward Characteristics Diode -inverter

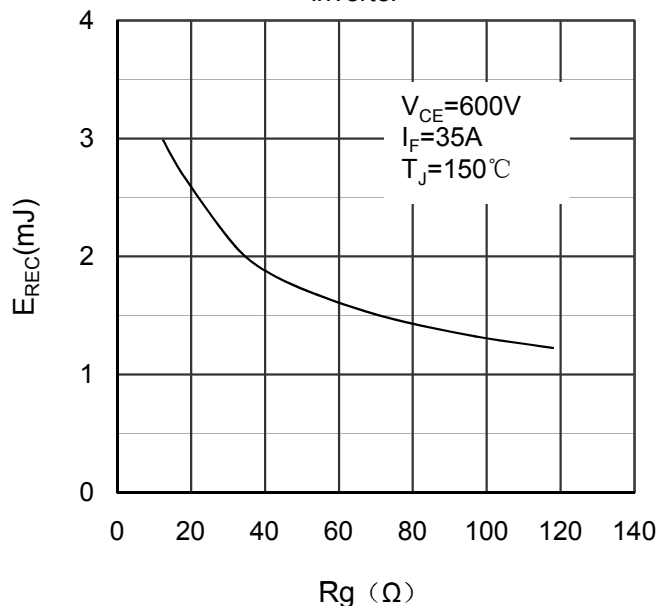

Figure 8. Switching Energy vs Gate Resistor Diode -inverter

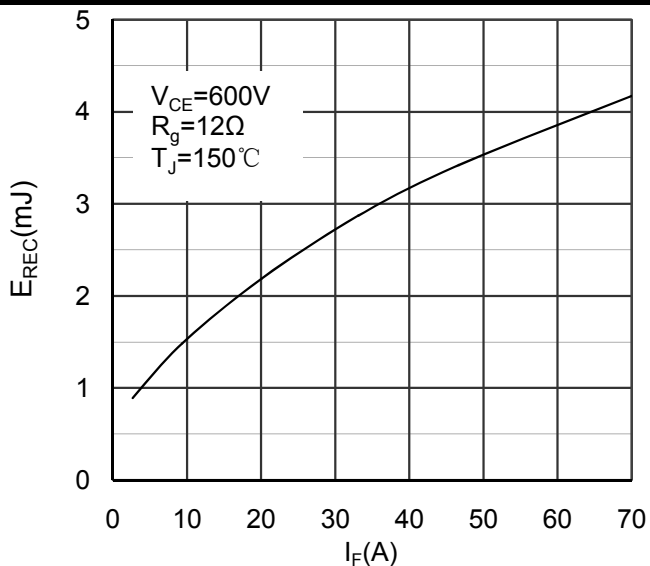

Figure 9. Switching Energy vs Forward Current Diode-inverter

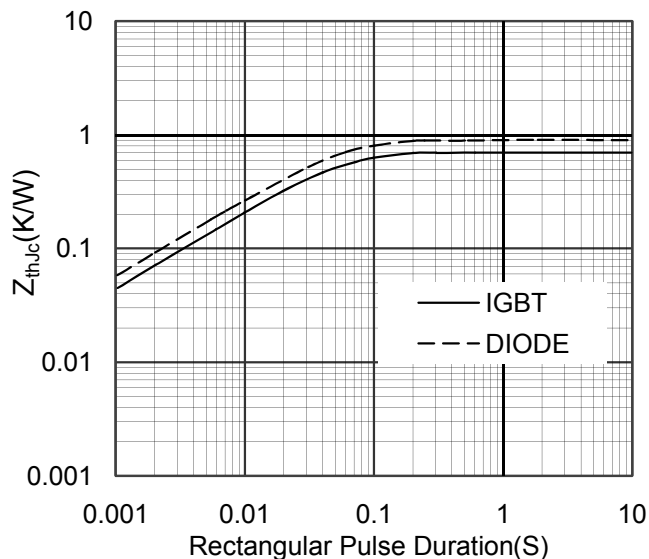

Figure 10. Transient Thermal Impedance of Diode and IGBT-inverter

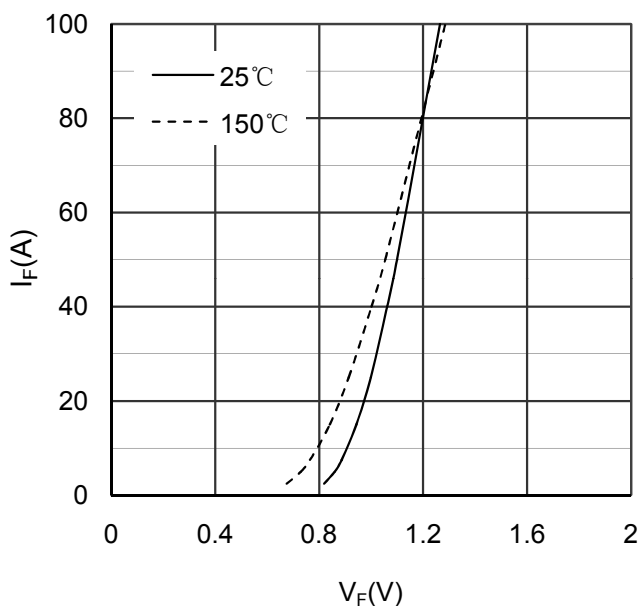

Figure 11. Diode Forward Characteristics Diode-rectifier

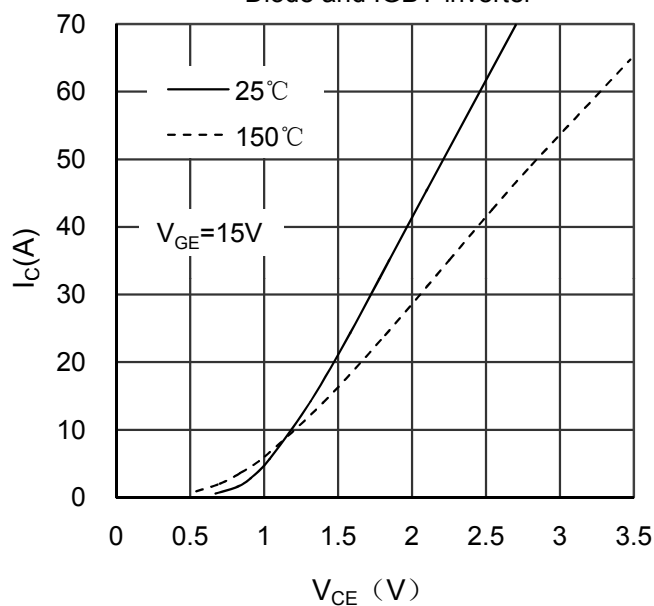

Figure 12. Typical Output Characteristics IGBT-brake chopper

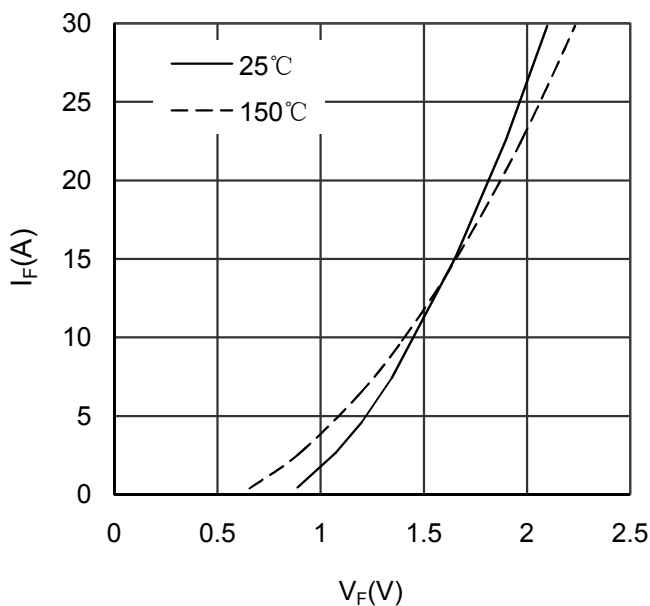

Figure 13. Diode Forward Characteristics Diode-brake chopper

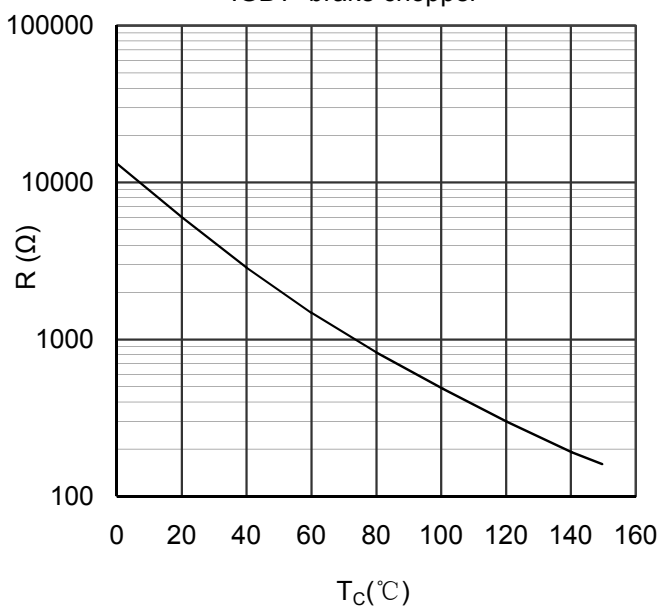

Figure 14. NTC Characteristics

MMG35CE120XB6T4N

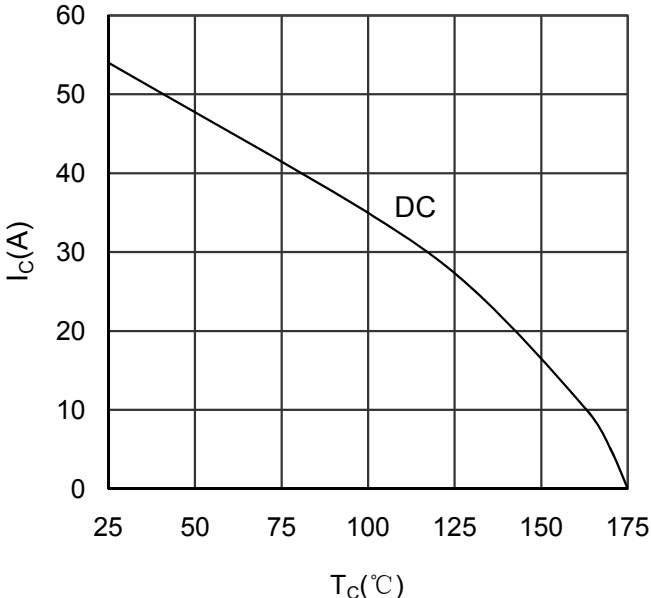

Figure 15. Collector Current vs Case temperature IGBT -inverter

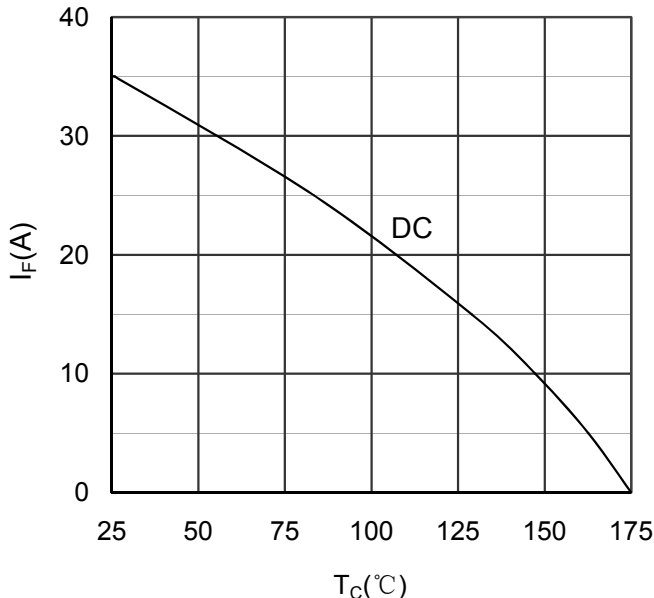

Figure 16. Forward current vs Case temperature Diode -inverter

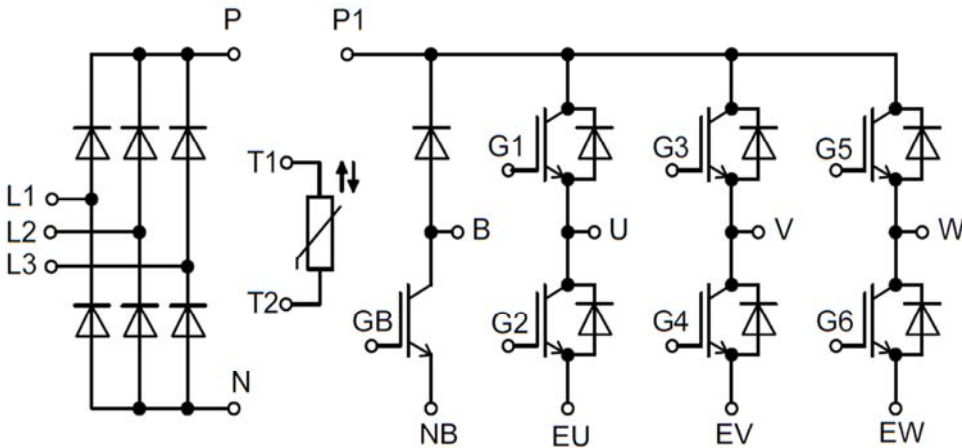
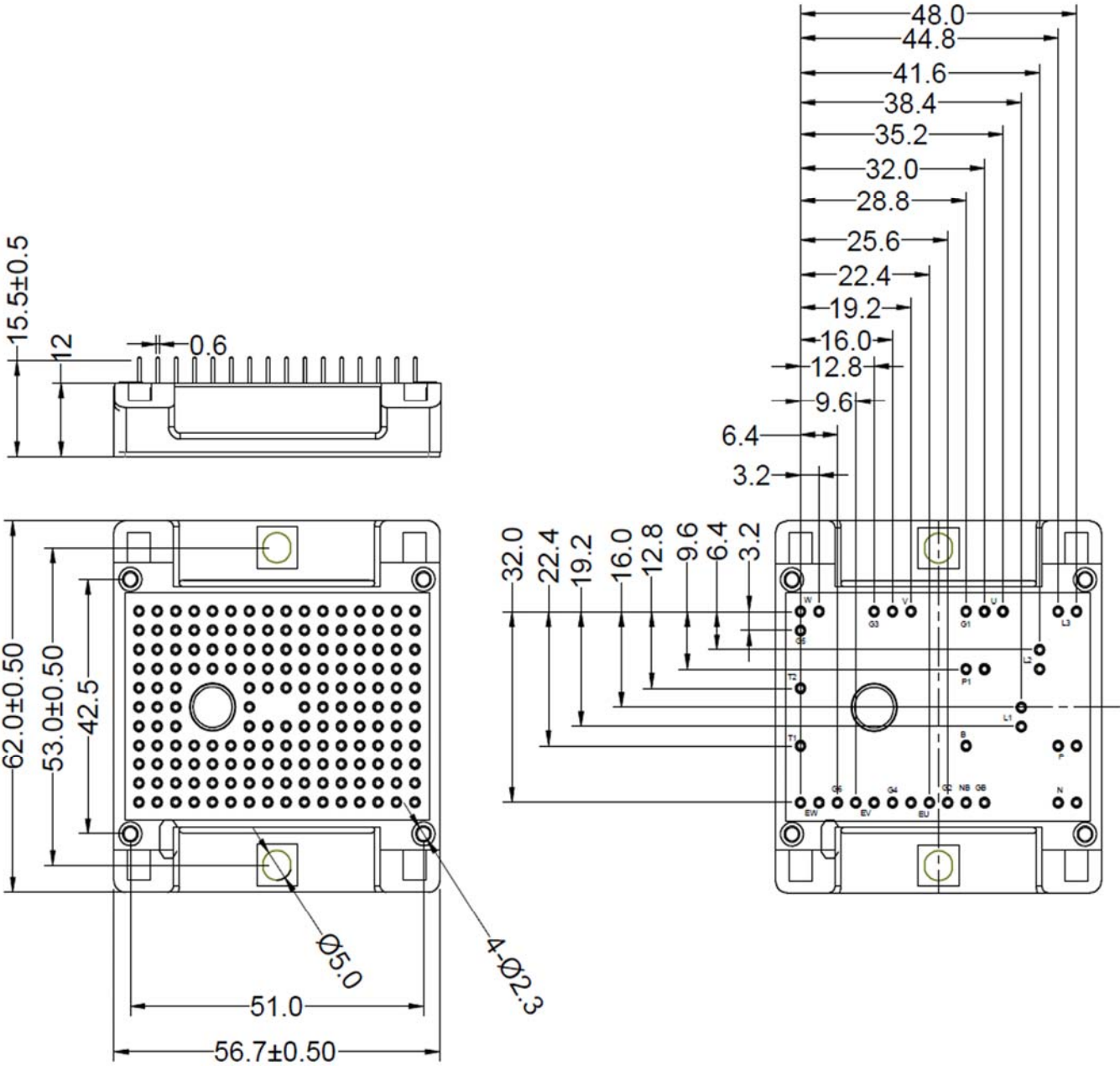

Figure 17. Circuit Diagram



Dimensions in (mm)
Figure 18. Package Outline