

PRODUCT FEATURES

- Ultrafast Reverse Recovery Time
- Soft Reverse Recovery Characteristics
- Low Reverse Recovery Loss
- Low Forward Voltage
- High Surge Current Capability
- Low Leakage Current



APPLICATIONS

- Inversion Welder
- Uninterruptible Power Supply
- Plating Power Supply
- Ultrasonic Cleaner and Welder
- Converter & Chopper
- PFC

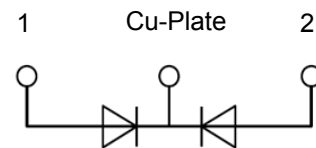

ABSOLUTE MAXIMUM RATINGS ($T_C=25^\circ\text{C}$ unless otherwise specified)

Symbol	Parameter/Test Conditions		Values	Unit
V_R	Maximum D.C. Reverse Voltage		400	V
V_{RRM}	Maximum Repetitive Reverse Voltage			
$I_{F(AV)}$	Average Forward Current	$T_C=100^\circ\text{C}$, Per Diode	100	A
		$T_C=100^\circ\text{C}$, Per Moudle	200	
$I_{F(RMS)}$	RMS Forward Current	$T_C=100^\circ\text{C}$, Per Diode	150	
I_{FSM}	Non Repetitive Surge Forward Current	$T_J=45^\circ\text{C}$, $t=10\text{ms}$, Sine, peak value	1250	
		$T_J=45^\circ\text{C}$, $t=8.3\text{ms}$, Sine, peak value	1350	
I^2t	For Fusing	$T_J=45^\circ\text{C}$, $t=10\text{ms}$, Sine, peak value	7812	A^2S
		$T_J=45^\circ\text{C}$, $t=8.3\text{ms}$, Sine, peak value	7563	
P_D	Power Dissipation		625	W
T_J	Junction Temperature		-40 to +150	$^\circ\text{C}$
T_{STG}	Storage Temperature Range		-40 to +125	$^\circ\text{C}$
Torque	Module to Sink	Recommended (M6)	3~4.7	Nm
Torque	Module Electrodes	Recommended (M6)	3~4.7	Nm
R_{thJC}	Junction to Case Thermal Resistance(Per Diode)		0.2	$^\circ\text{C}/\text{W}$
Weight			70	g

MacMic Science & Technology Co., Ltd.

Add: #18, Hua Shan Zhong Lu, New District, Changzhou City, Jiangsu Province, P. R. of China

Tel.: +86-519-85163708 Fax: +86-519-85162291 Post Code: 213022 Website: www.macmicst.com

MMF200ZB040DK1

ELECTRICAL CHARACTERISTICS ($T_C=25^\circ\text{C}$ unless otherwise specified)

Symbol	Parameter/Test Conditions	Min.	Typ.	Max.	Unit
I_{RM}	Maximum Reverse Leakage Current	$V_R=400\text{V}$		500	μA
		$V_R=400\text{V}, T_J=125^\circ\text{C}$		10	mA
V_F	Forward Voltage	$I_F=100\text{A}$	1		V
		$I_F=100\text{A}, T_J=125^\circ\text{C}$	0.9		
t_{rr}	Reverse Recovery Time ($I_F=1\text{A}, dI_F/dt=-200\text{A}/\mu\text{s}, V_R=30\text{V}$)		38		ns
t_{rr}	Reverse Recovery Time		70		ns
I_{RRM}	Maximum Reverse Recovery Current		11		
t_{rr}	Reverse Recovery Time		130		ns
I_{RRM}	Maximum Reverse Recovery Current		18		

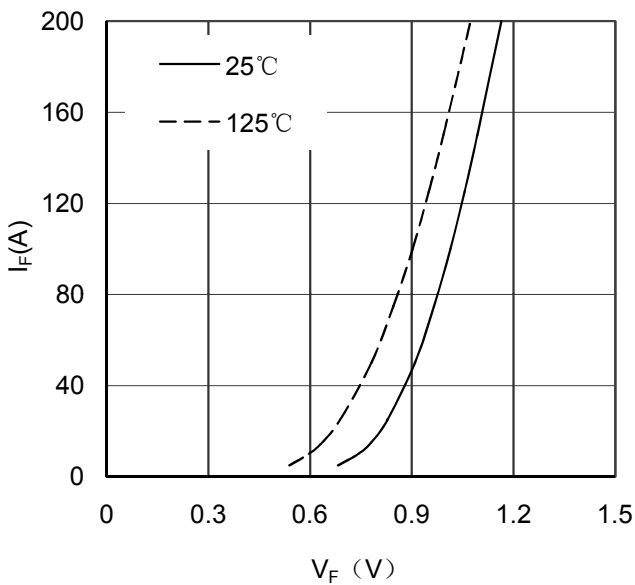

Figure 1. Forward Voltage Drop vs Forward Current

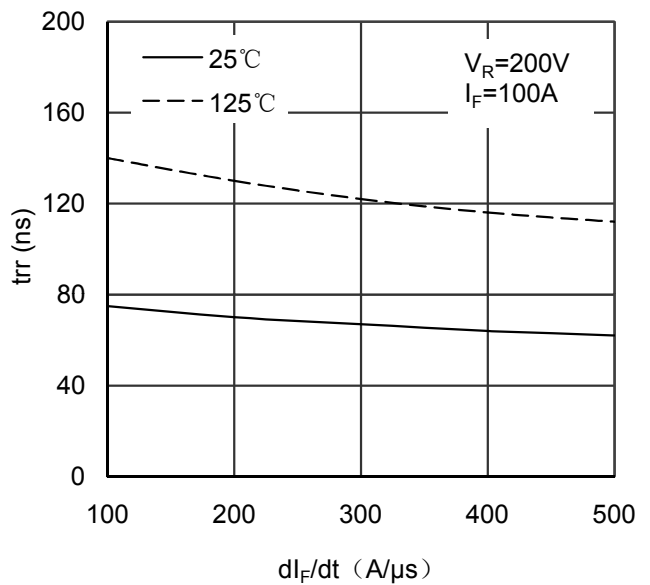

Figure 2. Reverse Recovery Time vs dI_F/dt

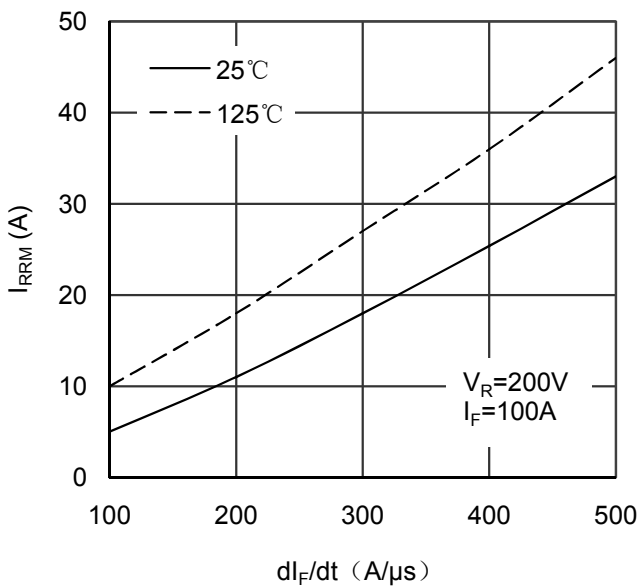

Figure 3. Reverse Recovery Current vs dI_F/dt

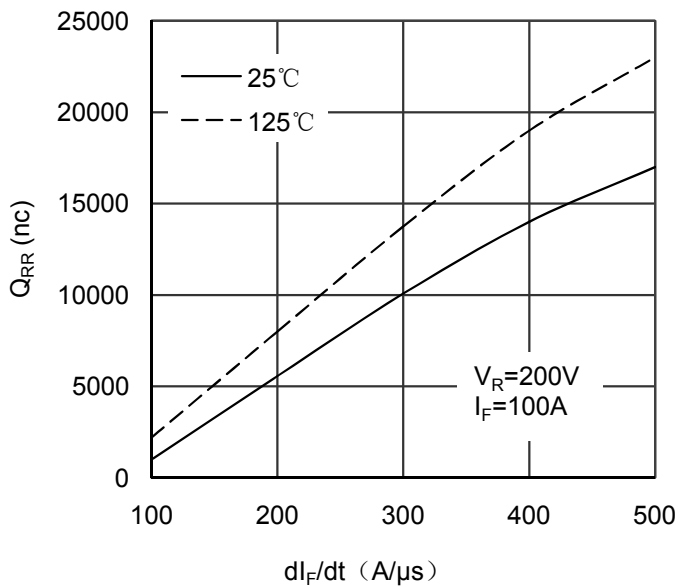

Figure 4. Reverse Recovery Charge vs dI_F/dt

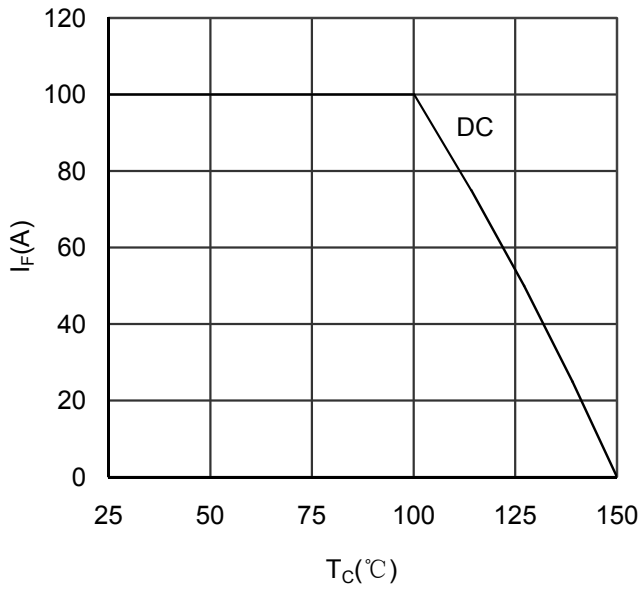

Figure 5. Forward current vs Case temperature

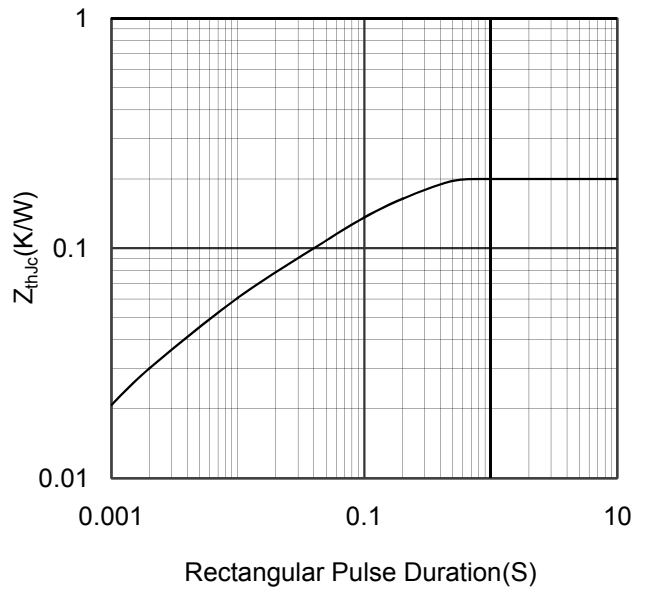
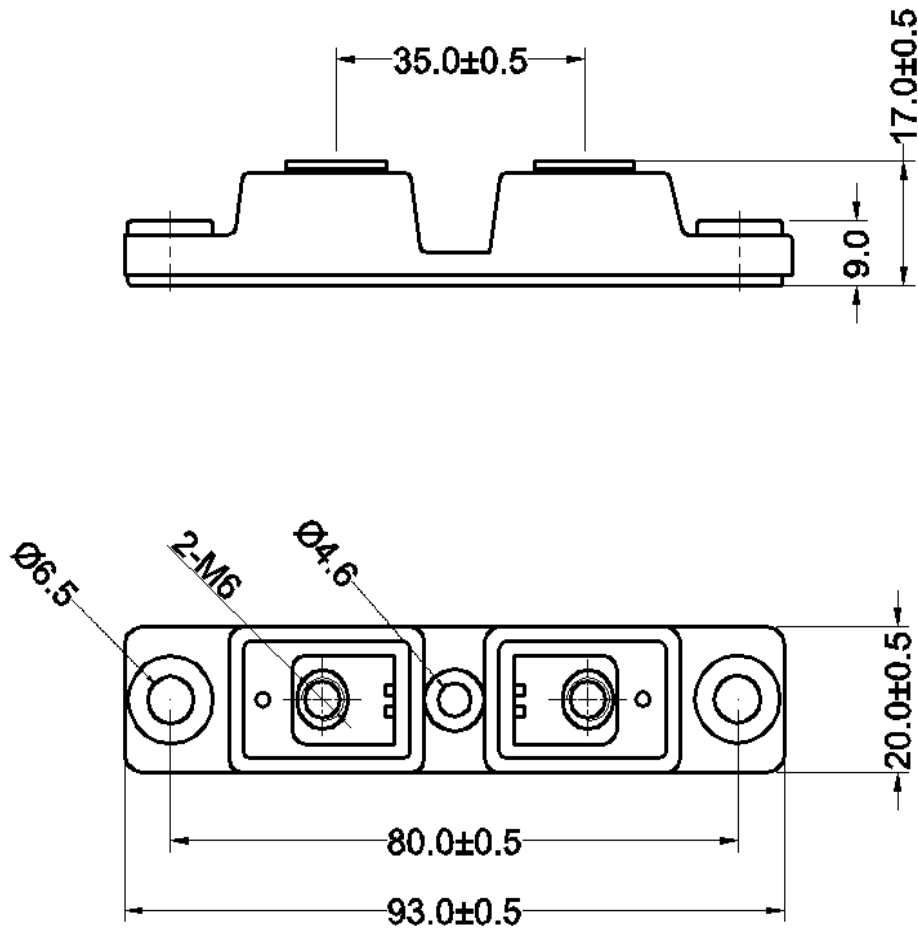

Figure 6. Transient Thermal Impedance



Dimensions in (mm)
Figure 7. Package Outline