

Features

- Isolation voltage 3500 V~
- Industrial Standard Package
- High Surge Capability
- Glass Passivated Chips
- Simple Mounting
- Electrically Isolated by DBC Ceramic



Applications

- DC Motor Control and Drives
- Battery Charges
- Welders
- Power Converters
- Lighting Control
- Heat and Temperature Control

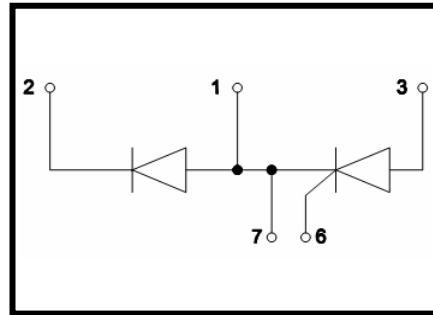

Advantages

- Space and weight savings
- Improved temperature and power cycling

ABSOLUTE MAXIMUM RATINGS

T_C=25°C unless otherwise specified

| Symbol | Test Condition | Value | Unit |
|------------------------------------|--|---------|--------------------|
| V _{RRM} | | 1600 | V |
| I _{T(AV)} | T _C =85°C, 180° conduction, half sine wave; | 90 | A |
| I _{T(RMS)} | as AC switch; | 190 | A |
| I _{TSM} | T _J =45°C, t=10ms (50Hz), sine, V _R =0; | 1500 | A |
| | T _J =45°C, t=8.3 ms (60Hz), sine, V _R =0; | 1650 | |
| | T _J =45°C, t=10ms (50Hz), sine, V _R =V _{RRM} ; | 1350 | |
| | T _J =45°C, t=8.3 ms (60Hz), sine, V _R = V _{RRM} ; | 1400 | |
| I ² t | T _J =45°C, t=10ms (50Hz), sine, V _R =0; | 11.2 | K A ² s |
| | T _J =45°C, t=8.3 ms (60Hz), sine, V _R =0; | 13.6 | |
| | T _J =45°C, t=10ms (50Hz), sine, V _R =V _{RRM} ; | 9.1 | |
| | T _J =45°C, t=8.3 ms (60Hz), sine, V _R = V _{RRM} ; | 9.8 | |
| I _{DRM} /I _{RSM} | T _J =130°C, V _D =V _R =1600V, gate open circuit; | 20 | mA |
| dV/dt | T _J =130°C, exponential to 67% rated V _{DRM} | 500 | V/us |
| V _{ISOL} | 50Hz, all terminals shorted, t=1s, I _{ISOL} ≤1mA ; | 3500 | V~ |
| T _J | Max. junction operating temperature range | -40~130 | °C |
| T _{STG} | Max. storage temperature range | -40~150 | °C |

ELECTRICAL CHARACTERISTICST_C=25°C unless otherwise specified

| Symbol | Test Condition | Min. | Typ. | Max. | Unit |
|---------------------|--|------|------|------|------|
| V _{TO} | 16.7% x p x I _{AV} < I < p x I _{AV} , T _J =130°C; | | | 0.80 | V |
| | I > p x I _{AV} , T _J =130°C; | | | 0.85 | V |
| r _t | 16.7% x p x I _{AV} < I < p x I _{AV} , T _J =130°C; | | | 2.37 | mΩ |
| | I > p x I _{AV} , T _J =130°C; | | | 2.25 | mΩ |
| I _H | V _{AK} = 6V, resistive load; | | | 250 | mA |
| I _L | Anode supply =6V, resistive load=1Ω, gate pulse =10V, 100us; | | | 400 | mA |
| V _{TM} | I _{TM} =282A, t _d =10 ms, half sine | | 1.60 | | V |
| P _{GM} | t _p ≤5ms, T _J =125°C; | | | 12 | W |
| P _{GM(AV)} | f=50Hz, T _J =125°C; | | | 3 | W |
| I _{GM} | t _p ≤5ms, T _J =125°C; | | | 3 | A |
| -V _{GT} | | | | 10 | V |
| V _{GT} | V _A =6V, R _A =1Ω, T _J =-40°C; | | | 4 | V |
| | V _A =6V, R _A =1Ω; | | | 2.5 | |
| | V _A =6V, R _A =1Ω, T _J =125°C; | | | 1.7 | |
| I _{GT} | V _A =6V, R _A =1Ω, T _J =-40°C; | | | 270 | mA |
| | V _A =6V, R _A =1Ω; | | | 150 | |
| | V _A =6V, R _A =1Ω, T _J =125°C; | | | 80 | |
| V _{GD} | V _{AK} =V _{DRM} , T _J =125°C | | | 0.25 | V |
| I _{GD} | | | | 6 | mA |
| di/dt | T _J = 25°C, V _D =0.67V _{DRM} , I _{TM} =345A, I _g = 500mA, tr < 0.5 μs, tp > 6 μs | | | 150 | A/us |

THERMAL AND MECHANICAL CHARACTERISTICST_C=25°C unless otherwise specified

| Symbol | Test Condition | value | Unit |
|-------------------|---|--------|------|
| R _{thjc} | DC operation,per junction; | 0.35 | K/W |
| R _{THCS} | Mounting surface smooth,flat and greased,per junction | 0.1 | K/W |
| Md | Mounting torque(M5) | 3 to 5 | N·m |
| | Terminal connection torque(M5) | | |
| Weight | Typical value | 105 | g |

Characteristic curves

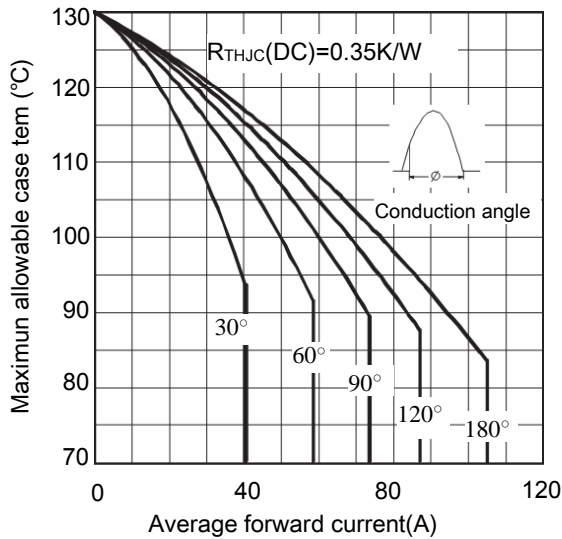

Figure 1. current rating characteristics

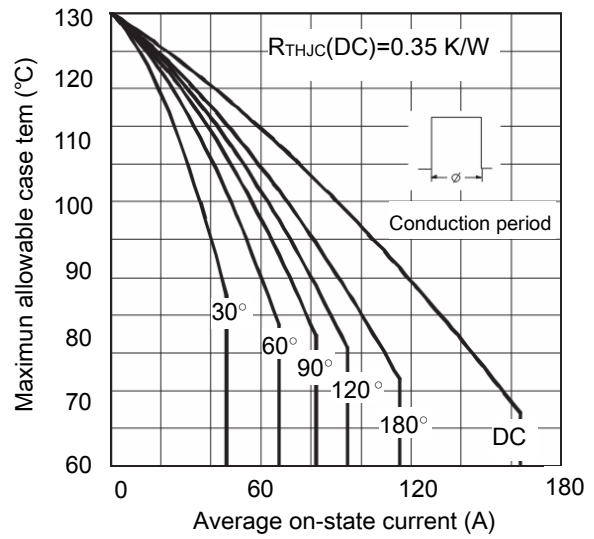

Figure 2. current rating characteristics

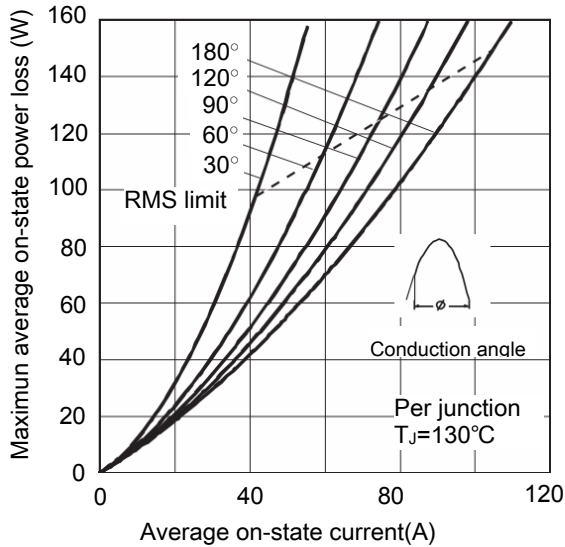

Figure 3. on-state power loss characteristics

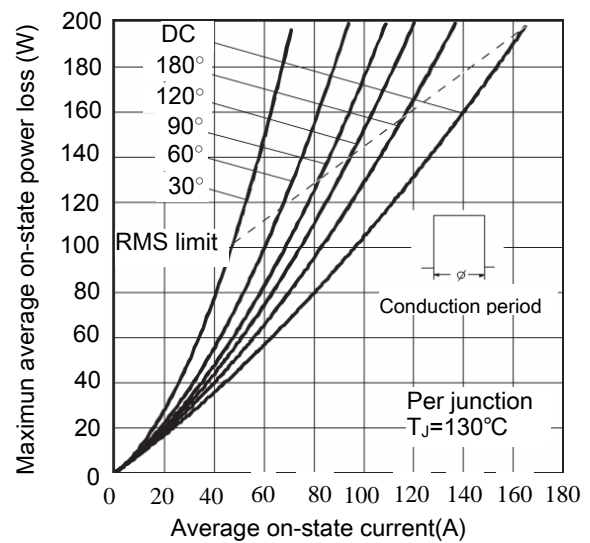

Figure 4. on-state power loss characteristics

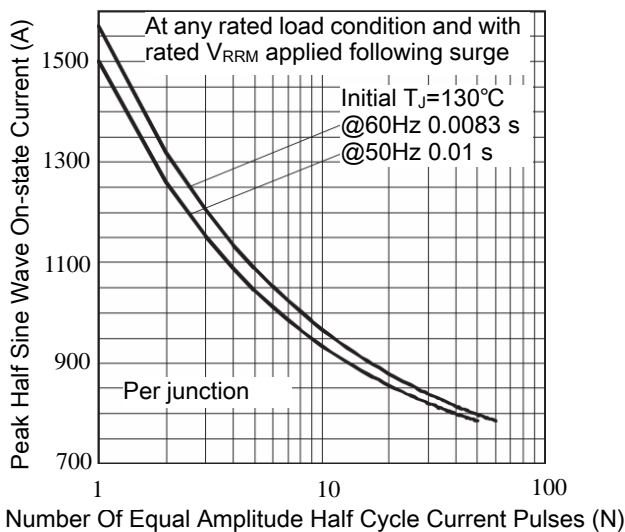

Figure 5. Maximum Non-Repetitive Surge Current

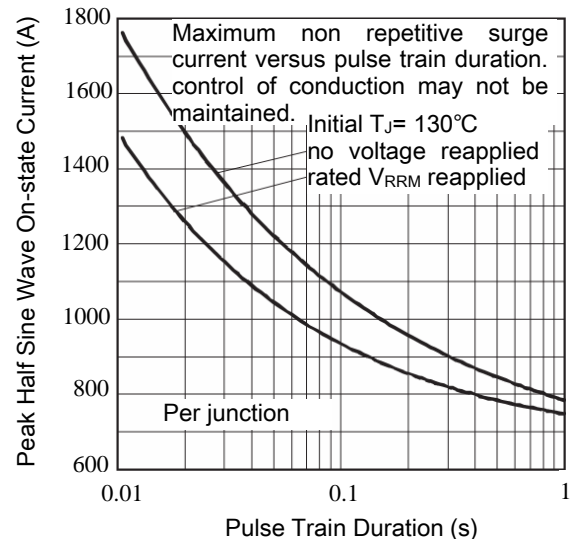

Figure 6. Maximum Non-Repetitive Surge Current

MMK90A160UK

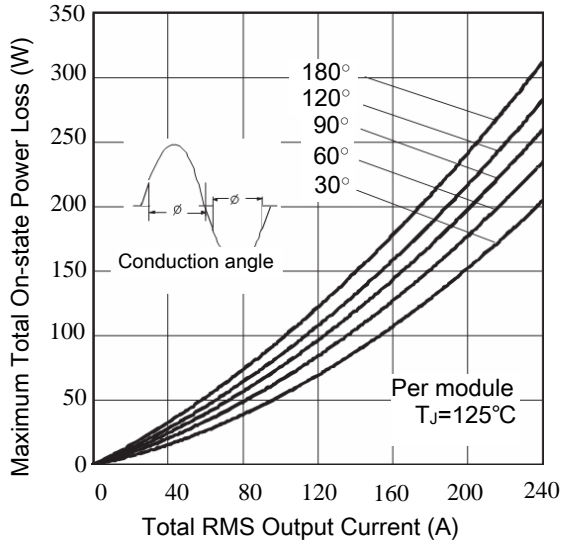

Figure 7. On-State Power Loss Characteristics-1

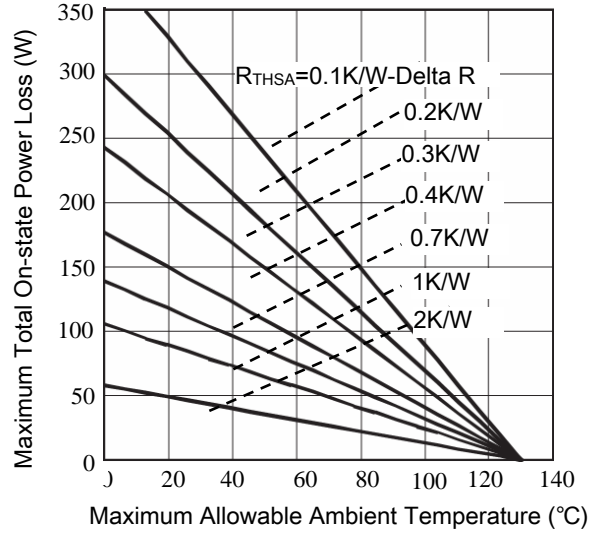

Figure.8 On-State Power Loss Characteristics-2

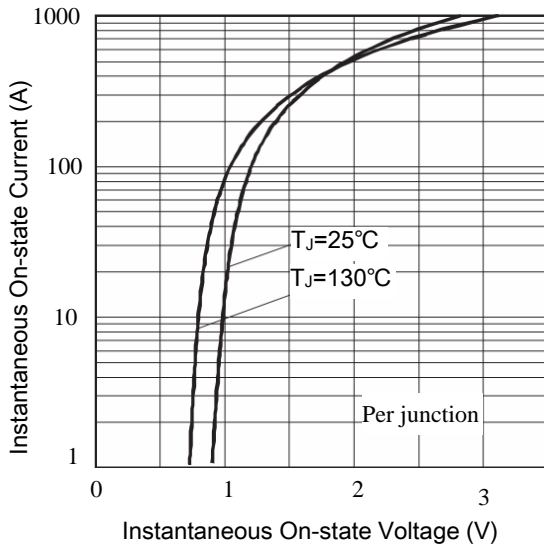

Figure.9 On State Voltage Drop Characteristics

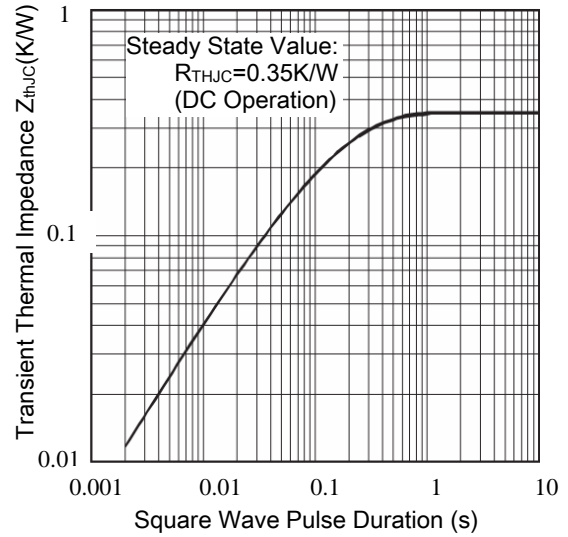

Figure.10 Thermal Impedance ZthJC Characteristics

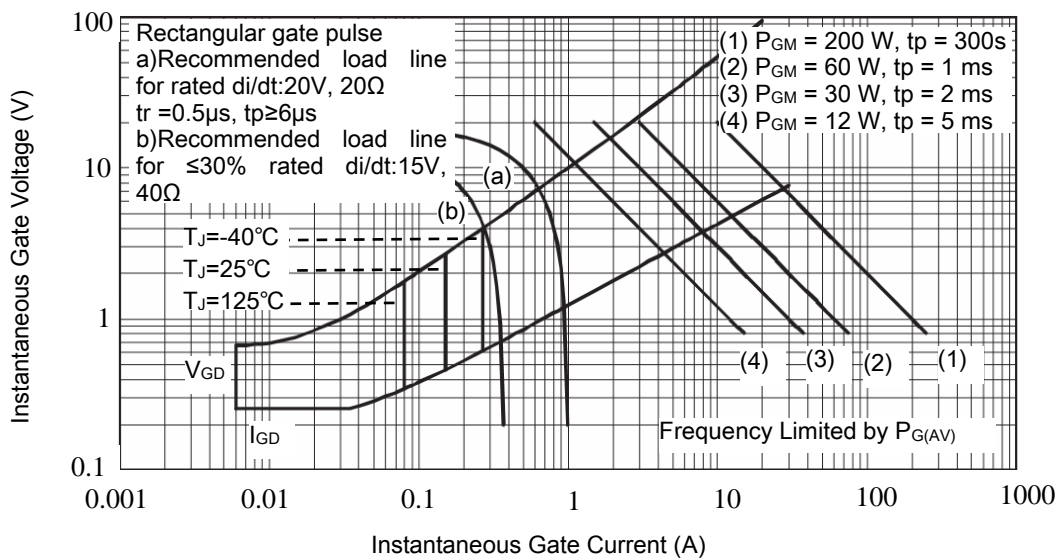

Figure.11 Gate Characteristics

Package Outline (Dimensions in mm)

