

Features

- Isolation Voltage 3000 V~
- Industrial Standard Package
- High Surge Capability
- Glass Passivated Chips
- Simple Mounting
- Electrically Isolated by DBC Ceramic



Applications

- DC Motor Control and Drives
- Battery Charges
- Welders
- Power Converters
- Lighting Control
- Heat and Temperature Control

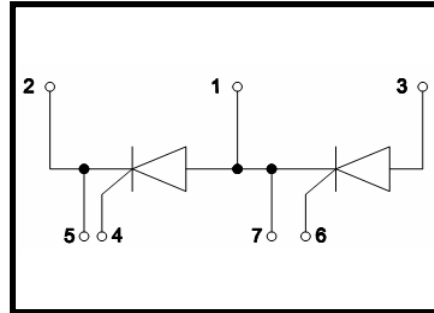

Advantages

- Space and Weight Savings
- Improved Temperature and Power Cycling

ABSOLUTE MAXIMUM RATINGS

$T_C=25^\circ\text{C}$ unless otherwise specified

Symbol	Test Condition	Value	Unit
V_{RRM}/V_{DRM}		1600	V
$I_{T(AV)}$	$T_C=85^\circ\text{C}$, 180° conduction, half sine wave;	160	A
$I_{T(RMS)}$	as AC switch;	355	A
I_{TSM}	$T_J=45^\circ\text{C}$, $t=10\text{ms}$ (50Hz), sine, $V_R=0$;	3000	A
	$T_J=45^\circ\text{C}$, $t=8.3\text{ms}$ (60Hz), sine, $V_R=0$;	3200	
I^2t	$T_J=45^\circ\text{C}$, $t=10\text{ms}$ (50Hz), sine, $V_R=0$;	45	KA ² s
	$T_J=45^\circ\text{C}$, $t=8.3\text{ms}$ (60Hz), sine, $V_R=0$;	42.5	
I_{DRM}/I_{RRM}	$V_R=V_{RRM}$, $V_D=V_{DRM}$, gate open circuit;	0.5	mA
	$T_J=125^\circ\text{C}$, $V_R=V_{RRM}$, $V_D=V_{DRM}$, gate open circuit;	40	mA
dV/dt	$T_J=125^\circ\text{C}$, exponential to 67% rated V_{DRM}	1000	V/us
V_{ISOL}	50Hz, all terminals shorted, $t=1\text{min}$, $I_{ISOL}\leq 1\text{mA}$;	3000	V~
T_J	Max. junction operating temperature range	-40~125	°C
T_{STG}	Max. storage temperature range	-40~125	°C

ELECTRICAL CHARACTERISTICS

 $T_C=25^{\circ}\text{C}$ unless otherwise specified

Symbol	Test Condition	Min.	Typ.	Max.	Unit
V_{TO}	$16.7\% \times I_{AV} < I < I_{AV}, T_J=125^{\circ}\text{C};$			0.80	V
	$I > I_{AV}, T_J=125^{\circ}\text{C};$			0.98	V
r_t	$16.7\% \times I_{AV} < I < I_{AV}, T_J=125^{\circ}\text{C};$			1.67	m Ω
	$I > I_{AV}, T_J=125^{\circ}\text{C};$			1.38	m Ω
I_H	$V_{AK}=6\text{V}, \text{initial } I_T=30\text{A};$			200	mA
I_L	Anode supply =6V, resistive load=1 Ω , gate pulse =10V, 100us;			400	mA
V_{TM}	$I_{TM}=500\text{A}, t_d=10 \text{ ms, half sine};$		1.54	2.0	V
P_{GM}	$t_p \leq 5\text{ms}, T_J=125^{\circ}\text{C};$			12	W
$P_{GM(AV)}$	$f=50\text{Hz}, T_J=125^{\circ}\text{C};$			3	W
I_{GM}	$t_p \leq 5\text{ms}, T_J=125^{\circ}\text{C};$			3	A
$-V_{GT}$				10	V
V_{GT}	$V_A=6\text{V}, R_A=1\Omega, T_J=-40^{\circ}\text{C};$			4	V
	$V_A=6\text{V}, R_A=1\Omega;$			2.5	
	$V_A=6\text{V}, R_A=1\Omega, T_J=125^{\circ}\text{C};$			1.7	
I_{GT}	$V_A=6\text{V}, R_A=1\Omega, T_J=-40^{\circ}\text{C};$			270	mA
	$V_A=6\text{V}, R_A=1\Omega;$			150	
	$V_A=6\text{V}, R_A=1\Omega, T_J=125^{\circ}\text{C};$			80	
V_{GD}	$V_{AK}=V_{DRM}, T_J=125^{\circ}\text{C}$			0.3	V
I_{GD}				10	mA
di/dt	$I_{TM}=400\text{A}, \text{rated } V_{DRM}, T_J=125^{\circ}\text{C}$			300	A/us

THERMAL AND MECHANICAL CHARACTERISTICS

 $T_C=25^{\circ}\text{C}$ unless otherwise specified

Symbol	Test Condition	value	Unit
R_{thjc}	DC operation, per junction;	0.18	K/W
R_{THCS}	Mounting surface smooth, flat and greased, per junction;	0.1	K/W
Md	Mounting torque(M6)	3 ~ 5	N·m
	Terminal connection torque(M6)		
Weight	Typical value	156	g

Characteristic curves

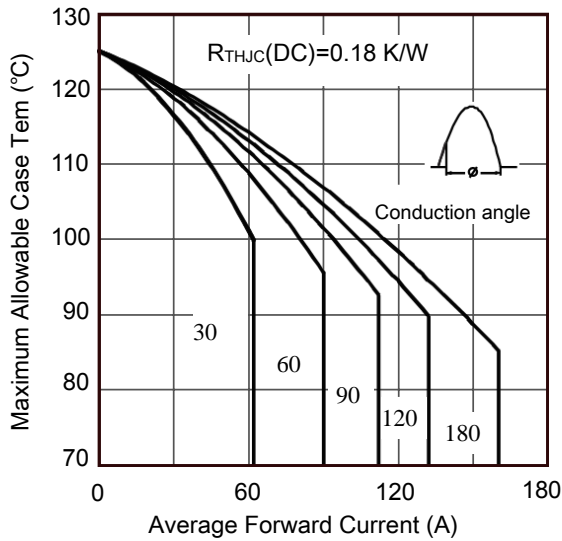

Figure 1. Current Rating Characteristics

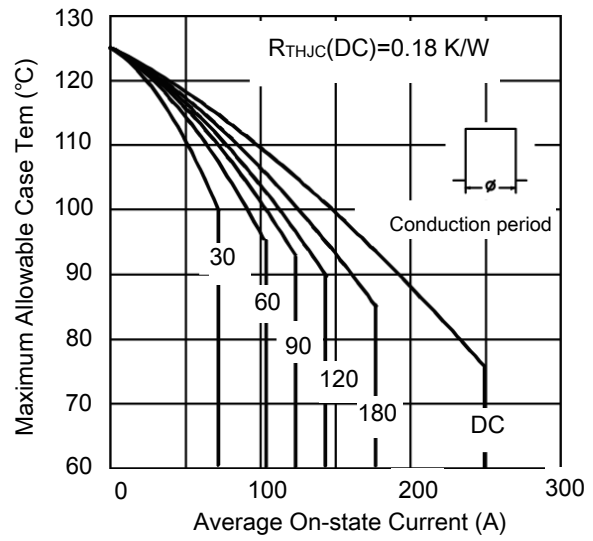

Figure 2. Current Rating Characteristics

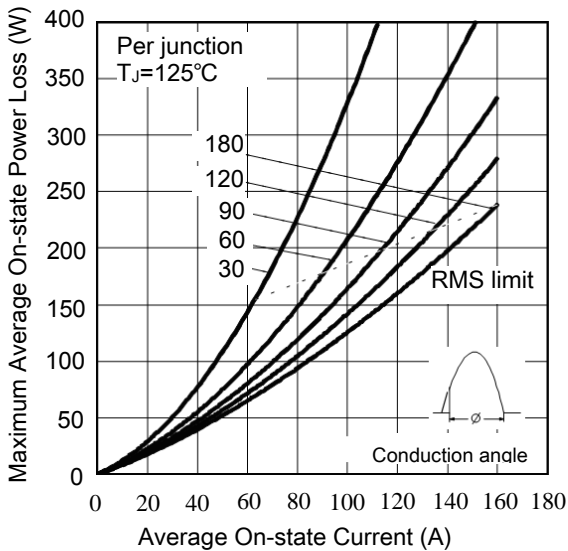

Figure 3. On-state Power Loss Characteristics

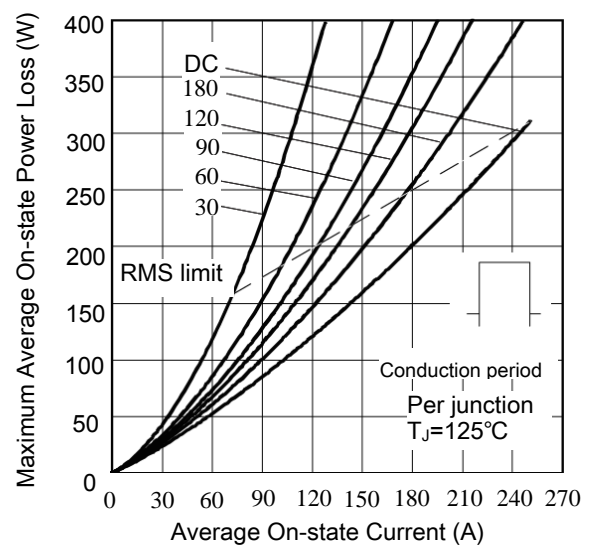

Figure 4. On-state Power Loss Characteristics

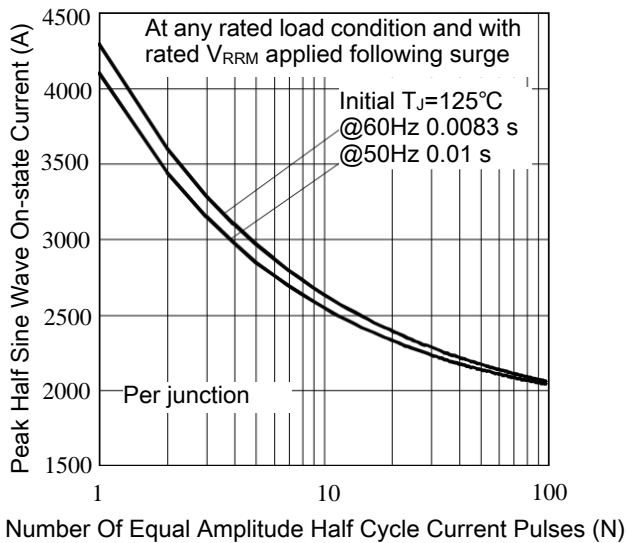

Figure 5. Maximum Non-Repetitive Surge Current

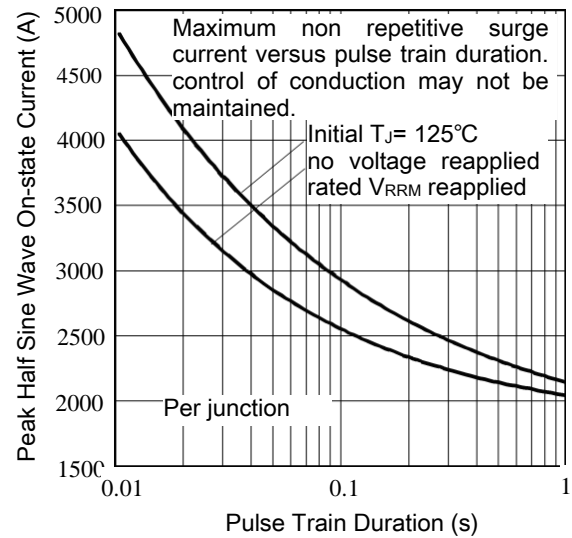

Figure 6. Maximum Non-Repetitive Surge Current

MMK160S160B

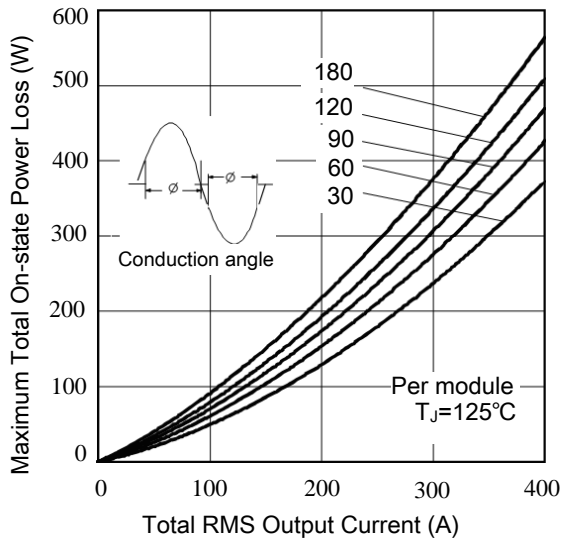

Figure 7. On-State Power Loss Characteristics-1

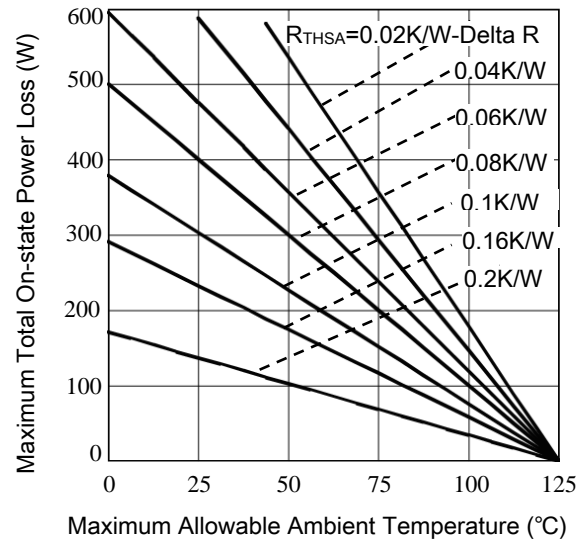

Figure.8 On-State Power Loss Characteristics-2

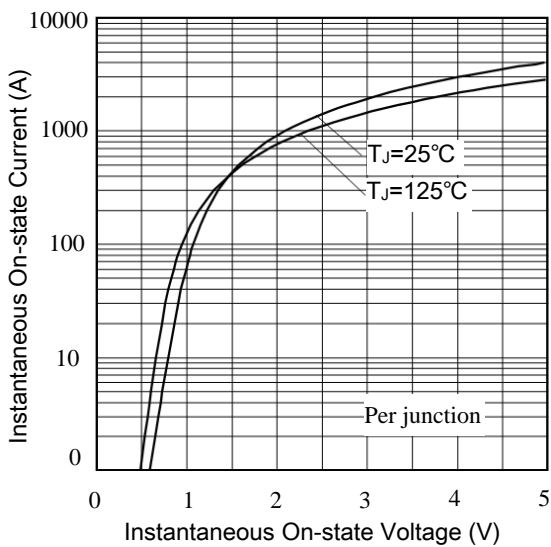

Figure 9. On State Voltage Drop Characteristics

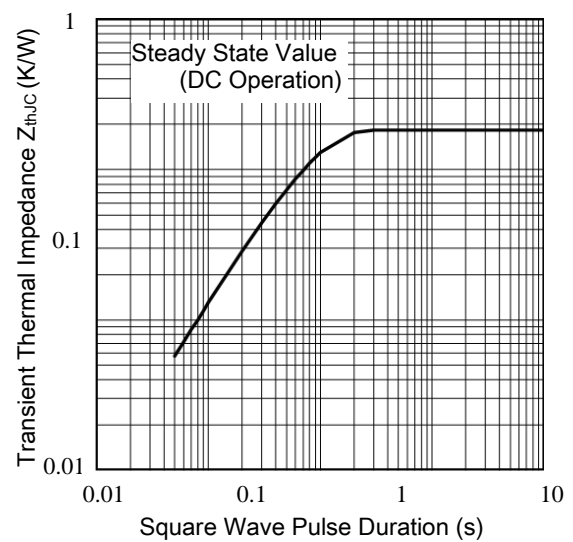

Figure 10. Thermal Impedance Z_{thJC} Characteristics

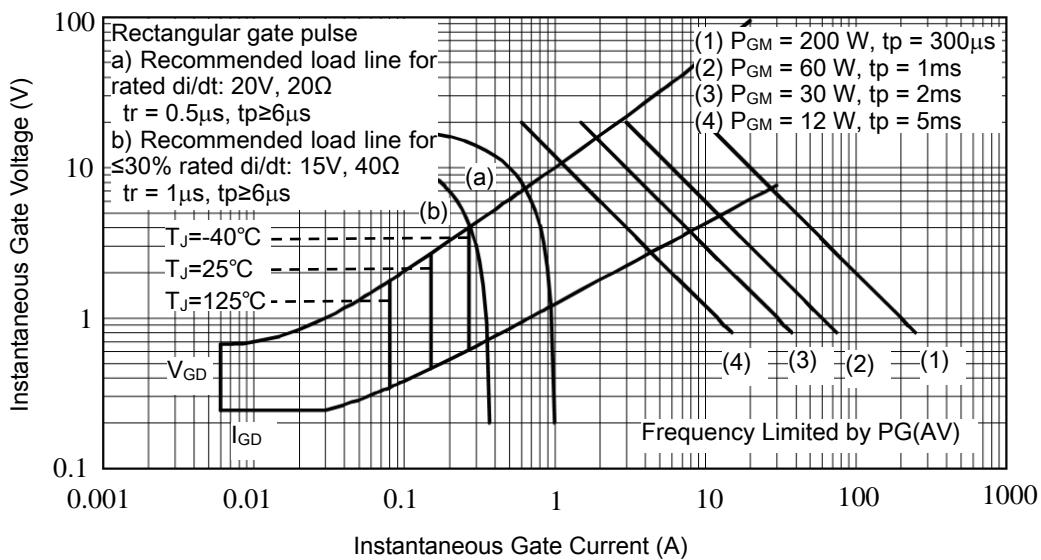

Figure 11. Gate Characteristics

Package Outline (Dimensions in mm)

