

PRODUCT FEATURES

- Electrically Isolated by DBC Ceramic
- High Surge Current Capability
- Low Inductance Package

APPLICATIONS

- DC Motor Control and Drives
- Battery Charges ,Heater controls,Light dimmers
- Static switches

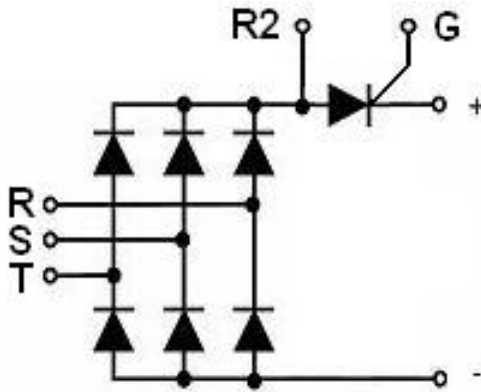

MAXIMUM VOLTAGE RATINGS

$T_C = 25^\circ\text{C}$ unless otherwise specified

Module Type	V_{RRM}/V_{DRM}	V_{RSM}	Unit
MMK150T160UX6J	1600	1700	V

ABSOLUTE MAXIMUM RATINGS (Thyristor)

Symbol	Parameter/Test Conditions		Values	Unit
$I_{T(AV)}$	Average On-State Current	Single phase, half wave, 180°conduction, $T_c = 80^\circ\text{C}$	150	A
$I_{T(RMS)}$	R.M.S. On-State Current		225	
I_{TSM}	Non-Repetitive Surge On-State Current		3600/3800	
I^2t	I^2t (For Fusing)	1/2 cycle, 50/60HZ, peak value, $T_c = 45^\circ\text{C}$	64.8/59.8	KA ² S
T_J	Junction Temperature(Thyristor)		-40 to +125	°C

ABSOLUTE MAXIMUM RATINGS (Diode)

Symbol	Parameter/Test Conditions		Values	Unit
$I_{F(AV)}$	Average Forward Current	Single phase, half wave, 180°conduction, $T_c = 95^\circ\text{C}$	150	A
$I_{F(RMS)}$	R.M.S. Forward Current		225	
I_{FSM}	Non-Repetitive Surge Forward Current		1700/1800	
I^2t	For Fusing	1/2 cycle, 50/60HZ, peak value, $T_c = 45^\circ\text{C}$	14.4/13.4	KA ² S
T_J	Junction Temperature(Diode)		-40 to +150	°C

ELECTRICAL CHARACTERISTICS (Thyristor)

$T_C=25^{\circ}\text{C}$ unless otherwise specified

Symbol	Parameter/Test Conditions		Min.	Typ.	Max.	Unit
I_{DRM}	Maximum Peak Off-State Current	$V_D = V_{DRM}, T_J = 125^{\circ}\text{C}$			25	mA
I_{RRM}	Maximum Peak Reverse Current	$V_R = V_{RRM}, T_J = 125^{\circ}\text{C}$			25	
V_{TM}	Maximum on-state voltage drop	$I_{TM}=150\text{A}, t_d=10\text{ ms, half sine}$			1.18	V
V_{TO}	For power-loss calculations only	$T_J = 125^{\circ}\text{C}$			0.9	V
r_T					2.0	mΩ
V_{GT}	Max. required DC gate voltage to trigger	$V_A=6\text{V}, R_A=1\Omega, T_J = -40^{\circ}\text{C}$			4.0	V
		$V_A=6\text{V}, R_A=1\Omega$		0.8	2.5	
		$V_A=6\text{V}, R_A=1\Omega, T_J = 125^{\circ}\text{C}$			1.7	
I_{GT}	Max. required DC gate current to trigger	$V_A=6\text{V}, R_A=1\Omega, T_J = -40^{\circ}\text{C}$			270	mA
		$V_A=6\text{V}, R_A=1\Omega$		65	150	
		$V_A=6\text{V}, R_A=1\Omega, T_J = 125^{\circ}\text{C}$			80	
V_{GD}	Max. required DC gate voltage not to trigger,	$V_D = V_{DRM}, T_J = 125^{\circ}\text{C}$			0.25	V
I_{GD}	Max. required DC gate current not to trigger,	$V_D = V_{DRM}, T_J = 125^{\circ}\text{C}$			6	mA
I_H	Maximum holding current			200	400	mA
I_L	Maximum latching current			250	500	mA
P_{GM}	Maximum peak gate power				12	W
$P_{G(AV)}$	Maximum average gate power				3.0	
I_{GM}	Maximum peak gate current				3.0	A
$-V_{GM}$	Maximum peak negative gate voltage				10	V
dv/dt	Critical Rate of Rise of Off-State Voltage, $T_J=125^{\circ}\text{C}$, exponential to 67% rated V_{DRM}				1000	V/μs
di/dt	Max. Rate of Rise of Turned-on Current, $T_J = 125^{\circ}\text{C}, I_{TM}=500\text{A}$, rated V_{DRM}				150	A/μs

ELECTRICAL CHARACTERISTICS (Diode)

Symbol	Parameter/Test Conditions		Min.	Typ.	Max.	Unit
I_{RM}	Maximum Reverse Leakage Current	$V_R = V_{RRM}$			0.5	mA
		$V_R = V_{RRM}, T_J = 125^{\circ}\text{C}$			10	
V_F	Forward Voltage Drop	$I_F=150\text{A}$			1.25	V
V_{TO}	For power-loss calculations only , $T_J = 125^{\circ}\text{C}$				0.9	V
r_T					2.2	mΩ

MODULE CHARACTERISTICS

$T_C=25^{\circ}\text{C}$ unless otherwise specified

T_{STG}	Storage Temperature Range			-40 to +125	°C
V_{ISO}	Isolation Breakdown Voltage	AC, 50Hz(R.M.S), t=1minute		3000	V
Torque	to heatsink	Recommended (M6)		3~5	N.m
Torque	to terminal	Recommended (M6)		3~5	N.m
$R_{th(J-C)}$	Junction-to-Case Thermal Resistance(Per Thyristor/Per Diode)			0.18/0.45	K/W
Weight				330	g

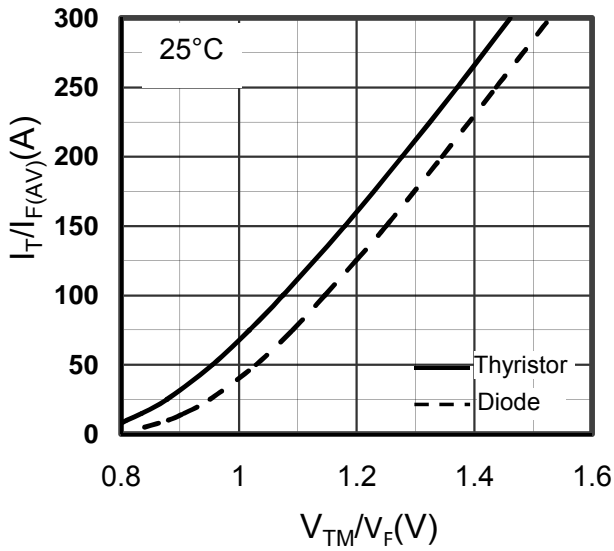

Figure1. Forward Voltage Drop vs Forward Current

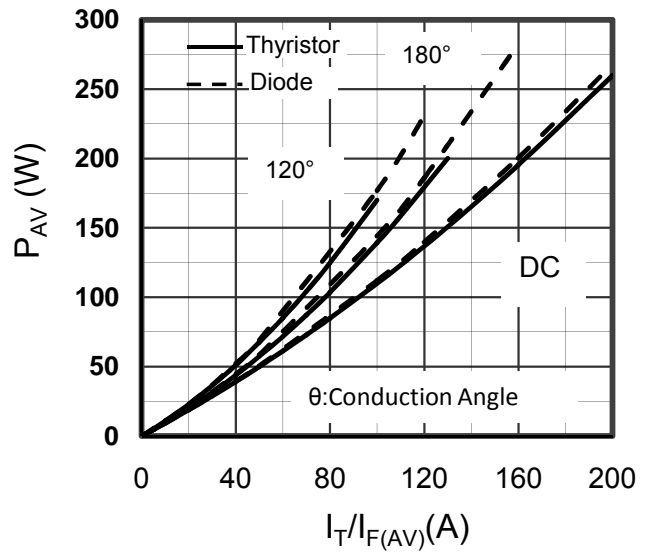

Figure2. Power dissipation vs. $I_T/I_{F(AV)}$

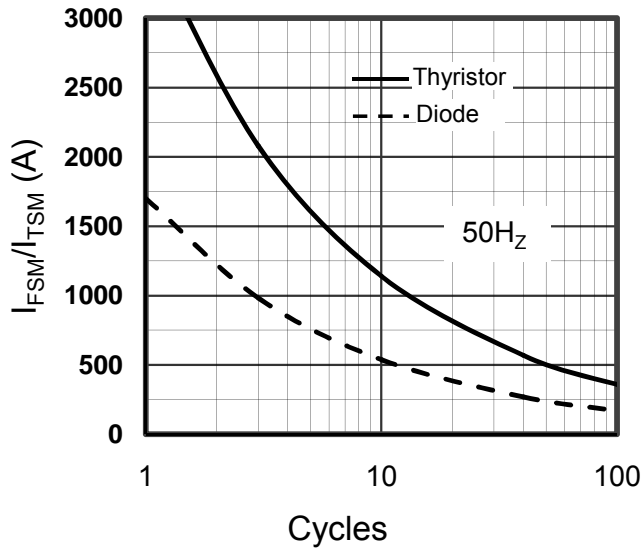

Figure3. Diode and SCR Max Non-Repetitive Surge

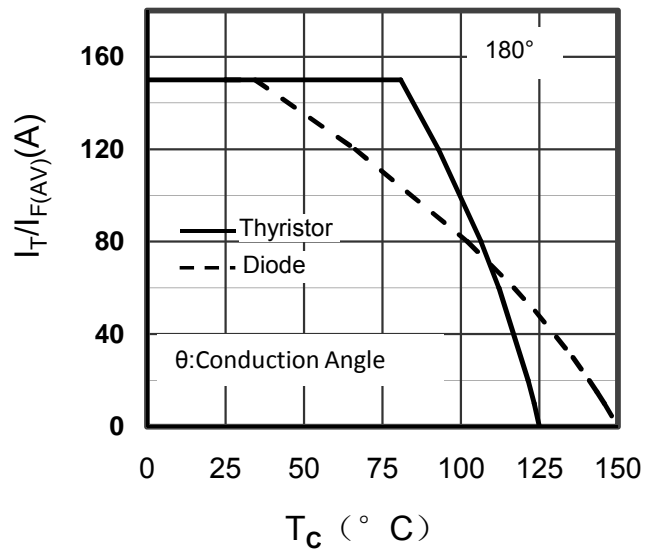

Figure4. Diode $I_{F(AV)}$ and SCR $I_{T(AV)}$ vs. T_C

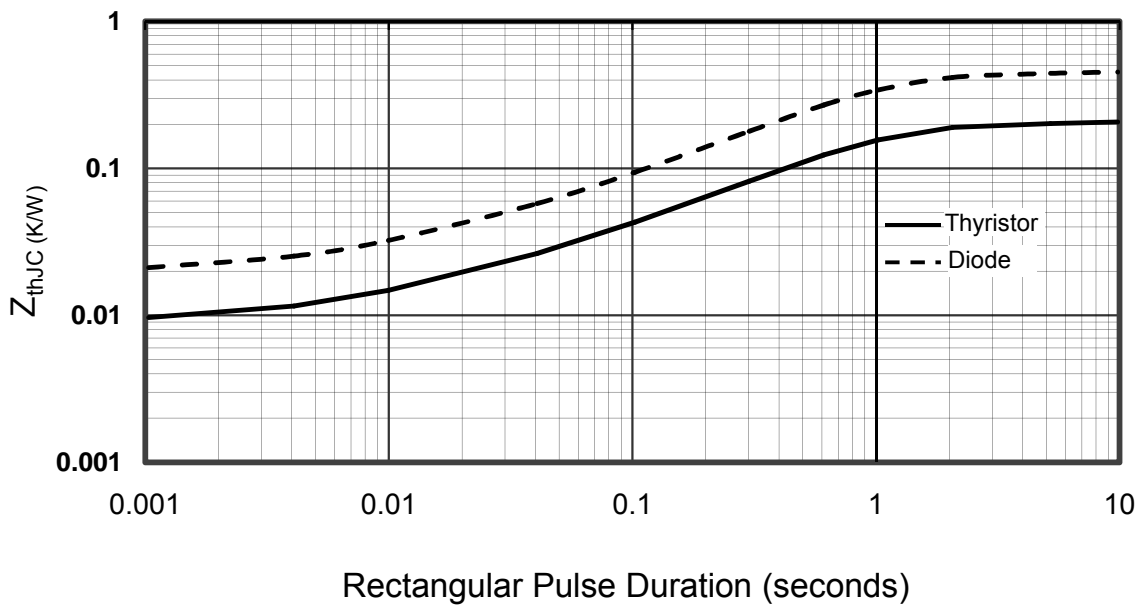

Figure5. Transient Thermal Impedance of Diode and SCR

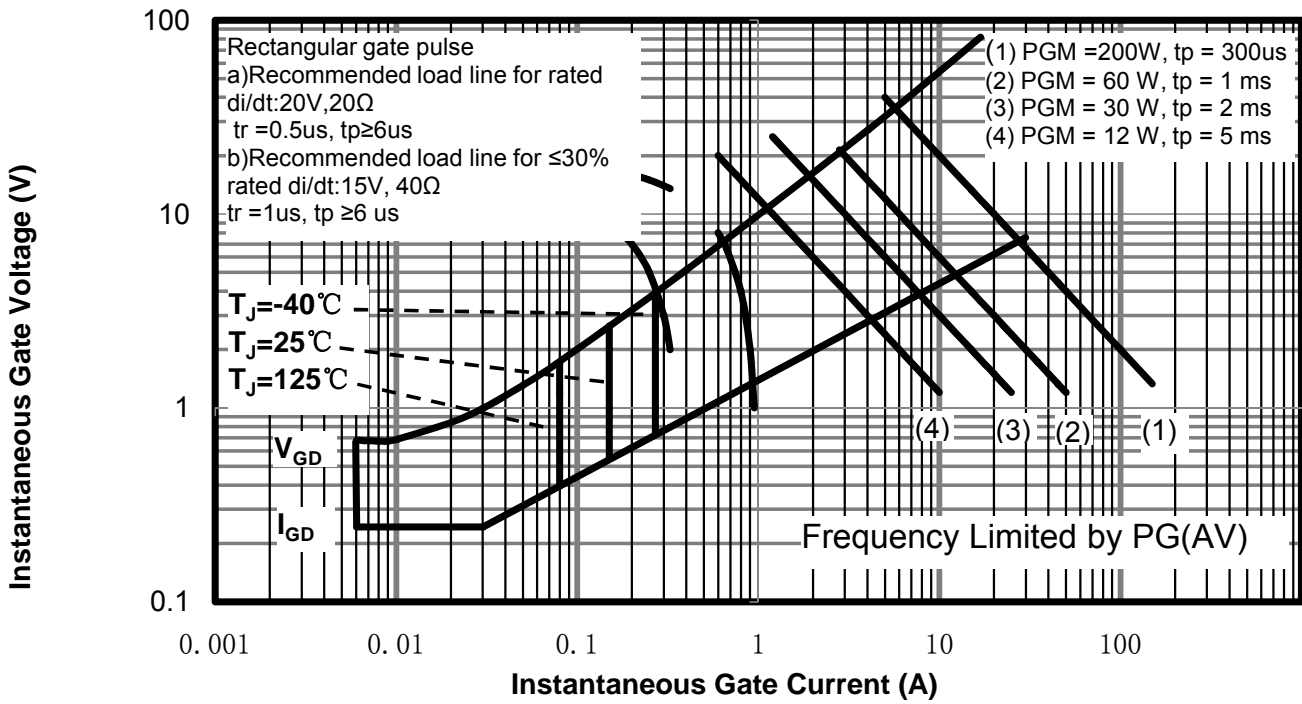
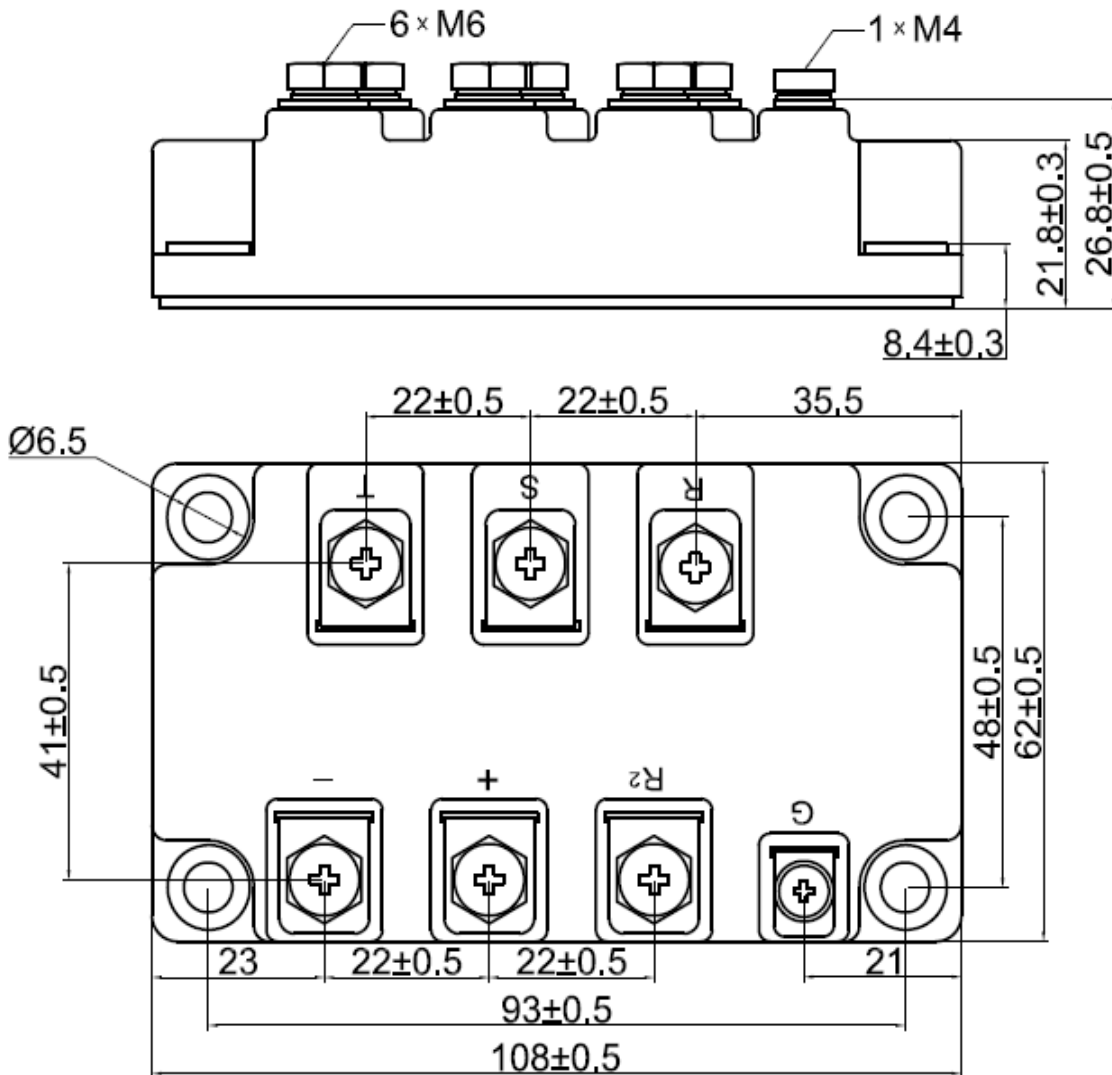

Figure 6. SCR Gate Characteristics



Dimensions in Millimeters
 Figure 7. Package Outline