

## Features

- Isolation voltage 3500 V~
- Industrial Standard Package
- High Surge Capability
- Glass Passivated Chips
- Simple Mounting
- Electrically Isolated by DBC Ceramic



## Applications

- DC Motor Control and Drives
- Battery Charges
- Welders
- Power Converters
- Lighting Control
- Heat and Temperature Control

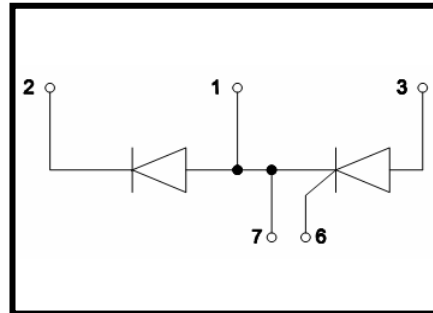

## Advantages

- Space and weight savings
- Improved temperature and power cycling

## ABSOLUTE MAXIMUM RATINGS

 $T_C=25^{\circ}\text{C}$  unless otherwise specified

Symbol	Test Condition	Value	Unit
$V_{RRM}$		1600	V
$I_{T(AV)}$	$T_C=85^{\circ}\text{C}$ , 180° conduction, half sine wave;	130	A
$I_{T(RMS)}$	as AC switch;	300	A
$I_{TSM}$	$T_J=45^{\circ}\text{C}$ , $t=10\text{ms}$ (50Hz), sine, $V_R=0$ ;	3200	A
	$T_J=45^{\circ}\text{C}$ , $t=8.3\text{ms}$ (60Hz), sine, $V_R=0$ ;	3360	
	$T_J=45^{\circ}\text{C}$ , $t=10\text{ms}$ (50Hz), sine, $V_R=V_{RRM}$ ;	2700	
	$T_J=45^{\circ}\text{C}$ , $t=8.3\text{ms}$ (60Hz), sine, $V_R=V_{RRM}$ ;	2800	
$I^2t$	$T_J=45^{\circ}\text{C}$ , $t=10\text{ms}$ (50Hz), sine, $V_R=0$ ;	52	$\text{K A}^2\text{s}$
	$T_J=45^{\circ}\text{C}$ , $t=8.3\text{ms}$ (60Hz), sine, $V_R=0$ ;	57	
	$T_J=45^{\circ}\text{C}$ , $t=10\text{ms}$ (50Hz), sine, $V_R=V_{RRM}$ ;	37	
	$T_J=45^{\circ}\text{C}$ , $t=8.3\text{ms}$ (60Hz), sine, $V_R=V_{RRM}$ ;	39	
$I_{DRM}/I_{RRM}$	$T_J=125^{\circ}\text{C}$ , $V_D=V_R=1600\text{V}$ ;	50	mA
$dV/dt$	$T_J=125^{\circ}\text{C}$ , exponential to 67% rated $V_{DRM}$	1000	V/us
$V_{ISOL}$	50Hz, all terminals shorted, $t=1\text{s}$ , $I_{ISOL}\leq 1\text{mA}$ ;	3500	V~
$T_J$	Max. junction operating temperature range	-40~125	$^{\circ}\text{C}$
$T_{STG}$	Max. storage temperature range	-40~150	$^{\circ}\text{C}$

**ELECTRICAL CHARACTERISTICS**T<sub>C</sub>=25°C unless otherwise specified

Symbol	Test Condition	Min.	Typ.	Max.	Unit
V <sub>TO</sub>	16.7% × π × I <sub>AV</sub> < I < π × I <sub>AV</sub> , T <sub>J</sub> =130°C;			0.86	V
	I > π × I <sub>AV</sub> , T <sub>J</sub> =130°C;			1.05	V
r <sub>t</sub>	16.7% × π × I <sub>AV</sub> < I < π × I <sub>AV</sub> , T <sub>J</sub> =130°C;			2.02	mΩ
	I > π × I <sub>AV</sub> , T <sub>J</sub> =130°C;			1.65	mΩ
I <sub>H</sub>	V <sub>AK</sub> = 6V, initial I <sub>T</sub> =30A;			200	mA
I <sub>L</sub>	Anode supply =6V, resistive load=1Ω, gate pulse =10V, 100us;			400	mA
V <sub>TM</sub>	I <sub>TM</sub> =408A, t <sub>d</sub> =10 ms, half sine;		1.57		V
P <sub>GM</sub>	t <sub>p</sub> ≤5ms, T <sub>J</sub> =125°C;			12	W
P <sub>GM(AV)</sub>	f=50Hz, T <sub>J</sub> =125°C;			3	W
I <sub>GM</sub>	t <sub>p</sub> ≤5ms, T <sub>J</sub> =125°C;			3	A
-V <sub>GT</sub>				10	V
V <sub>GT</sub>	V <sub>A</sub> =6V, R <sub>A</sub> =1Ω, T <sub>J</sub> =-40°C;			4	V
	V <sub>A</sub> =6V, R <sub>A</sub> =1Ω;			2.5	
	V <sub>A</sub> =6V, R <sub>A</sub> =1Ω, T <sub>J</sub> =125°C;			1.7	
I <sub>GT</sub>	V <sub>A</sub> =6V, R <sub>A</sub> =1Ω, T <sub>J</sub> =-40°C;			270	A
	V <sub>A</sub> =6V, R <sub>A</sub> =1Ω;			150	
	V <sub>A</sub> =6V, R <sub>A</sub> =1Ω, T <sub>J</sub> =125°C;			80	
V <sub>GD</sub>	V <sub>AK</sub> =V <sub>DRM</sub> , T <sub>J</sub> =125°C			0.3	V
I <sub>GD</sub>				10	mA
di/dt	I <sub>TM</sub> =400A, rated V <sub>DRM</sub> , T <sub>J</sub> =125°C			300	A/us

**THERMAL AND MECHANICAL CHARACTERISTICS**T<sub>C</sub>=25°C unless otherwise specified

Symbol	Test Condition	value	Unit
R <sub>thjc</sub>	DC operation, per junction;	0.20	K/W
R <sub>THCS</sub>	Mounting surface smooth,flat and greased, per junction;	0.1	K/W
Md	Mounting torque(M6)	4 to 6	N·m
	Terminal connection torque(M6)		
Weight	Typical value	156	g

Characteristic curves

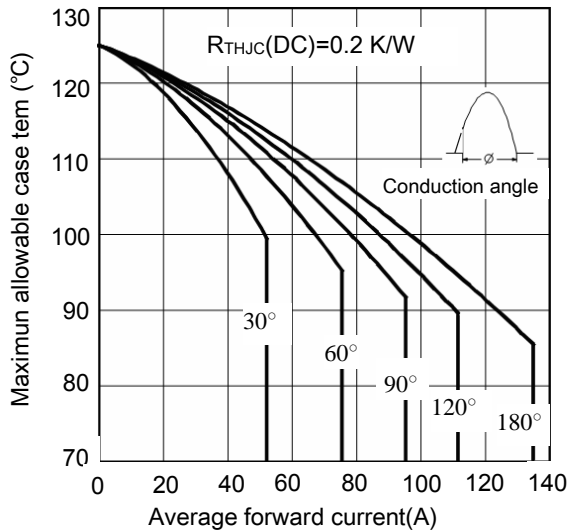

Figure 1. current rating characteristics

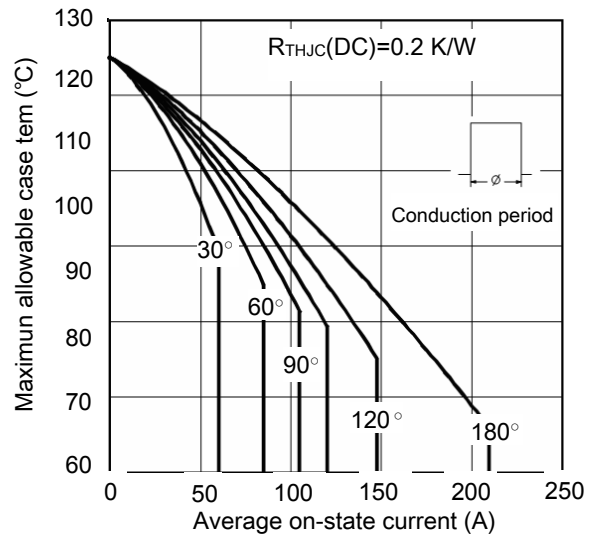

Figure 2. current rating characteristics

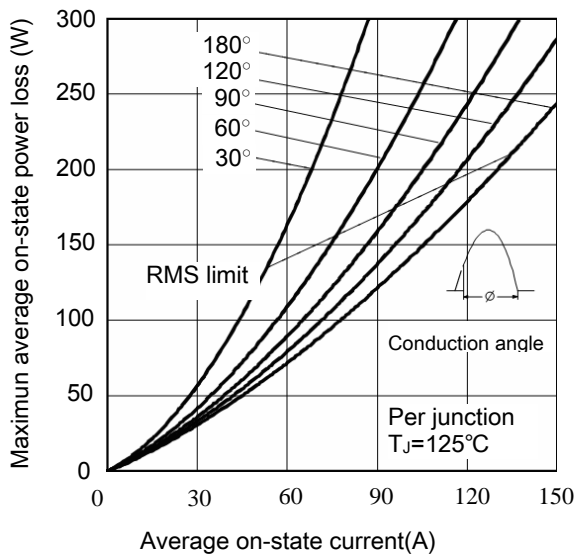

Figure 3. on-state power loss characteristics

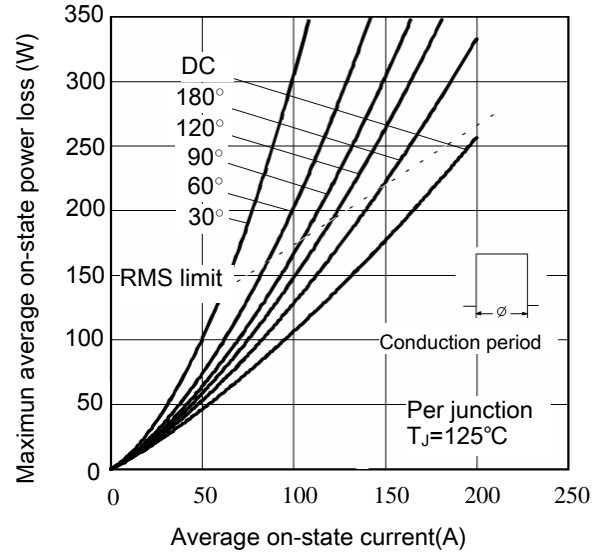

Figure 4. on-state power loss characteristics

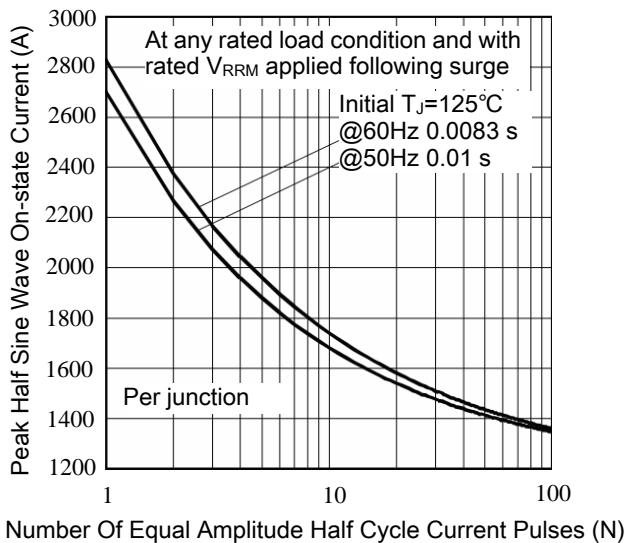

Figure 5. Maximum Non-Repetitive Surge Current

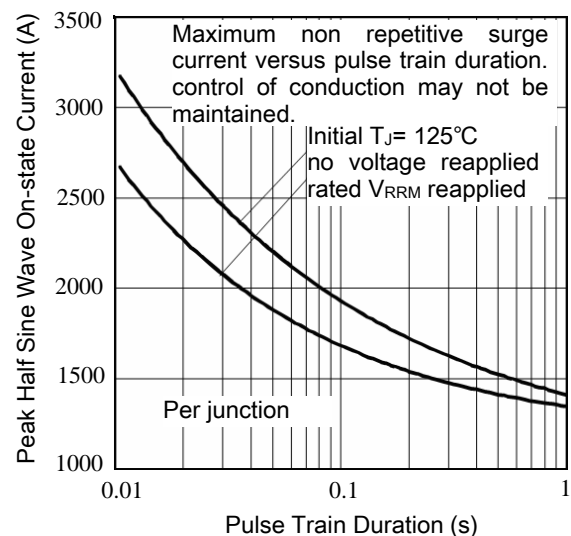

Figure 6. Maximum Non-Repetitive Surge Current

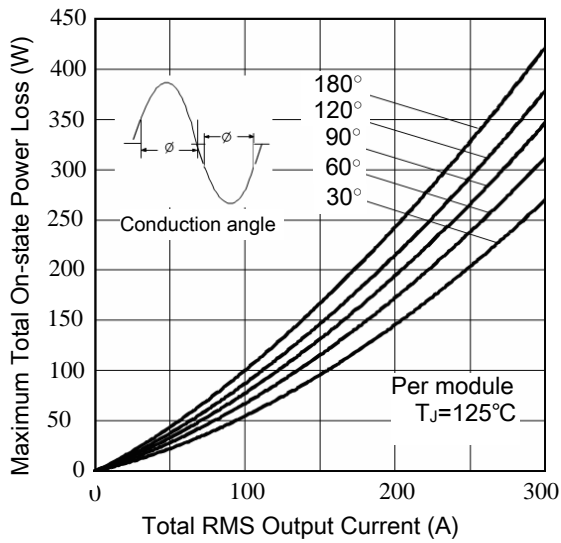

Figure 7. On-State Power Loss Characteristics-1

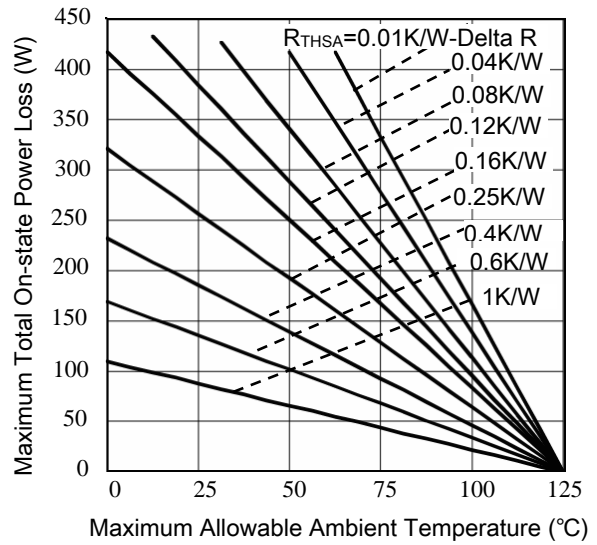

Figure 8 On-State Power Loss Characteristics-2

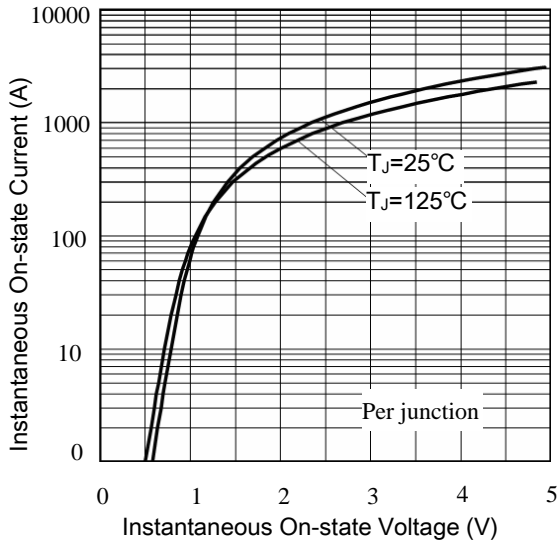

Figure.9 On State Voltage Drop Characteristics

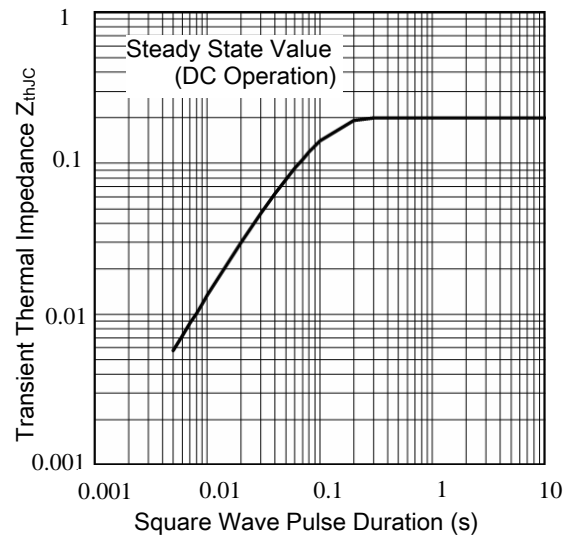

Figure.10 Thermal Impedance ZthJC Characteristics

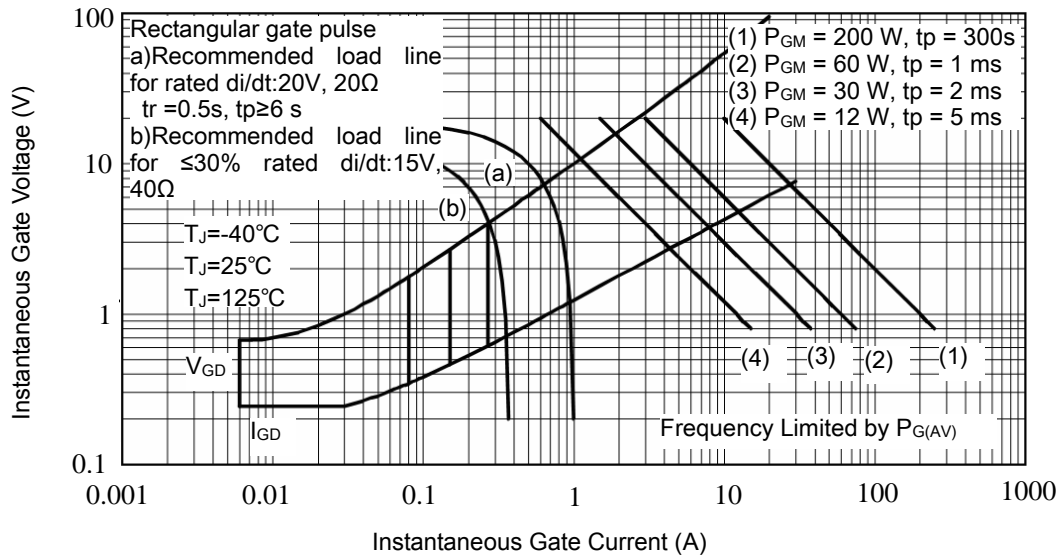

Figure.11 Gate Characteristics

Package Outline (Dimensions in mm)

