

Features

- Isolation voltage 3500 V~
- Industrial Standard Package
- High Surge Capability
- Glass Passivated Chips
- Simple Mounting
- Electrically Isolated by DBC Ceramic



Applications

- DC Motor Control and Drives
- Battery Charges
- Welders
- Power Converters
- Lighting Control
- Heat and Temperature Control

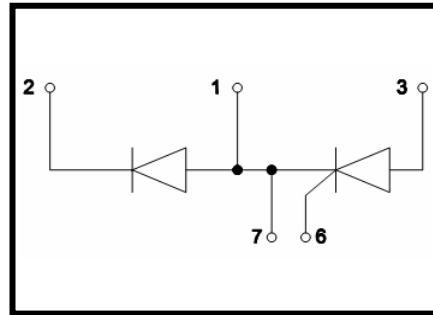

Advantages

- Space and weight savings
- Improved temperature and power cycling

ABSOLUTE MAXIMUM RATINGS

$T_C=25^\circ\text{C}$ unless otherwise specified

Symbol	Test Condition	Value	Unit
V_{RRM}		1600	V
$I_{T(AV)}$	$T_C=85^\circ\text{C}$, 180° conduction, half sine wave;	110	A
$I_{T(RMS)}$	as AC switch;	235	A
I_{TSM}	$T_J=45^\circ\text{C}$, $t=10\text{ms}$ (50Hz), sine, $V_R=0$;	1785	A
	$T_J=45^\circ\text{C}$, $t=8.3\text{ms}$ (60Hz), sine, $V_R=0$;	1870	
	$T_J=45^\circ\text{C}$, $t=10\text{ms}$ (50Hz), sine, $V_R=V_{RRM}$;	1500	
	$T_J=45^\circ\text{C}$, $t=8.3\text{ms}$ (60Hz), sine, $V_R=V_{RRM}$;	1570	
I^2t	$T_J=45^\circ\text{C}$, $t=10\text{ms}$ (50Hz), sine, $V_R=0$;	16	K A ² s
	$T_J=45^\circ\text{C}$, $t=8.3\text{ms}$ (60Hz), sine, $V_R=0$;	17.5	
	$T_J=45^\circ\text{C}$, $t=10\text{ms}$ (50Hz), sine, $V_R=V_{RRM}$;	11.2	
	$T_J=45^\circ\text{C}$, $t=8.3\text{ms}$ (60Hz), sine, $V_R=V_{RRM}$;	12.3	
I_{DRM}/I_{RRM}	$T_J=130^\circ\text{C}$, $V_D=V_R=1600\text{V}$, gate open circuit;	20	mA
dV/dt	$T_J=130^\circ\text{C}$, exponential to 67% rated V_{DRM}	500	V/us
V_{ISOL}	50Hz, all terminals shorted, $t=1\text{s}$, $I_{ISOL}\leq 1\text{mA}$;	3500	V~
T_J	Max. junction operating temperature range	-40~130	°C
T_{STG}	Max. storage temperature range	-40~150	°C

ELECTRICAL CHARACTERISTICS $T_C=25^\circ\text{C}$ unless otherwise specified

Symbol	Test Condition	Min.	Typ.	Max.	Unit
V_{TO}	$16.7\% \times p \times I_{AV} < I < p \times I_{AV}, T_J = 130^\circ\text{C};$			0.80	V
	$I > p \times I_{AV}, T_J = 130^\circ\text{C};$			0.85	V
r_t	$16.7\% \times p \times I_{AV} < I < p \times I_{AV}, T_J = 130^\circ\text{C};$			2.37	m Ω
	$I > p \times I_{AV}, T_J = 130^\circ\text{C};$			2.25	m Ω
I_H	$V_{AK} = 6\text{V}$, resistive load;			250	mA
I_L	Anode supply =6V, resistive load=1 Ω , gate pulse =10V, 100us;			400	mA
V_{TM}	$I_{TM} = 345\text{A}$, $t_d = 10\text{ms}$, half sine		1.64		V
P_{GM}	$t_p \leq 5\text{ms}$, $T_J = 125^\circ\text{C};$			12	W
$P_{GM(AV)}$	$f = 50\text{Hz}$, $T_J = 125^\circ\text{C};$			3	W
I_{GM}	$t_p \leq 5\text{ms}$, $T_J = 125^\circ\text{C};$			3	A
$-V_{GT}$				10	V
V_{GT}	$V_A = 6\text{V}$, $R_A = 1\Omega$, $T_J = -40^\circ\text{C};$			4	V
	$V_A = 6\text{V}$, $R_A = 1\Omega;$			2.5	
	$V_A = 6\text{V}$, $R_A = 1\Omega$, $T_J = 125^\circ\text{C};$			1.7	
I_{GT}	$V_A = 6\text{V}$, $R_A = 1\Omega$, $T_J = -40^\circ\text{C};$			270	mA
	$V_A = 6\text{V}$, $R_A = 1\Omega;$			150	
	$V_A = 6\text{V}$, $R_A = 1\Omega$, $T_J = 125^\circ\text{C};$			80	
V_{GD}	$V_{AK} = V_{DRM}$, $T_J = 125^\circ\text{C}$			0.25	V
I_{GD}				6	mA
di/dt	$T_J = 25^\circ\text{C}$, $V_D = 0.67V_{DRM}$, $I_{TM} = 345\text{A}$, $I_g = 500\text{mA}$, $t_r < 0.5\ \mu\text{s}$, $t_p > 6\ \mu\text{s}$			150	A/us

THERMAL AND MECHANICAL CHARACTERISTICS $T_C=25^\circ\text{C}$ unless otherwise specified

Symbol	Test Condition	value	Unit
R_{thjc}	DC operation, per junction;	0.30	K/W
R_{THCS}	Mounting surface smooth, flat and greased, per junction	0.1	K/W
Md	Mounting torque(M5)	3 to 5	N·m
	Terminal connection torque(M5)		
Weight	Typical value	105	g

Characteristic curves

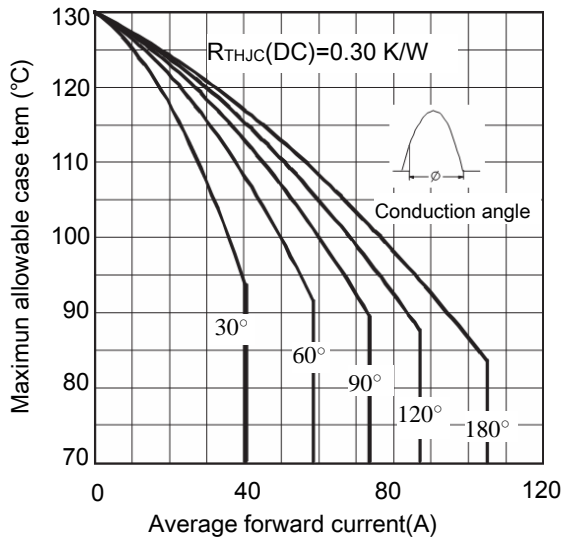

Figure 1. current rating characteristics

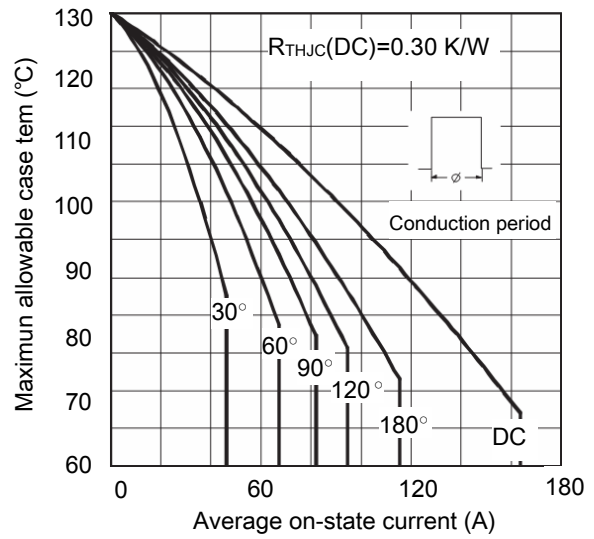

Figure 2. current rating characteristics

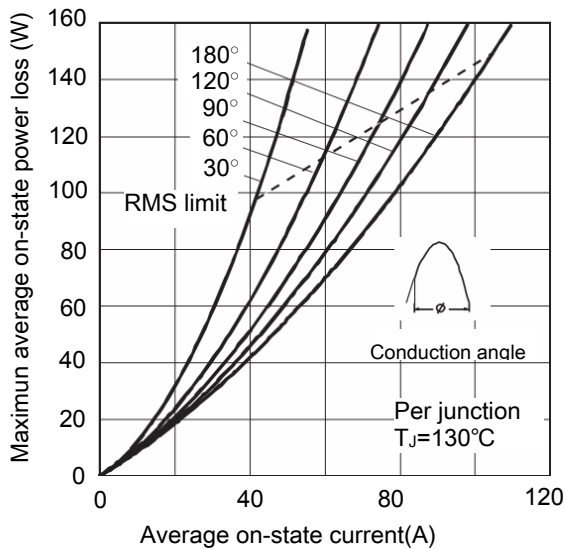

Figure 3. on-state power loss characteristics

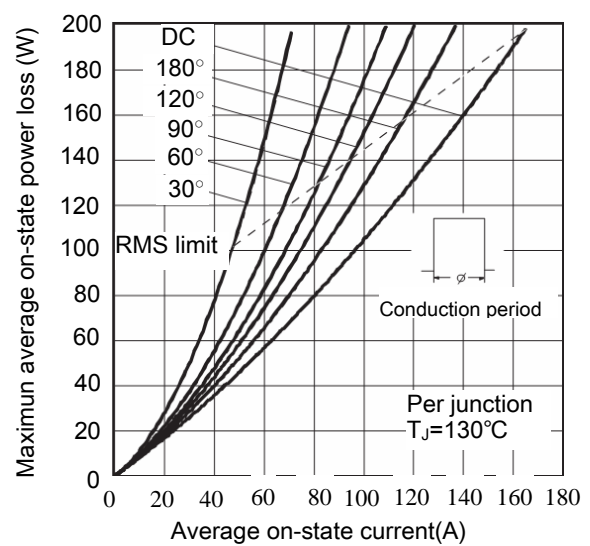

Figure 4. on-state power loss characteristics

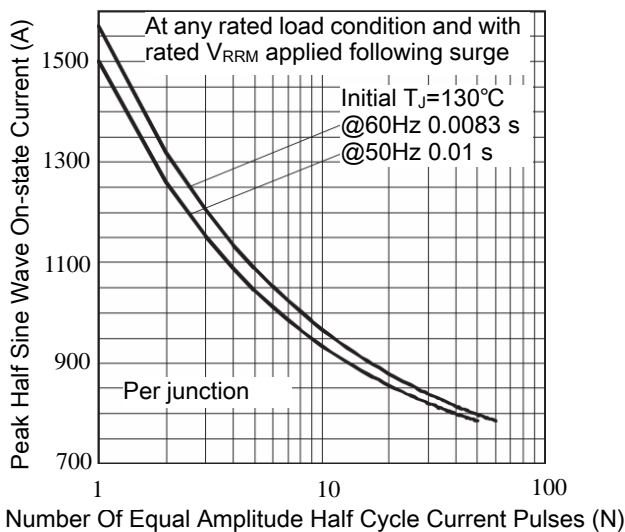

Figure 5. Maximum Non-Repetitive Surge Current

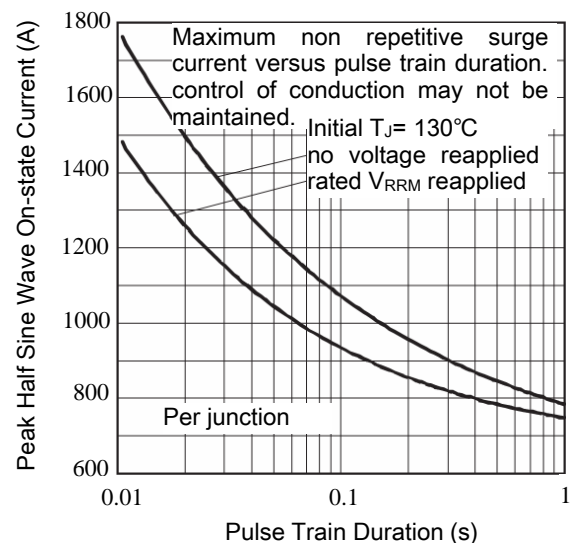

Figure 6. Maximum Non-Repetitive Surge Current

MMK110A160UK

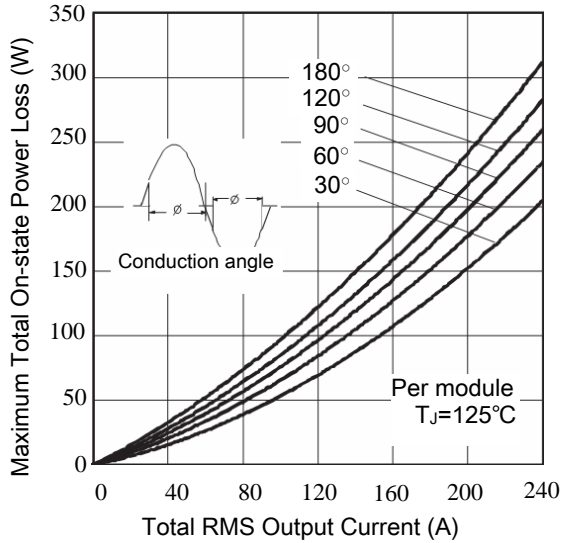

Figure 7. On-State Power Loss Characteristics-1

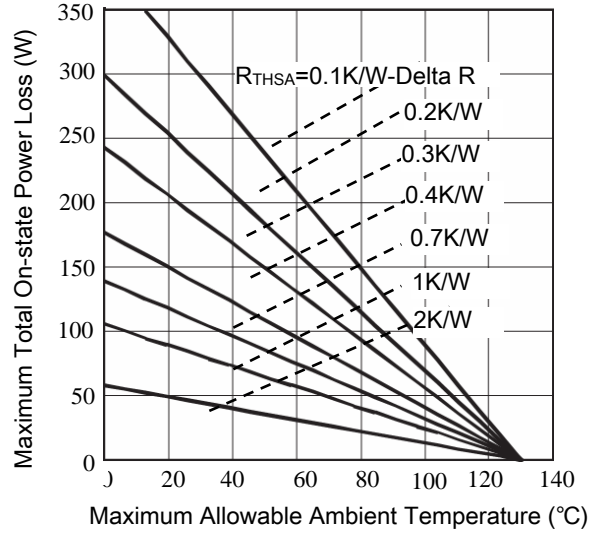

Figure.8 On-State Power Loss Characteristics-2

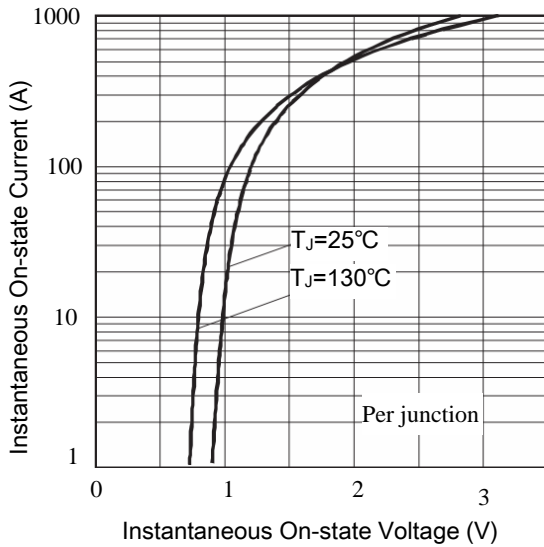

Figure.9 On State Voltage Drop Characteristics

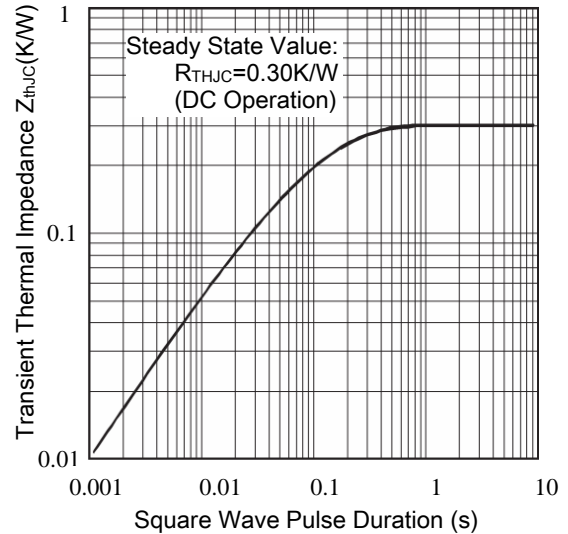

Figure.10 Thermal Impedance ZthJC Characteristics

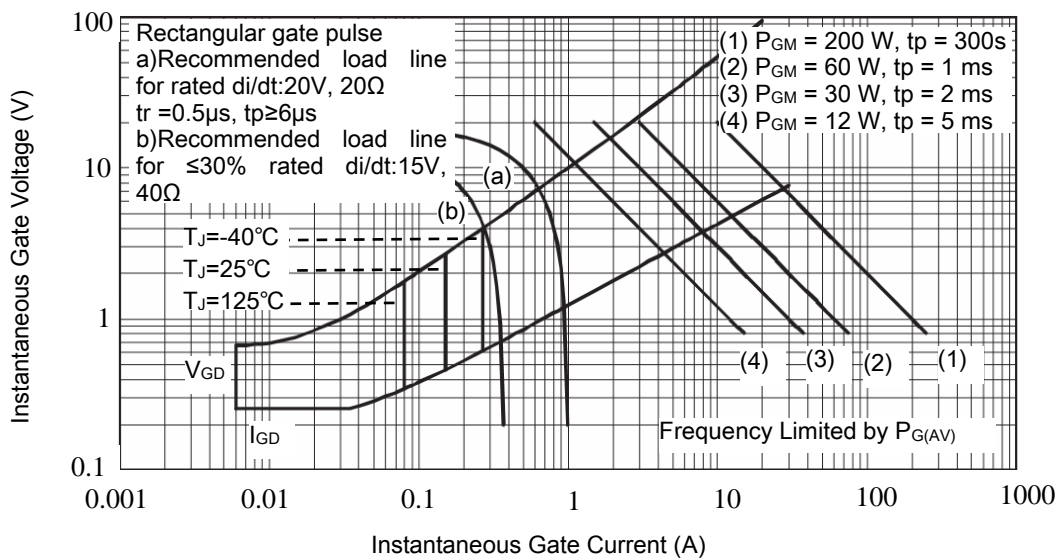

Figure.11 Gate Characteristics

Package Outline (Dimensions in mm)

