

PRODUCT FEATURES

- Electrically Isolated by DBC Ceramic
- High Surge Current Capability
- Low Inductance Package

APPLICATIONS

- DC Motor Control and Drives
- Battery Charges ,Heater controls,Light dimmers
- Static switches

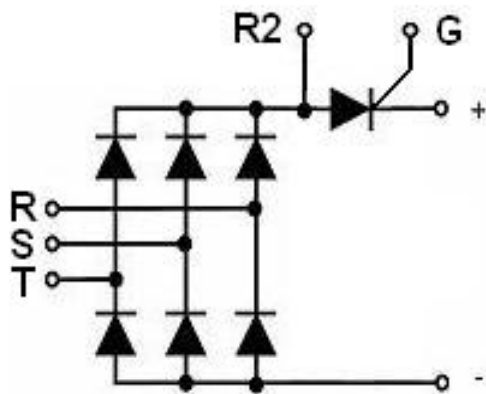

MAXIMUM VOLTAGE RATINGS

$T_C = 25^\circ\text{C}$ unless otherwise specified

Module Type	V_{RRM}/V_{DRM}	V_{RSM}	Unit
MMK100T160UX6J	1600	1700	V

ABSOLUTE MAXIMUM RATINGS (Thyristor)

Symbol	Parameter/Test Conditions		Values	Unit
$I_{T(AV)}$	Average On-State Current	Single phase, half wave, 180°conduction, $T_c = 80^\circ\text{C}$	100	A
$I_{T(RMS)}$	R.M.S. On-State Current		150	
I_{TSM}	Non-Repetitive Surge On-State Current		2500/2700	
I^2t	I^2t (For Fusing)	1/2 cycle, 50/60HZ, peak value, $T_c = 45^\circ\text{C}$	31.2/30.2	KA ² S
T_J	Junction Temperature(Thyristor)		-40 to +125	°C

ABSOLUTE MAXIMUM RATINGS (Diode)

Symbol	Parameter/Test Conditions		Values	Unit
$I_{F(AV)}$	Average Forward Current	Single phase, half wave, 180°conduction, $T_c = 95^\circ\text{C}$	100	A
$I_{F(RMS)}$	R.M.S. Forward Current		150	
I_{FSM}	Non-Repetitive Surge Forward Current		1250/1350	
I^2t	For Fusing	1/2 cycle, 50/60HZ, peak value, $T_c = 45^\circ\text{C}$	7.8/7.5	KA ² S
T_J	Junction Temperature(Diode)		-40 to +150	°C

ELECTRICAL CHARACTERISTICS (Thyristor)

 $T_C=25^{\circ}\text{C}$ unless otherwise specified

Symbol	Parameter/Test Conditions		Min.	Typ.	Max.	Unit
I_{DRM}	Maximum Peak Off-State Current	$V_D = V_{\text{DRM}}, T_J = 125^{\circ}\text{C}$			25	mA
I_{RRM}	Maximum Peak Reverse Current	$V_R = V_{\text{RRM}}, T_J = 125^{\circ}\text{C}$			25	
V_{TM}	Maximum on-state voltage drop	$I_{\text{TM}}=100\text{A}, t_d=10\text{ ms, half sine}$			1.15	V
V_{TO}	For power-loss calculations only	$T_J = 125^{\circ}\text{C}$			0.9	V
r_T					2.5	m Ω
V_{GT}	Max. required DC gate voltage to trigger	$V_A=6\text{V}, R_A=1\Omega, T_J = -40^{\circ}\text{C}$			4.0	V
		$V_A=6\text{V}, R_A=1\Omega$		0.8	2.5	
		$V_A=6\text{V}, R_A=1\Omega, T_J = 125^{\circ}\text{C}$			1.7	
I_{GT}	Max. required DC gate current to trigger	$V_A=6\text{V}, R_A=1\Omega, T_J = -40^{\circ}\text{C}$			270	mA
		$V_A=6\text{V}, R_A=1\Omega$		65	150	
		$V_A=6\text{V}, R_A=1\Omega, T_J = 125^{\circ}\text{C}$			80	
V_{GD}	Max. required DC gate voltage not to trigger,	$V_D = V_{\text{DRM}}, T_J = 125^{\circ}\text{C}$			0.25	V
I_{GD}	Max. required DC gate current not to trigger,	$V_D = V_{\text{DRM}}, T_J = 125^{\circ}\text{C}$			6	mA
I_{H}	Maximum holding current			200	400	mA
I_{L}	Maximum latching current			250	500	mA
P_{GM}	Maximum peak gate power				12	W
$P_{\text{G(AV)}}$	Maximum average gate power				3.0	
I_{GM}	Maximum peak gate current				3.0	A
$-V_{\text{GM}}$	Maximum peak negative gate voltage				10	V
dv/dt	Critical Rate of Rise of Off-State Voltage, $T_J=125^{\circ}\text{C}$, exponential to 67% rated V_{DRM}				1000	V/ μs
di/dt	Max. Rate of Rise of Turned-on Current, $T_J = 125^{\circ}\text{C}, I_{\text{TM}}=500\text{A}$, rated V_{DRM}				150	A/ μs

ELECTRICAL CHARACTERISTICS (Diode)

Symbol	Parameter/Test Conditions		Min.	Typ.	Max.	Unit
I_{RM}	Maximum Reverse Leakage Current	$V_R = V_{\text{RRM}}$			0.5	mA
		$V_R = V_{\text{RRM}}, T_J = 125^{\circ}\text{C}$			10	
V_{F}	Forward Voltage Drop	$I_{\text{F}}=100\text{A}$			1.15	V
V_{TO}	For power-loss calculations only, $T_J = 125^{\circ}\text{C}$				0.9	V
r_T					2.5	m Ω

MODULE CHARACTERISTICS

 $T_C=25^{\circ}\text{C}$ unless otherwise specified

T_{STG}	Storage Temperature Range		-40 to +125	$^{\circ}\text{C}$
V_{ISO}	Isolation Breakdown Voltage	AC, 50Hz(R.M.S), $t=1\text{ minute}$	3000	V
Torque	to heatsink	Recommended (M6)	3~5	N.m
Torque	to terminal	Recommended (M6)	3~5	N.m
$R_{\text{th(J-C)}}$	Junction-to-Case Thermal Resistance(Per Thyristor/Per Diode)		0.2/0.55	K/W
Weight			330	g

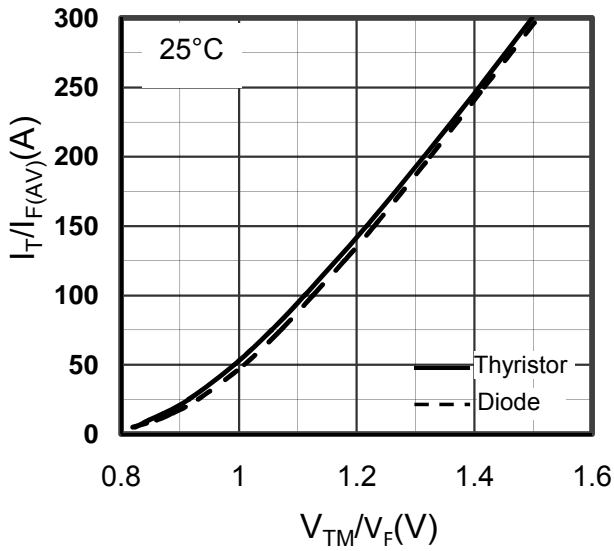

Figure1. Forward Voltage Drop vs Forward Current

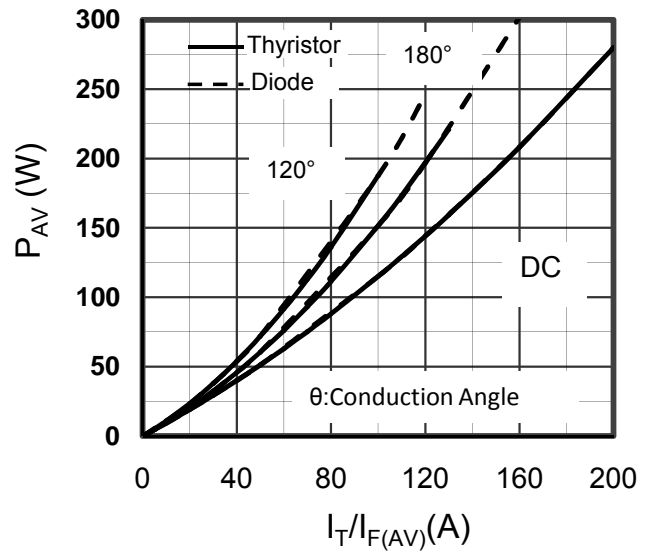

Figure2. Power dissipation vs. $I_T/I_{F(AV)}$

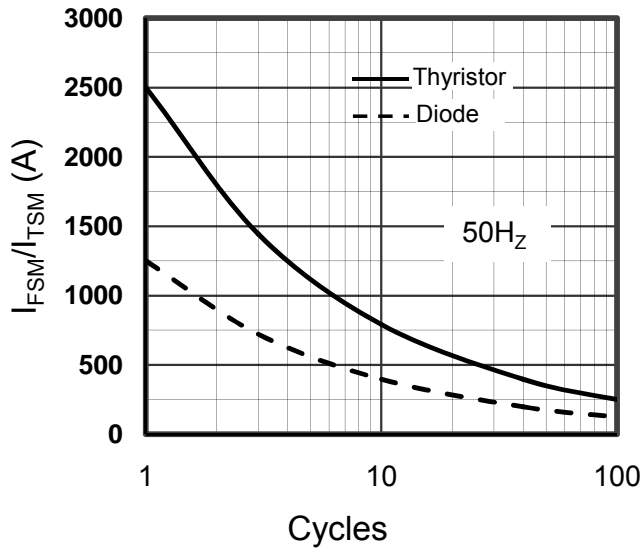

Figure3. Diode and SCR Max Non-Repetitive Surge

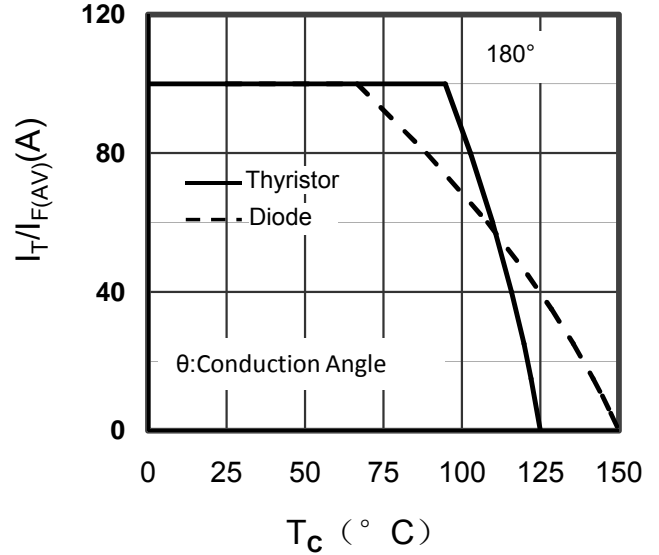

Figure4. Diode $I_{F(AV)}$ and SCR $I_{T(AV)}$ vs. T_C

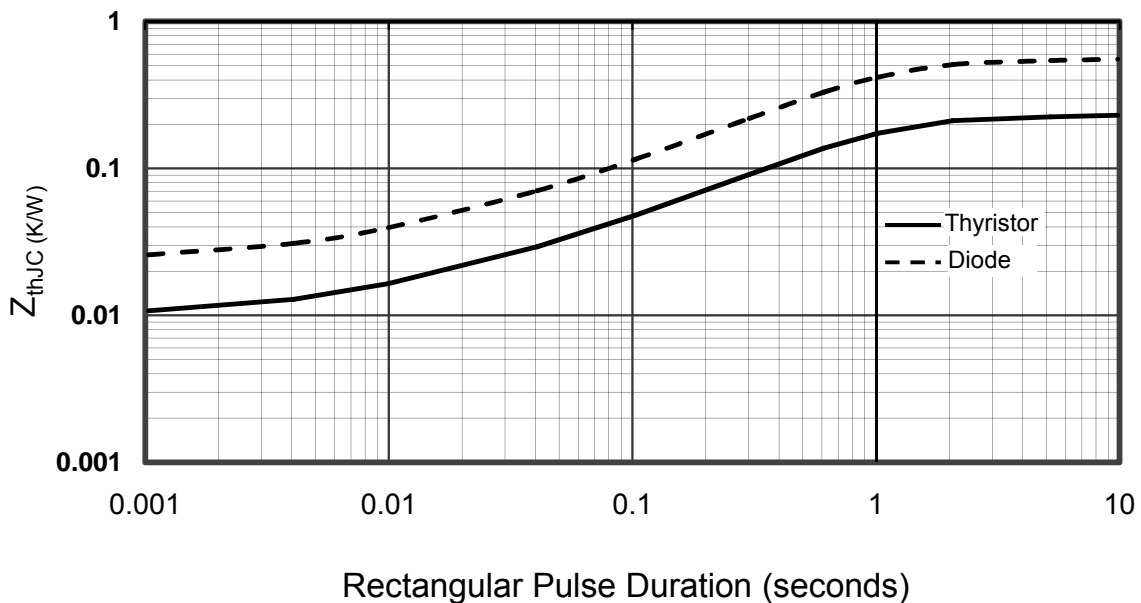

Figure5. Transient Thermal Impedance of Diode and SCR

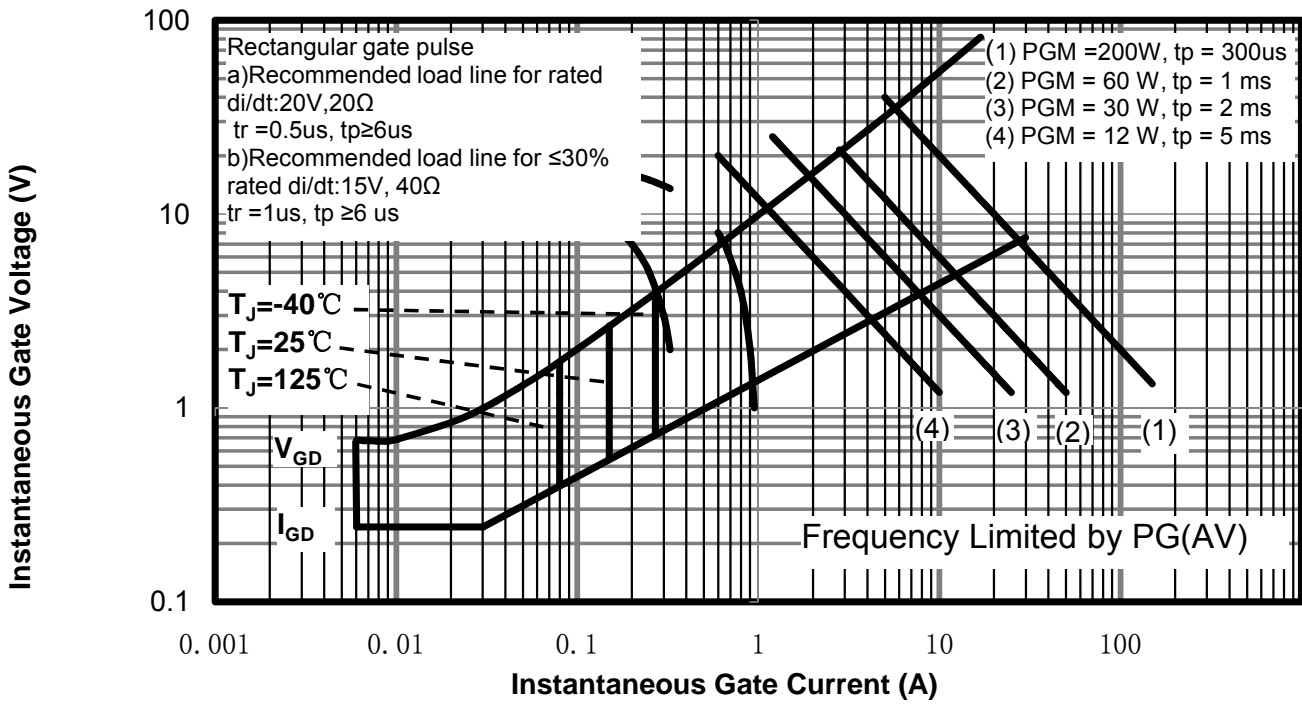
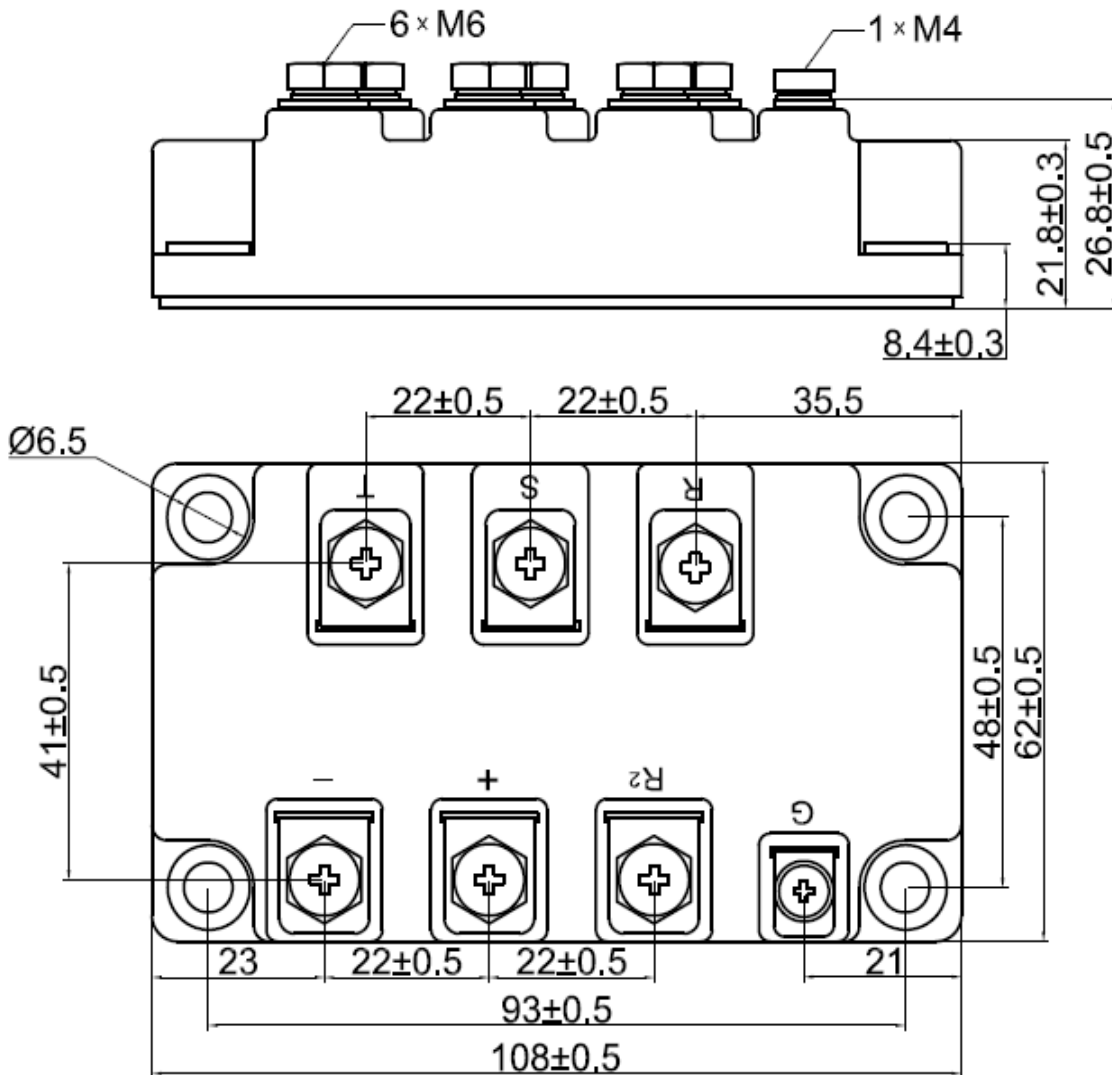

Figure 6. SCR Gate Characteristics



Dimensions in Millimeters
 Figure 7. Package Outline