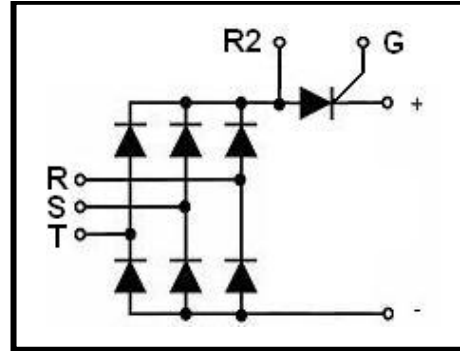

Features

- Isolated Module Package
- Isolation voltage 3000 V
- Three Phase Bridge and a Thyristor

Applications

- Current Stabilized Power Supply
- Switching Power Supply
- Inverter For AC or DC Motor Control

■ Diode
ABSOLUTE MAXIMUM RATINGS
 $T_C=25^{\circ}\text{C}$ unless otherwise specified

Symbol	Parameter	Test Conditions	Max.	Unit
V_{RRM}	Repetitive Reverse Voltage		1600	V
$I_{D(AV)}$	Average Forward Current	$T_C=90^{\circ}\text{C}$, module	100	A
I_{FSM}	Non-Repetitive Surge Forward Current	$T_J=45^{\circ}\text{C}$, $t=10\text{ms}$, 50Hz, Sine	1250	A
		$T_J=45^{\circ}\text{C}$, $t=8.3\text{ms}$, 60Hz, Sine	1350	A
I^2t	I^2t (For Fusing)	$T_J=45^{\circ}\text{C}$, $t=10\text{ms}$, 50Hz, Sine	7.8	kA^2s
		$T_J=45^{\circ}\text{C}$, $t=8.3\text{ms}$, 60Hz, Sine	7.5	kA^2s
T_J	Junction Temperature		-40 to +150	$^{\circ}\text{C}$
T_{STG}	Storage Temperature Range		-40 to +125	$^{\circ}\text{C}$
V_{isol}	Insulation Test Voltage	AC, 50Hz, $t=1\text{min}$	3000	V
Weight			332	g

ELECTRICAL AND THERMAL CHARACTERISTICS
 $T_C=25^{\circ}\text{C}$ unless otherwise specified

Symbol	Parameter	Test Conditions	Min.	Typ.	Max.	Unit
I_{RM}	Reverse Leakage Current	$V_R=1600\text{V}$	--	--	500	μA
		$V_R=1600\text{V}$, $T_J=125^{\circ}\text{C}$	--	--	5	mA
V_F	Forward Voltage	$I_F=100\text{A}$	--	1.15	--	V
		$I_F=100\text{A}$, $T_J=125^{\circ}\text{C}$	--	1.1	--	V
$R_{\theta JC}$	Thermal Resistance Junction-to-Case	per diode	--	--	0.84	$^{\circ}\text{C}/\text{W}$
		per module	--	--	0.14	$^{\circ}\text{C}/\text{W}$
$R_{\theta CS}$	Thermal Resistance Case -to-Sink	per diode	--	--	0.39	$^{\circ}\text{C}/\text{W}$
		per module	--	--	0.065	$^{\circ}\text{C}/\text{W}$

MacMic Science & Technology Co., Ltd.

Add: #18, Hua Shan Zhong Lu, New District, Changzhou City, Jiangsu Province, P. R. of China

 Tel.: +86-519-85163708 Fax: +86-519-85162291 Post Code: 213022 Website: www.macmicst.com

■ Thyristor

ABSOLUTE MAXIMUM RATINGS

$T_C=25^{\circ}\text{C}$ unless otherwise specified

Symbol	Test Condition	Value	Unit
V_{RRM}		1600	V
$I_{T(AV)}$	$T_C=90^{\circ}\text{C}$, 180° conduction, half sine wave;	100	A
I_{TSM}	$T_J=45^{\circ}\text{C}$, $t=10\text{ms}$ (50Hz), sine, $V_R=V_{RRM}$;	1550	A
	$T_J=45^{\circ}\text{C}$, $t=8.3\text{ms}$ (60Hz), sine, $V_R=V_{RRM}$;	1650	
I^2t	$T_J=45^{\circ}\text{C}$, $t=10\text{ms}$ (50Hz), sine, $V_R=V_{RRM}$;	12.0	kA^2s
	$T_J=45^{\circ}\text{C}$, $t=8.3\text{ms}$ (60Hz), sine, $V_R=V_{RRM}$;	11.3	
dV/dt	$T_J=125^{\circ}\text{C}$, exponential to 67% rated V_{DRM}	1000	V/us
dI/dt	$T_J=125^{\circ}\text{C}$, $I_{TM}=300\text{A}$ rated V_{DRM}	150	A/us
V_{ISOL}	50Hz, all terminals shorted, $t=1\text{s}$, $I_{ISOL}\leq 1\text{mA}$;	3000	V~
T_J	Max. junction operating temperature range	-40~125	$^{\circ}\text{C}$
T_{STG}	Max. storage temperature range	-40~125	$^{\circ}\text{C}$
	Mounting torque(M6)	3 to 5	N·m
	Terminal connection torque(M6)	3 to 5	N·m
	Terminal connection torque(M4)	1 to 2	N·m

ELECTRICAL AND THERMAL CHARACTERISTICS

$T_C=25^{\circ}\text{C}$ unless otherwise specified

Symbol	Test Condition	Min.	Typ.	Max.	Unit
I_{DRM}/I_{RRM}	$T_J=125^{\circ}\text{C}$, $V_D=V_R=1600\text{V}$;			20	mA
V_{TM}	$I_{TM}=314\text{A}$, $t_d=10\text{ms}$, half sine;		1.54		V
V_{GT}	$V_A=6\text{V}$, $R_A=1\Omega$, $T_J=-40^{\circ}\text{C}$;			4	V
	$V_A=6\text{V}$, $R_A=1\Omega$;			2.5	
	$V_A=6\text{V}$, $R_A=1\Omega$, $T_J=125^{\circ}\text{C}$;			1.7	
I_{GT}	$V_A=6\text{V}$, $R_A=1\Omega$, $T_J=-40^{\circ}\text{C}$;			200	mA
	$V_A=6\text{V}$, $R_A=1\Omega$;			150	
	$V_A=6\text{V}$, $R_A=1\Omega$, $T_J=125^{\circ}\text{C}$;			80	
P_{GM}	$t_p\leq 5\text{ms}$, $T_J=125^{\circ}\text{C}$;			12	W
$P_{GM(AV)}$	$f=50\text{Hz}$, $T_J=125^{\circ}\text{C}$;			3	W
R_{thjc}	Thermal Resistance , Junction-to-Case			0.24	K/W
R_{THCS}	Thermal Resistance, Case -to-Sink			0.12	K/W

Characteristic curves

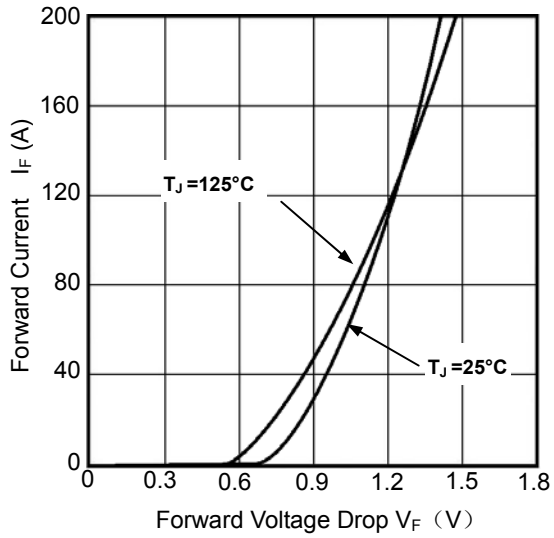

Figure 1. Diode Forward Voltage Drop vs Forward Current

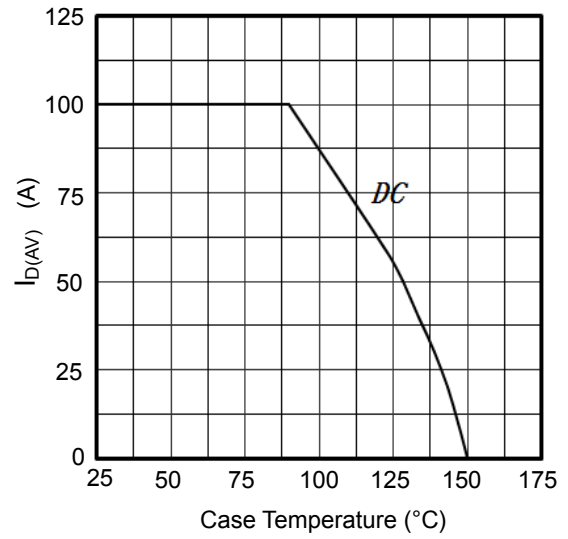

Figure 2. Diode $I_{D(AV)}$ vs Case Temperature

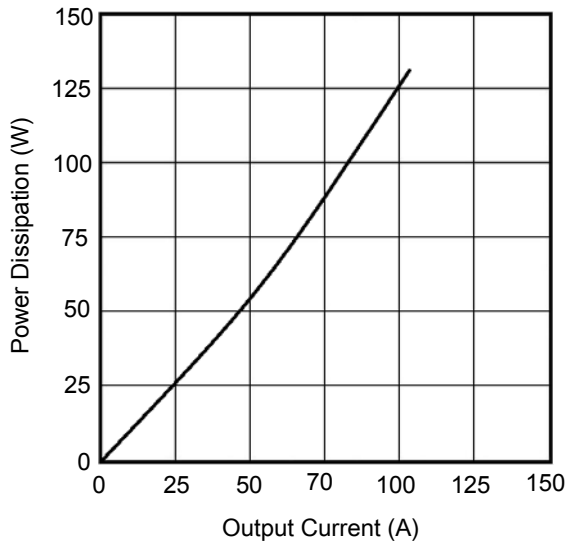

Figure 3. SCR Output Current vs Power Dissipation

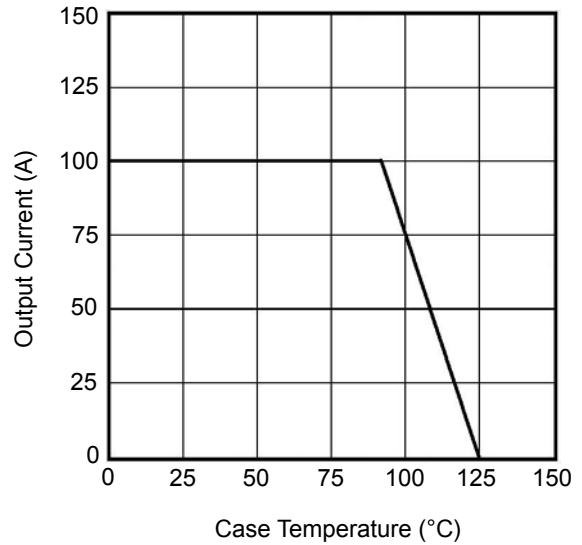

Figure 4. SCR Output Current vs Case Temperature

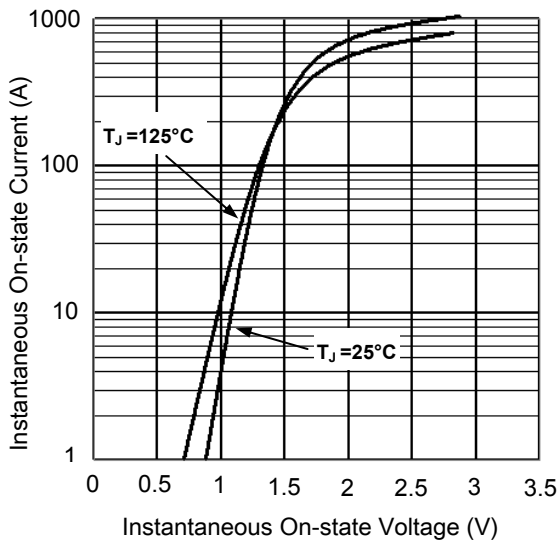

Figure 5. SCR On State Voltage Drop

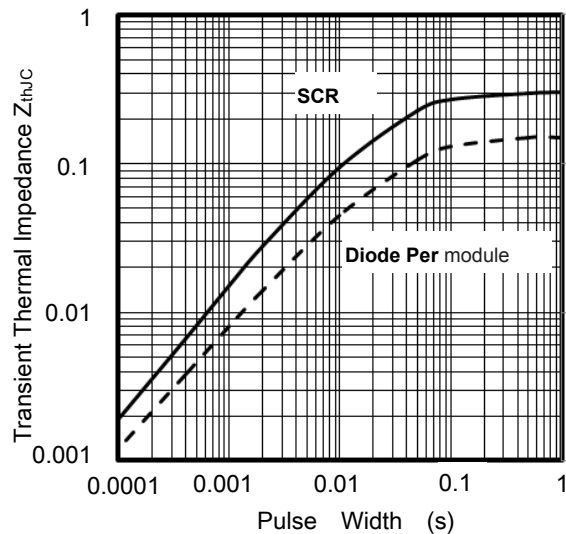

Figure 6. Diode and SCR Thermal Impedance Z_{thJC}

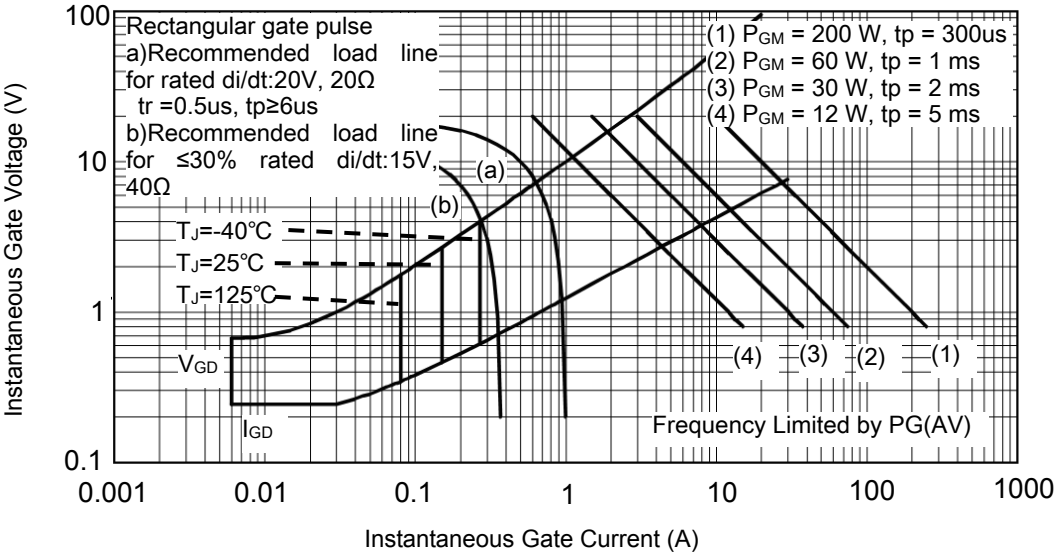

Figure 7. Gate Characteristics

Package Outline (Dimensions in mm)

