

## FEATURES

- Ultra Low Loss
- High Ruggedness
- High Short Circuit Capability
- Positive Temperature Coefficient
- With Fast Free-Wheeling Diodes

## APPLICATIONS

- Invector
- Converter
- Welder
- SMPS and UPS
- Induction Heating



## ABSOLUTE MAXIMUM RATINGS

$T_C=25^{\circ}\text{C}$  unless otherwise specified

Symbol	Parameter	Test Conditions	Values	Unit
<b>IGBT</b>				
$V_{CES}$	Collector - Emitter Voltage		1200	V
$V_{GES}$	Gate - Emitter Voltage		$\pm 20$	V
$I_C$	DC Collector Current	$T_C=25^{\circ}\text{C}$	105	A
		$T_C=80^{\circ}\text{C}$	75	A
$I_{Cpuls}$	Pulsed Collector Current	$T_C=25^{\circ}\text{C}, t_p=1\text{ms}$	210	A
		$T_C=80^{\circ}\text{C}, t_p=1\text{ms}$	150	A
$P_{tot}$	Power Dissipation Per IGBT		630	W
$T_J$	Junction Temperature Range		-40 to +150	$^{\circ}\text{C}$
$T_{STG}$	Storage Temperature Range		-40 to +125	$^{\circ}\text{C}$
$V_{isol}$	Insulation Test Voltage	AC, $t=1\text{min}$	3000	V
<b>Free-Wheeling Diode</b>				
$V_{RRM}$	Repetitive Reverse Voltage		1200	V
$I_{F(AV)}$	Average Forward Current	$T_C=25^{\circ}\text{C}$	90	A
		$T_C=80^{\circ}\text{C}$	60	A
$I_{F(RMS)}$	RMS Forward Current		90	A
$I_{FSM}$	Non-Repetitive Surge Forward Current	$T_J=45^{\circ}\text{C}, t=10\text{ms}, \text{Sine}$	430	A
		$T_J=45^{\circ}\text{C}, t=8.3\text{ms}, \text{Sine}$	450	A

## MMG75SR120B

### ELECTRICAL CHARACTERISTICS

$T_C=25^\circ\text{C}$  unless otherwise specified

Symbol	Parameter	Test Conditions	Min.	Typ.	Max.	Unit
<b>IGBT</b>						
$V_{GE(th)}$	Gate - Emitter Threshold Voltage	$V_{CE}=V_{GE}, I_C=3\text{mA}$	5	6.2	7	V
$V_{CE(sat)}$	Collector - Emitter Saturation Voltage	$I_C=75\text{A}, V_{GE}=15\text{V}, T_J=25^\circ\text{C}$		1.8		V
		$I_C=75\text{A}, V_{GE}=15\text{V}, T_J=125^\circ\text{C}$		2.0		V
$I_{CES}$	Collector Leakage Current	$V_{CE}=1200\text{V}, V_{GE}=0\text{V}, T_J=25^\circ\text{C}$		0.2	0.5	mA
		$V_{CE}=1200\text{V}, V_{GE}=0\text{V}, T_J=125^\circ\text{C}$		2		mA
$I_{GES}$	Gate Leakage Current	$V_{CE}=0\text{V}, V_{GE}=\pm 20\text{V}$	-100		100	nA
$Q_{ge}$	Gate Charge	$V_{CC}=600\text{V}, I_C=75\text{A}, V_{GE}=\pm 15\text{V}$		780		nC
$C_{ies}$	Input Capacitance	$V_{CE}=25\text{V}, V_{GE}=0\text{V}, f=1\text{MHz}$		5.52		nF
$C_{oes}$	Output Capacitance			0.4		nF
$C_{res}$	Reverse Transfer Capacitance			0.26		nF
$t_{d(on)}$	Turn - on Delay Time	$V_{CC}=600\text{V}, I_C=75\text{A}$		150		ns
$t_r$	Rise Time	$R_G = 15 \Omega, V_{GE}=\pm 15\text{V}$		65		ns
$t_{d(off)}$	Turn - off Delay Time	$T_J=25^\circ\text{C}$		440		ns
$t_f$	Fall Time	Inductive Load		55		ns
$t_{d(on)}$	Turn - on Delay Time	$V_{CC}=600\text{V}, I_C=75\text{A}$		160		ns
$t_r$	Rise Time	$R_G = 15 \Omega, V_{GE}=\pm 15\text{V}$		65		ns
$t_{d(off)}$	Turn - off Delay Time	$T_J=125^\circ\text{C}$		500		ns
$t_f$	Fall Time	Inductive Load		70		ns
$E_{on}$	Turn - on Switching Energy	$V_{CC}=600\text{V}, I_C=75\text{A}$ $T_J=25^\circ\text{C}$		7.45		mJ
		$R_G = 15 \Omega$ $T_J=125^\circ\text{C}$		10.3		mJ
$E_{off}$	Turn - off Switching Energy	$V_{GE}=\pm 15\text{V}$ $T_J=25^\circ\text{C}$		4.9		mJ
		Inductive Load $T_J=125^\circ\text{C}$		7.8		mJ
<b>Free-Wheeling Diode</b>						
$V_F$	Forward Voltage	$I_F=75\text{A}, V_{GE}=0\text{V}, T_J=25^\circ\text{C}$		2.0	2.48	V
		$I_F=75\text{A}, V_{GE}=0\text{V}, T_J=125^\circ\text{C}$		1.7	2.20	V
$t_{rr}$	Reverse Recovery Time	$I_F=75\text{A}, V_R=800\text{V}$		200		ns
$I_{RRM}$	Max. Reverse Recovery Current	$di_F/dt=-1000\text{A}/\mu\text{s}$		70		A
$Q_{rr}$	Reverse Recovery Charge	$T_J=125^\circ\text{C}$		8.2		$\mu\text{C}$

### THERMAL AND MECHANICAL CHARACTERISTICS

Symbol	Parameter	Test Conditions	Min.	Typ.	Max.	Unit
$R_{thJC}$	Junction-to-Case Thermal Resistance	Per IGBT			0.2	K /W
$R_{thJCD}$	Junction-to-Case Thermal Resistance	Per Inverse Diode			0.5	K /W
Torque	To-Sink	Recommended (M6)	3		5	N · m
Torque	To-Terminal	Recommended (M5)	2.5		5	N · m
Weight				150		g

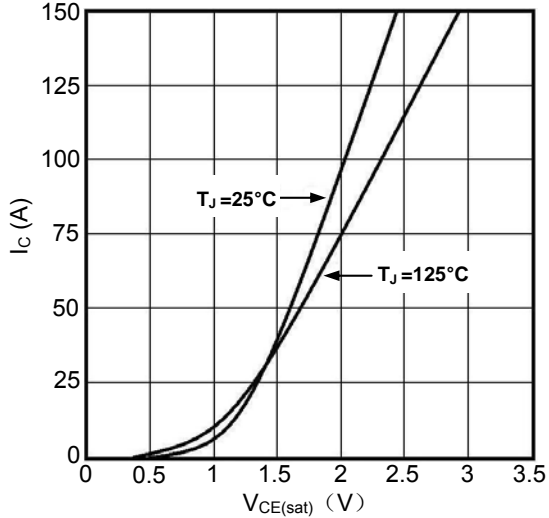

Figure1. Typical Output characteristics

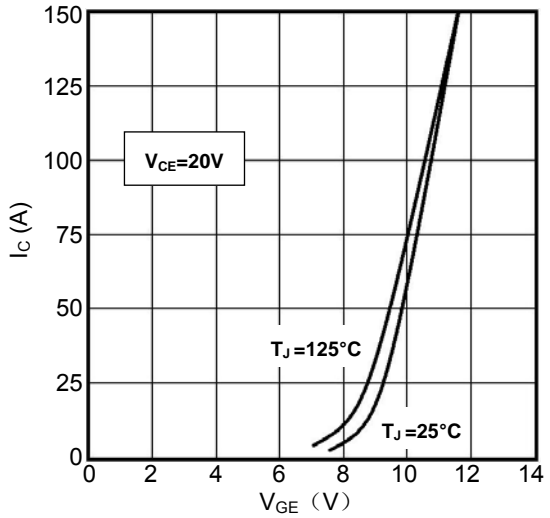

Figure2. Typical Transfer characteristics

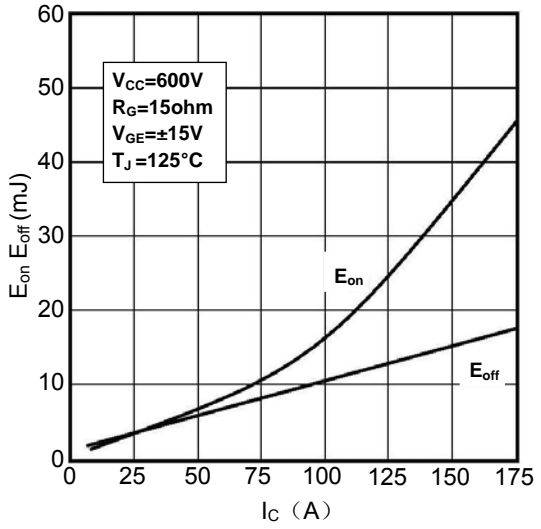

Figure3. Switching Energy vs. Collector Current

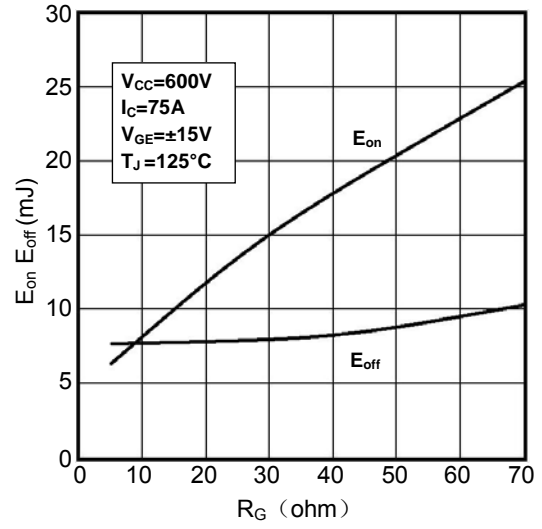

Figure4. Switching Energy vs. Gate Resistor

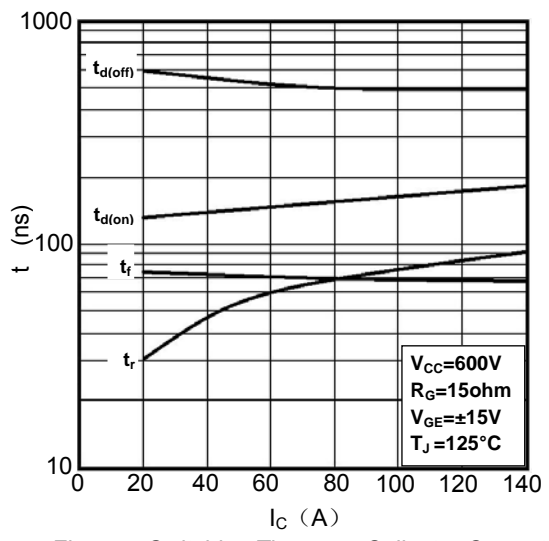

Figure5. Switching Times vs. Collector Current

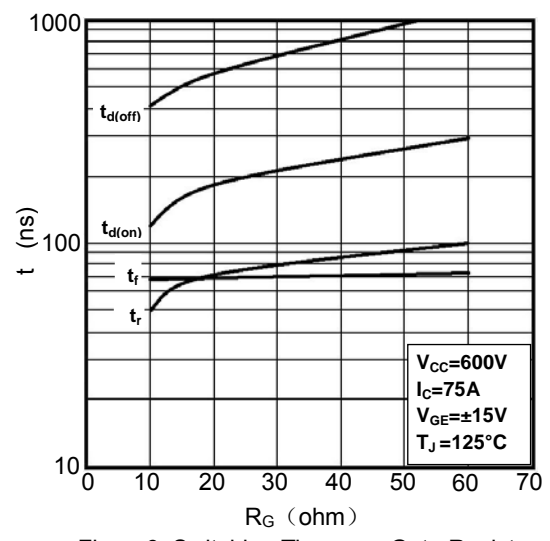

Figure6. Switching Times vs. Gate Resistor

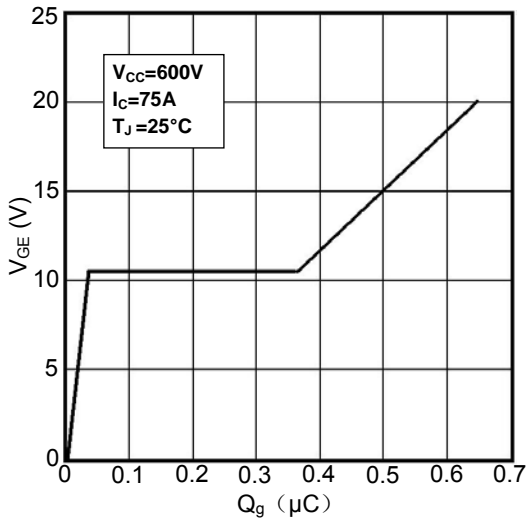

Figure7. Gate Charge characteristics

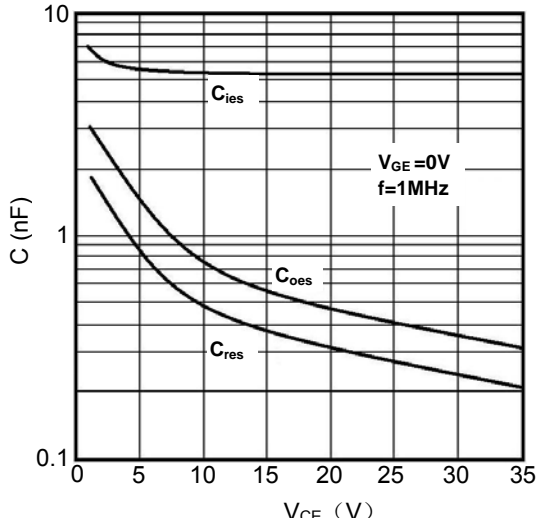

Figure8. Typical Capacitances vs. VCE

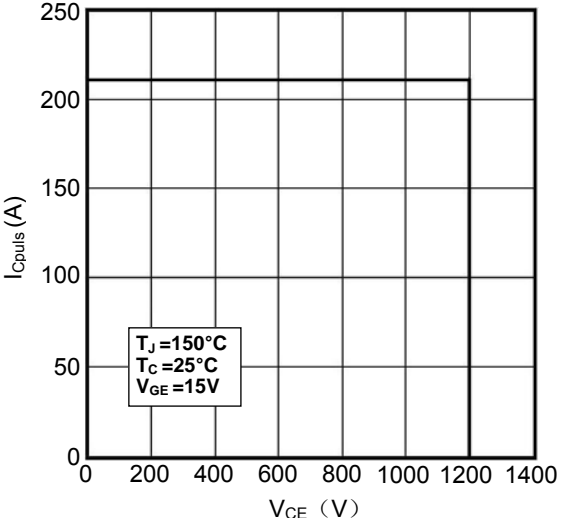

Figure9. Reverse Biased Safe Operating Area

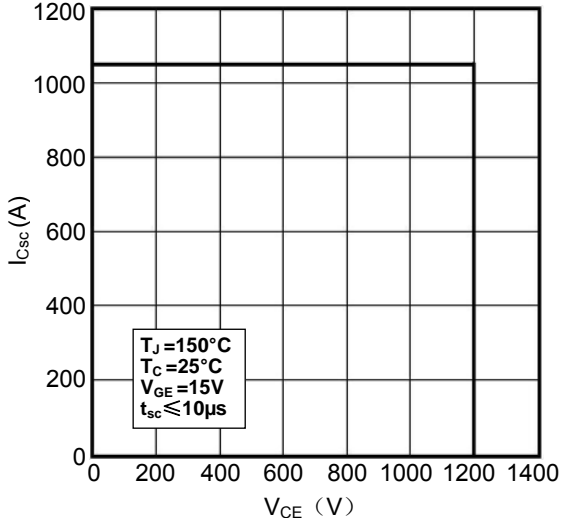

Figure10. Short Circuit Safe Operating Area

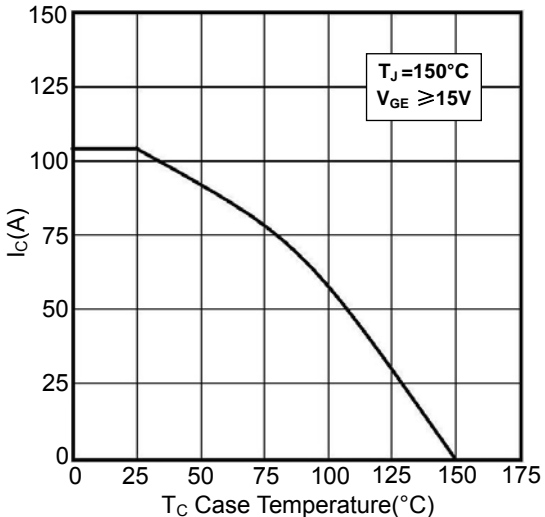

Figure11. Rated Current vs. TC

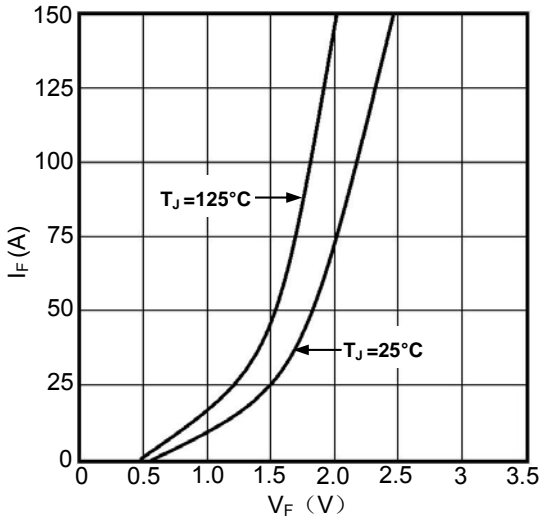
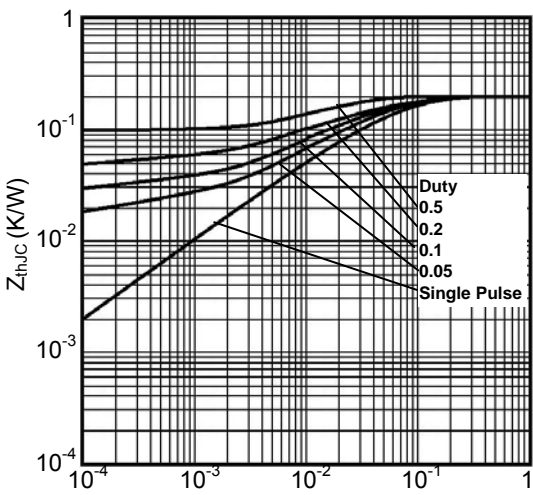
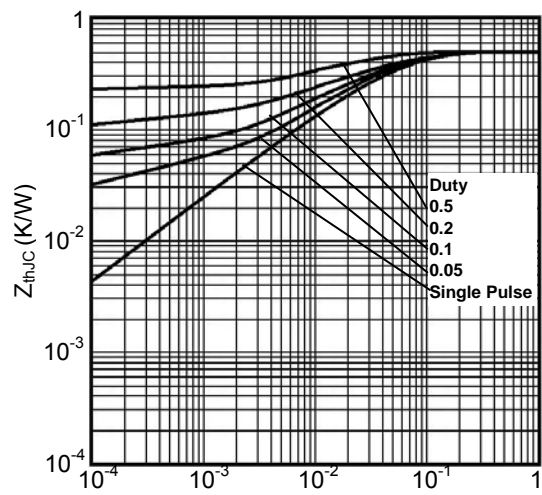

Figure12. Diode Forward Characteristics



Rectangular Pulse Duration (seconds)  
Figure13. Transient Thermal Impedance of IGBT



Rectangular Pulse Duration (seconds)  
Figure14. Transient Thermal Impedance of Diode

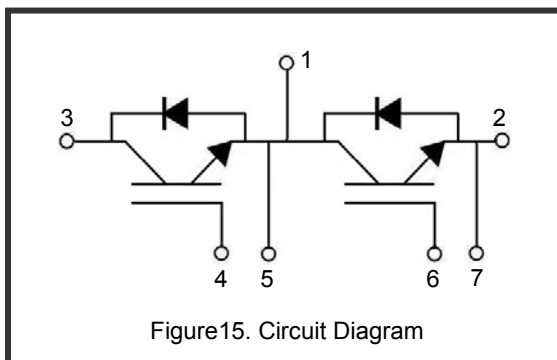
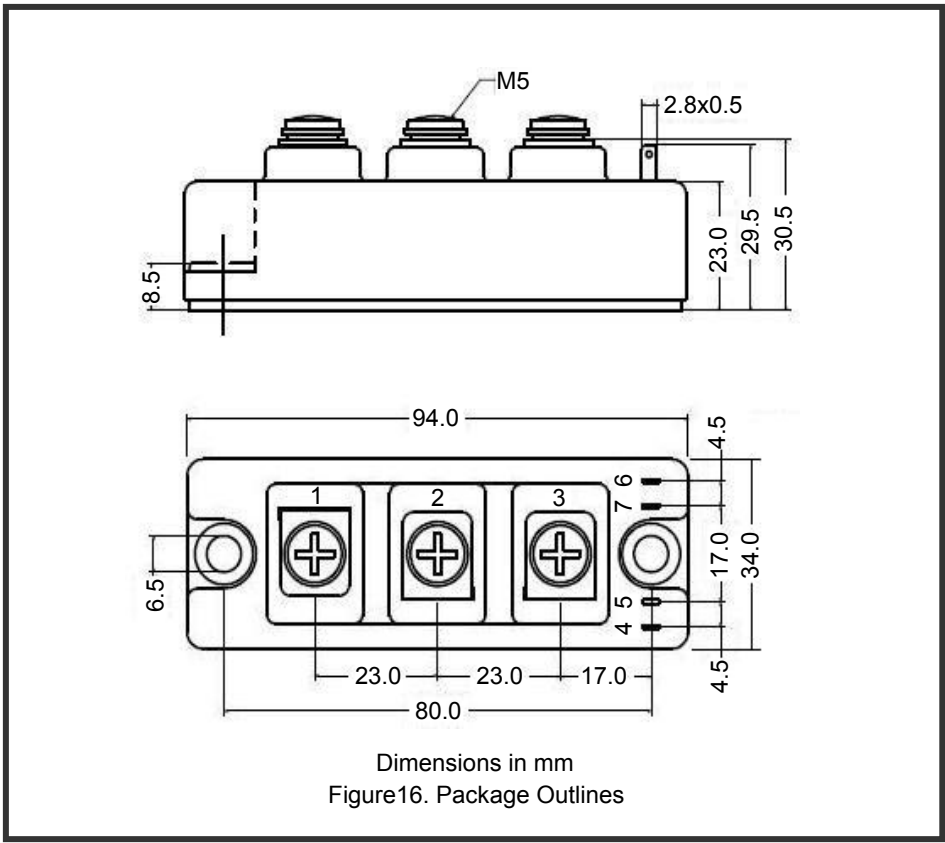

Figure15. Circuit Diagram



Dimensions in mm  
Figure16. Package Outlines