

PRODUCT FEATURES

- IGBT³ CHIP(Trench+Field Stop technology)
- High short circuit capability,self limiting short circuit current
- $V_{CE(sat)}$ with positive temperature coefficient
- Fast switching and short tail current
- Free wheeling diodes with fast and soft reverse recovery
- Low switching losses



APPLICATIONS

- High frequency switching application
- Medical applications
- Motion/servo control
- UPS systems

IGBT-inverter

ABSOLUTE MAXIMUM RATINGS

$T_C=25^\circ\text{C}$ unless otherwise specified

Symbol	Parameter/Test Conditions		Values	Unit
V_{CES}	Collector Emitter Voltage	$T_J=25^\circ\text{C}$	1200	V
V_{GES}	Gate Emitter Voltage		± 20	
I_C	DC Collector Current	$T_C=25^\circ\text{C}$	450	A
		$T_C=80^\circ\text{C}$	300	
I_{CM}	Repetitive Peak Collector Current	$t_p=1\text{ms}$	600	
P_{tot}	Power Dissipation Per IGBT		1450	W

Diode-inverter

ABSOLUTE MAXIMUM RATINGS

$T_C=25^\circ\text{C}$ unless otherwise specified

Symbol	Parameter/Test Conditions		Values	Unit
V_{RRM}	Repetitive Reverse Voltage	$T_J=25^\circ\text{C}$	1200	V
$I_{F(AV)}$	Average Forward Current	$T_C=25^\circ\text{C}$	300	A
I_{FRM}	Repetitive Peak Forward Current	$t_p=1\text{ms}$	600	
i^2t		$T_J=125^\circ\text{C}, t=10\text{ms}, V_R=0\text{V}$	19000	A^2S

IGBT-inverter
ELECTRICAL CHARACTERISTICS
 $T_C=25^\circ\text{C}$ unless otherwise specified

Symbol	Parameter/Test Conditions		Min.	Typ.	Max.	Unit	
$V_{GE(th)}$	Gate Emitter Threshold Voltage	$V_{CE}=V_{GE}, I_C=12\text{mA}$	5.0	5.8	6.5	V	
$V_{CE(sat)}$	Collector Emitter Saturation Voltage	$I_C=300\text{A}, V_{GE}=15\text{V}, T_J=25^\circ\text{C}$		1.7	2.15		
		$I_C=300\text{A}, V_{GE}=15\text{V}, T_J=125^\circ\text{C}$		1.9			
I_{CES}	Collector Leakage Current	$V_{CE}=1200\text{V}, V_{GE}=0\text{V}, T_J=25^\circ\text{C}$			1	mA	
		$V_{CE}=1200\text{V}, V_{GE}=0\text{V}, T_J=125^\circ\text{C}$			10	mA	
I_{GES}	Gate Leakage Current	$V_{CE}=0\text{V}, V_{GE}=\pm 15\text{V}, T_J=25^\circ\text{C}$	-400		400	nA	
R_{gint}	Integrated Gate Resistor			2.5		Ω	
Q_g	Gate Charge	$V_{CE}=600\text{V}, I_C=300\text{A}, V_{GE}=\pm 15\text{V}$		2.8		μC	
C_{ies}	Input Capacitance	$V_{CE}=25\text{V}, V_{GE}=0\text{V}, f=1\text{MHz}$		21		nF	
C_{res}	Reverse Transfer Capacitance				850		pF
$t_{d(on)}$	Turn on Delay Time	$V_{CC}=600\text{V}, I_C=300\text{A}$ $R_G=2.4\Omega,$ $V_{GE}=\pm 15\text{V},$ Inductive Load	$T_J=25^\circ\text{C}$		160		ns
			$T_J=125^\circ\text{C}$		170		ns
t_r	Rise Time		$T_J=25^\circ\text{C}$		40		ns
			$T_J=125^\circ\text{C}$		45		ns
$t_{d(off)}$	Turn off Delay Time	$V_{CC}=600\text{V}, I_C=300\text{A}$ $R_G=2.4\Omega,$ $V_{GE}=\pm 15\text{V},$ Inductive Load	$T_J=25^\circ\text{C}$		450		ns
			$T_J=125^\circ\text{C}$		520		ns
t_f	Fall Time		$T_J=25^\circ\text{C}$		100		ns
			$T_J=125^\circ\text{C}$		160		ns
E_{on}	Turn on Energy	$V_{CC}=600\text{V}, I_C=300\text{A}$ $R_G=2.4\Omega,$ $V_{GE}=\pm 15\text{V},$ Inductive Load	$T_J=25^\circ\text{C}$		16.5		mJ
			$T_J=125^\circ\text{C}$		25		mJ
E_{off}	Turn off Energy		$T_J=25^\circ\text{C}$		24.5		mJ
			$T_J=125^\circ\text{C}$		37.0		mJ
I_{sc}	Short Circuit Current	$tpsc \leq 10\mu\text{S}, V_{GE}=15\text{V}$ $T_J=125^\circ\text{C}, V_{CC}=900\text{V}$		1200		A	
R_{thJC}	Junction to Case Thermal Resistance (Per IGBT)				0.085	K /W	

Diode-inverter
ELECTRICAL CHARACTERISTICS
 $T_C=25^\circ\text{C}$ unless otherwise specified

Symbol	Parameter/Test Conditions		Min.	Typ.	Max.	Unit
V_F	Forward Voltage	$I_F=300\text{A}, V_{GE}=0\text{V}, T_J=25^\circ\text{C}$		1.65	2.15	V
		$I_F=300\text{A}, V_{GE}=0\text{V}, T_J=125^\circ\text{C}$		1.65		
t_{rr}	Reverse Recovery Time	$I_F=300\text{A}, V_R=600\text{V}$		300		ns
I_{RRM}	Max. Reverse Recovery Current	$di_F/dt=-6000\text{A}/\mu\text{s}$		270		A
Q_{RR}	Reverse Recovery Charge	$T_J=125^\circ\text{C}$		56		μC
E_{rec}	Reverse Recovery Energy			26		mJ
R_{thJCD}	Junction to Case Thermal Resistance (Per Diode)				0.15	K /W

MODULE CHARACTERISTICS

$T_C=25^{\circ}\text{C}$ unless otherwise specified

Symbol	Parameter/Test Conditions		Values	Unit
T_{Jmax}	Max. Junction Temperature		150	°C
T_{Jop}	Operating Temperature		-40~125	
T_{stg}	Storage Temperature		-40~125	
V_{isol}	Isolation Breakdown Voltage	AC, 50Hz(R.M.S), t=1minute	3000	V
CTI	Comparative Tracking Index		> 225	
Torque	to heatsink	Recommended (M6)	3~5	Nm
	to terminal	Recommended (M6)	2.5~5	Nm
Weight			300	g

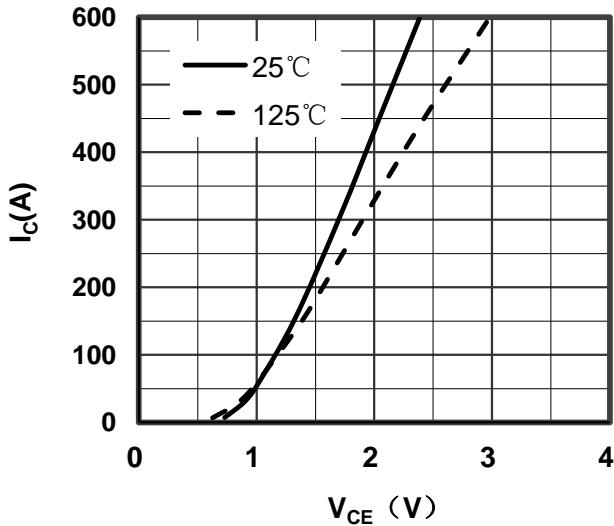

Figure 1. Typical Output Characteristics IGBT-inverter

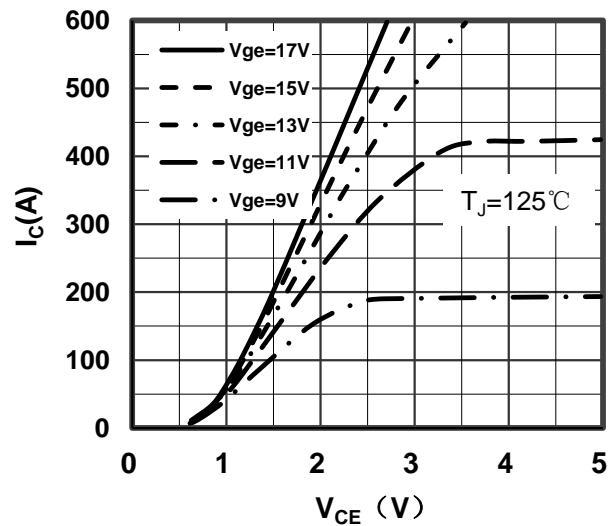

Figure 2. Typical Output Characteristics IGBT-inverter

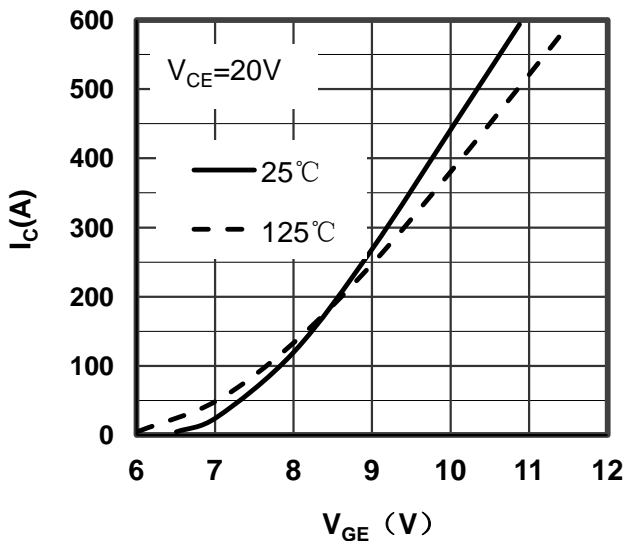

Figure 3. Typical Transfer characteristics IGBT-inverter

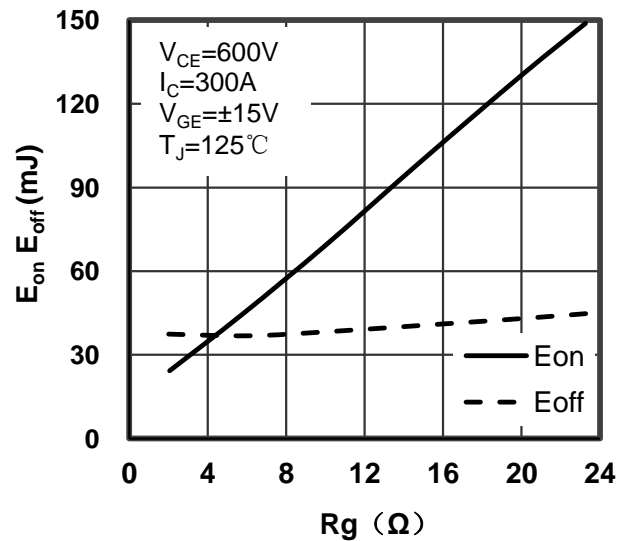

Figure 4. Switching Energy vs Gate Resistor IGBT-inverter

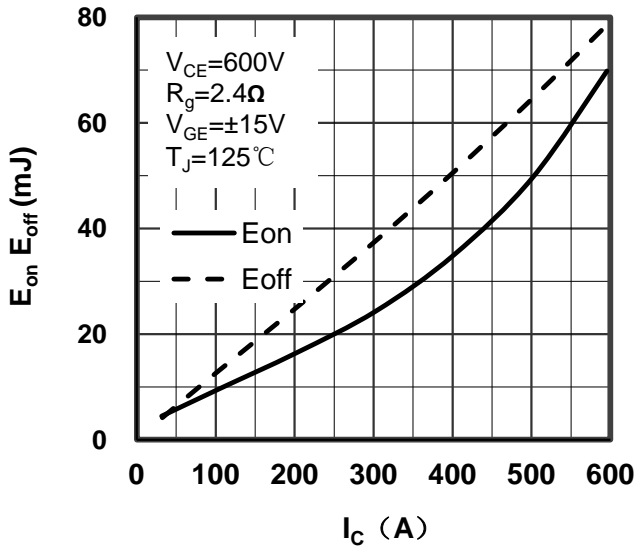

Figure 5. Switching Energy vs Collector Current IGBT-inverter

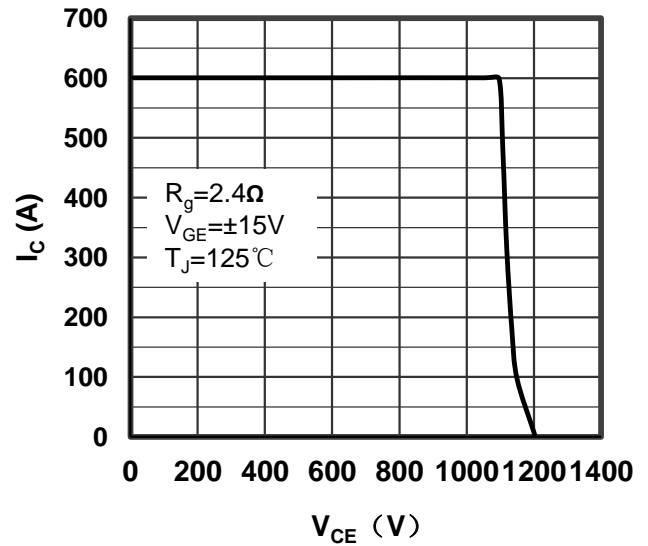

Figure 6. Reverse Biased Safe Operating Area IGBT-inverter

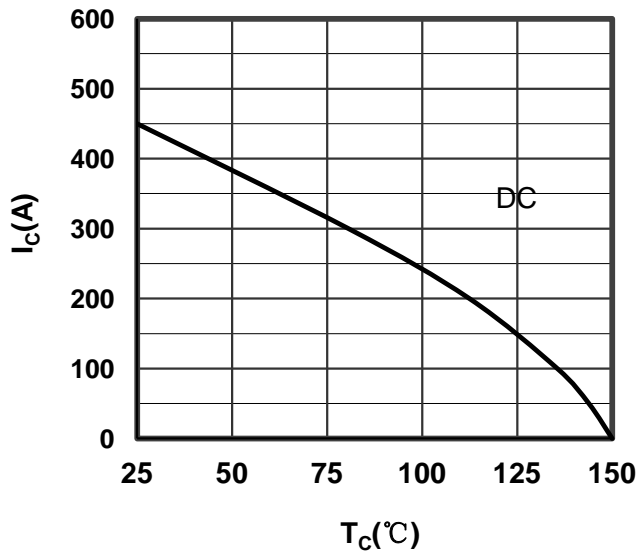

Figure 7. Collector Current vs Case temperature IGBT -inverter

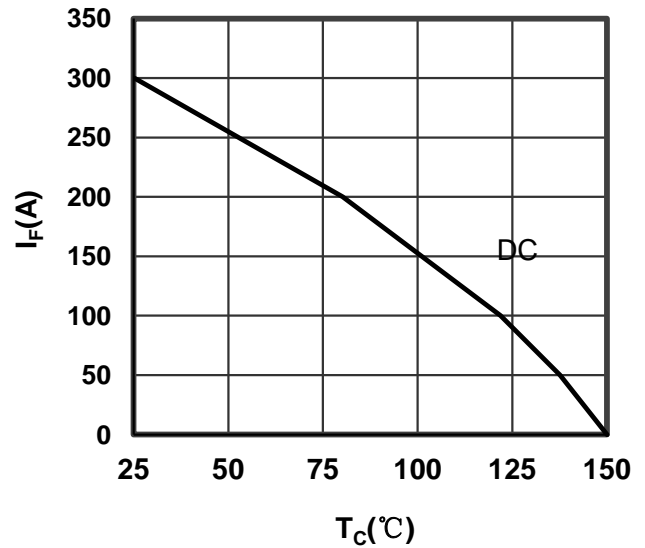

Figure 8. Forward current vs Case temperature Diode -inverter

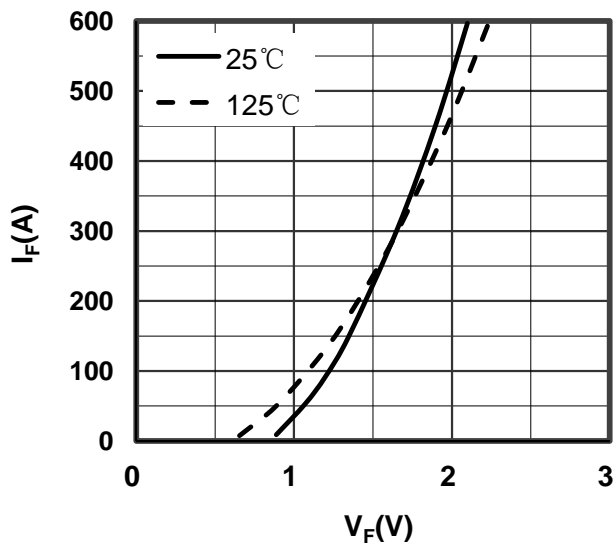

Figure 9. Diode Forward Characteristics Diode -inverter

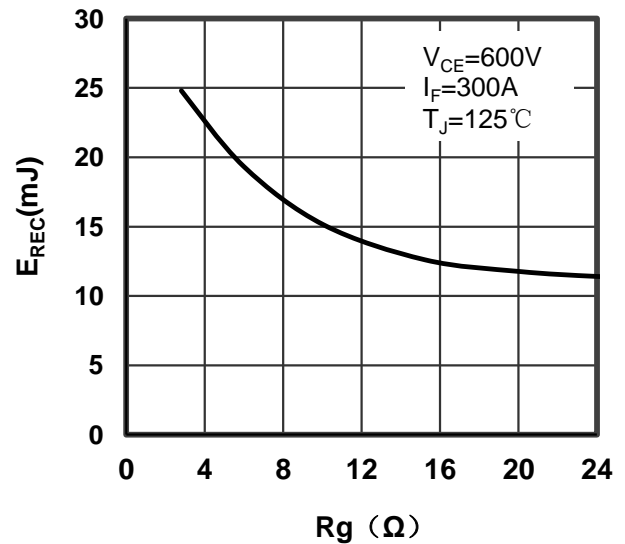

Figure 10. Switching Energy vs Gate Resistor Diode -inverter

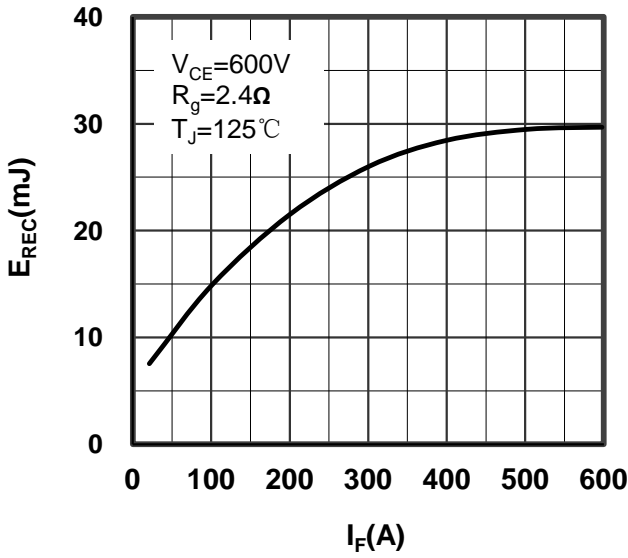

Figure 11. Switching Energy vs Forward Current Diode-inverter

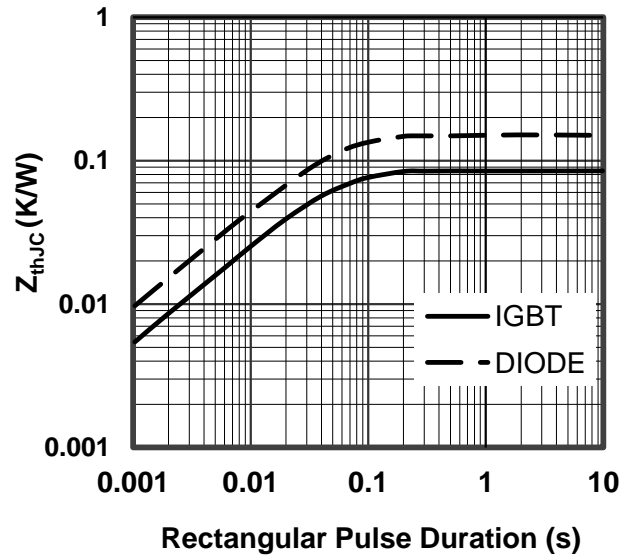

Figure 12. Transient Thermal Impedance of Diode and IGBT-inverter

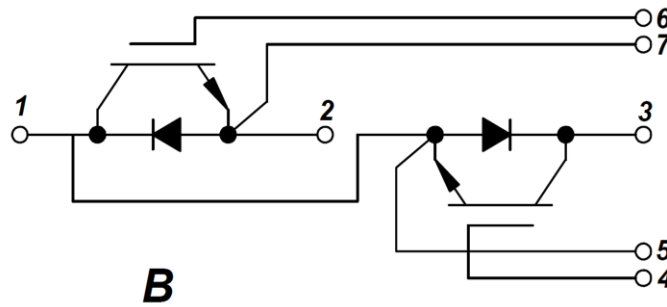
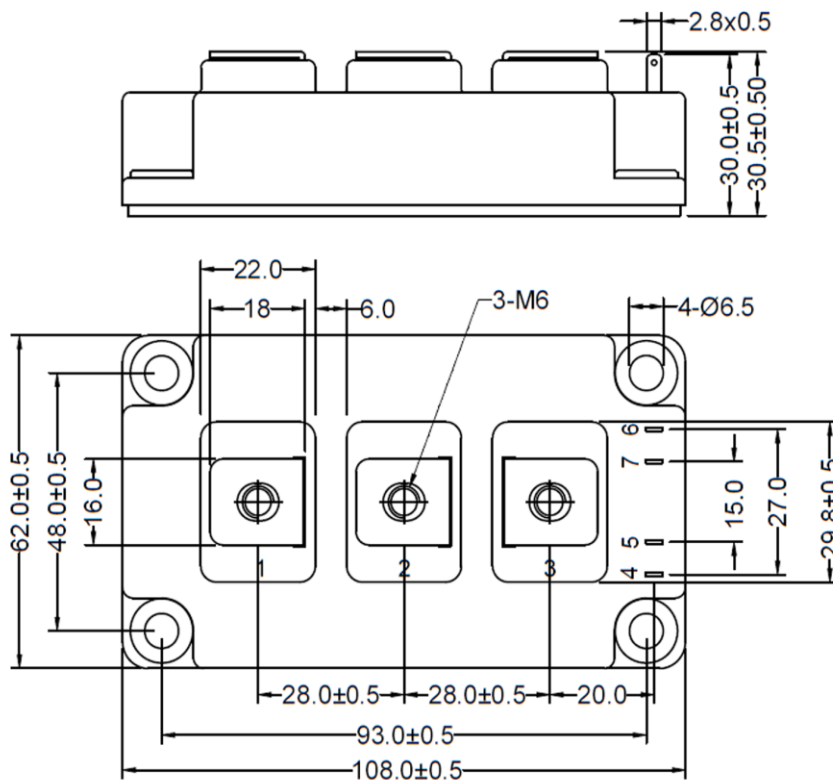

Figure 13. Circuit Diagram



Dimensions in (mm)
Figure 14. Package Outline