

FEATURES

- Ultra Low Loss
- High Ruggedness
- High Short Circuit Capability
- Positive Temperature Coefficient
- Integrated Gate Resistor

APPLICATIONS

- Invector
- Converter
- Welder
- SMPS and UPS
- Induction Heating



ABSOLUTE MAXIMUM RATINGS

$T_C=25^{\circ}\text{C}$ unless otherwise specified

Symbol	Parameter	Test Conditions	Values	Unit
IGBT				
V_{CES}	Collector - Emitter Voltage		600	V
V_{GES}	Gate - Emitter Voltage		± 20	V
I_C	DC Collector Current	$T_C=25^{\circ}\text{C}$	360	A
		$T_C=60^{\circ}\text{C}$	300	A
I_{Cpuls}	Pulsed Collector Current	$T_C=25^{\circ}\text{C}, t_p=1\text{ms}$	720	A
		$T_C=60^{\circ}\text{C}, t_p=1\text{ms}$	600	A
P_{tot}	Power Dissipation Per IGBT		1250	W
T_J	Junction Temperature Range		-40 to +150	$^{\circ}\text{C}$
T_{STG}	Storage Temperature Range		-40 to +125	$^{\circ}\text{C}$
V_{isol}	Insulation Test Voltage	AC, $t=1\text{min}$	3000	V
Free-Wheeling Diode				
V_{RRM}	Repetitive Reverse Voltage		600	V
$I_{F(AV)}$	Average Forward Current	$T_C=25^{\circ}\text{C}$	300	A
		$T_C=60^{\circ}\text{C}$	250	A
$I_{F(RMS)}$	RMS Forward Current		440	A
I_{FSM}	Non-Repetitive Surge	$T_J=45^{\circ}\text{C}, t=10\text{ms}, \text{Sine}$	1000	A
	Forward Current	$T_J=45^{\circ}\text{C}, t=8.3\text{ms}, \text{Sine}$	1090	A

MMG300D060B6N

ELECTRICAL CHARACTERISTICS

T_C=25°C unless otherwise specified

Symbol	Parameter	Test Conditions	Min.	Typ.	Max.	Unit
IGBT						
V _{GE(th)}	Gate - Emitter Threshold Voltage	V _{CE} =V _{GE} , I _C =6mA	4.5	5.5	6.5	V
V _{CE(sat)}	Collector - Emitter Saturation Voltage	I _C =300A, V _{GE} =15V, T _J =25°C		1.95	2.45	V
		I _C =300A, V _{GE} =15V, T _J =125°C		2.2		V
I _{CEs}	Collector Leakage Current	V _{CE} =600V, V _{GE} =0V, T _J =25°C			1	mA
		V _{CE} =600V, V _{GE} =0V, T _J =125°C		2		mA
I _{GES}	Gate Leakage Current	V _{CE} =0V, V _{GE} =±20V	-0.8		0.8	μA
R _{Gint}	Integrated Gate Resistor			2.5	3.5	Ω
Q _{ge}	Gate Charge	V _{CC} =300V, I _C =300A, V _{GE} =±15V		1480		nC
C _{ies}	Input Capacitance	V _{CE} =25V, V _{GE} =0V, f=1MHz		13		nF
C _{oes}	Output Capacitance			1.4		nF
C _{res}	Reverse Transfer Capacitance			1.2		nF
t _{d(on)}	Turn - on Delay Time	V _{CC} =300V, I _C =300A		125		ns
t _r	Rise Time	R _G =3 Ω, V _{GE} =±15V		65		ns
t _{d(off)}	Turn - off Delay Time	T _J =25°C		300		ns
t _f	Fall Time	Inductive Load		40		ns
t _{d(on)}	Turn - on Delay Time	V _{CC} =300V, I _C =300A		135		ns
t _r	Rise Time	R _G =3 Ω, V _{GE} =±15V		70		ns
t _{d(off)}	Turn - off Delay Time	T _J =125°C		330		ns
t _f	Fall Time	Inductive Load		45		ns
E _{on}	Turn - on Switching Energy	V _{CC} =300V, I _C =300A, T _J =25°C		4		mJ
		R _G =3 Ω, T _J =125°C		6		mJ
E _{off}	Turn - off Switching Energy	V _{GE} =±15V, T _J =25°C		6		mJ
		Inductive Load, T _J =125°C		10		mJ
Free-Wheeling Diode						
V _F	Forward Voltage	I _F =300A, V _{GE} =0V, T _J =25°C		1.25	1.6	V
		I _F =300A, V _{GE} =0V, T _J =125°C		1.2		V
t _{rr}	Reverse Recovery Time	I _F =300A, V _R =300V		240		ns
I _{RRM}	Max. Reverse Recovery Current	di _F /dt=-2000A/μs		170		A
Q _{rr}	Reverse Recovery Charge	T _J =125°C		24		μC

THERMAL AND MECHANICAL CHARACTERISTICS

Symbol	Parameter	Test Conditions	Min.	Typ.	Max.	Unit
R _{thJC}	Junction-to-Case Thermal Resistance	Per IGBT			0.1	K/W
R _{thJD}	Junction-to-Case Thermal Resistance	Per Inverse Diode			0.25	K/W
Torque	To-Sink	Recommended (M6)	3		5	N·m
Torque	To-Terminal	Recommended (M6)	2.5		5	N·m
Weight				310		g

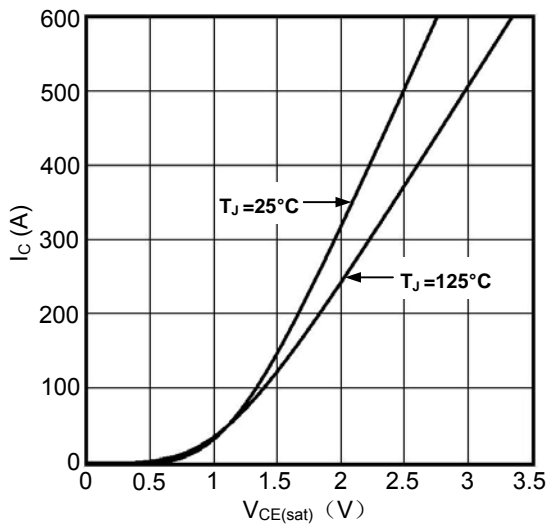

Figure1. Typical Output characteristics

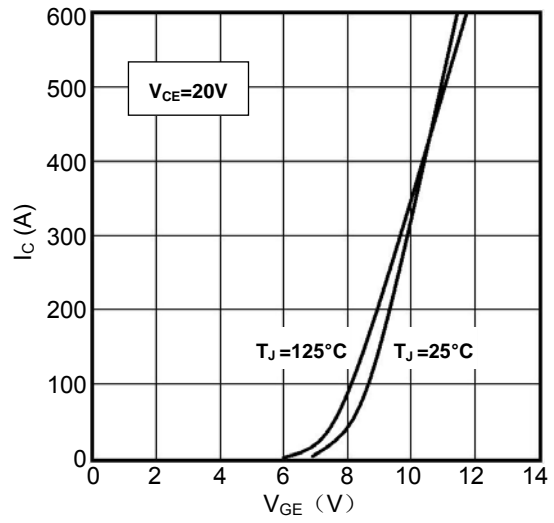

Figure2. Typical Transfer characteristics

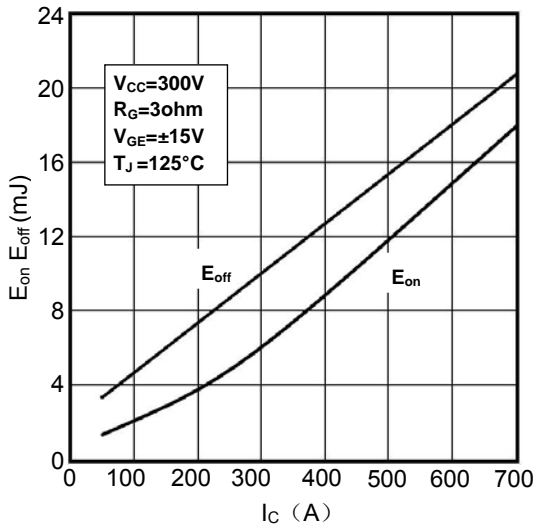

Figure3. Switching Energy vs. Collector Current

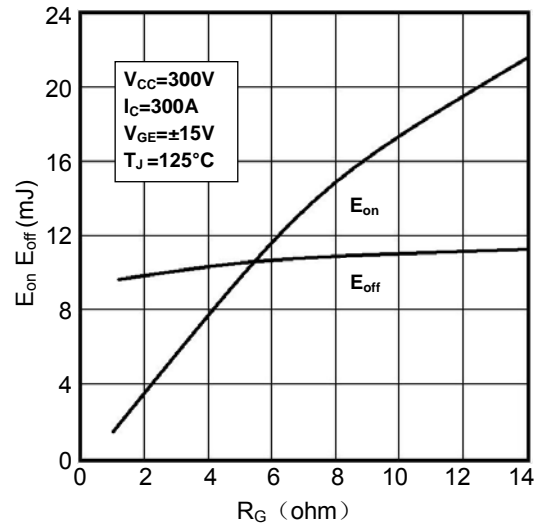

Figure4. Switching Energy vs. Gate Resistor

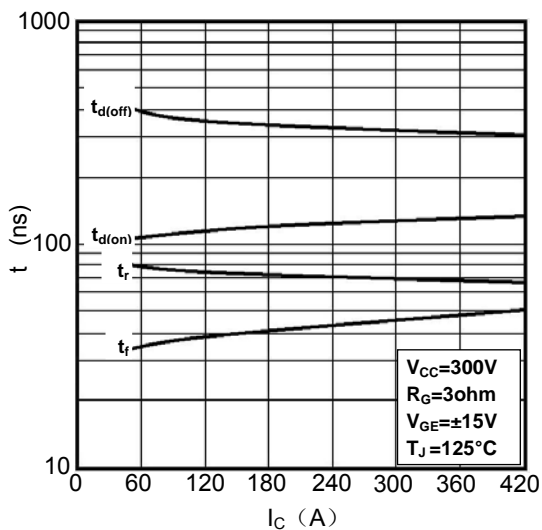

Figure5. Switching Times vs. Collector Current

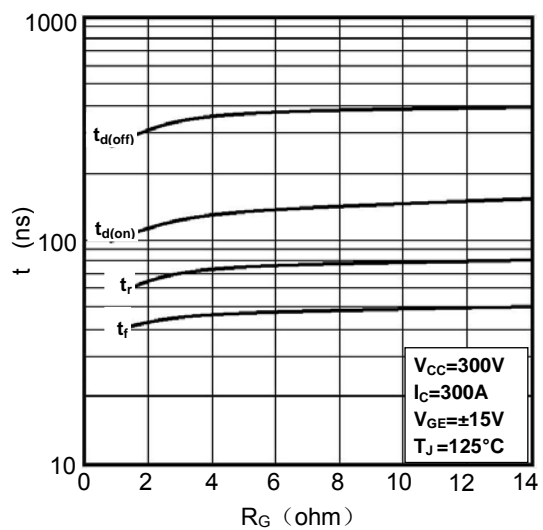

Figure6. Switching Times vs. Gate Resistor

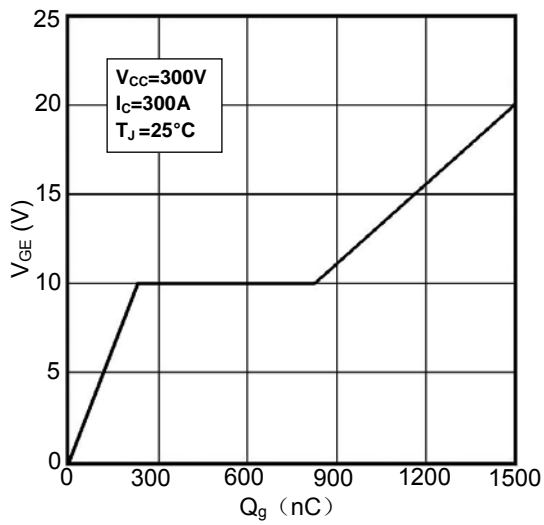

Figure7. Gate Charge characteristics

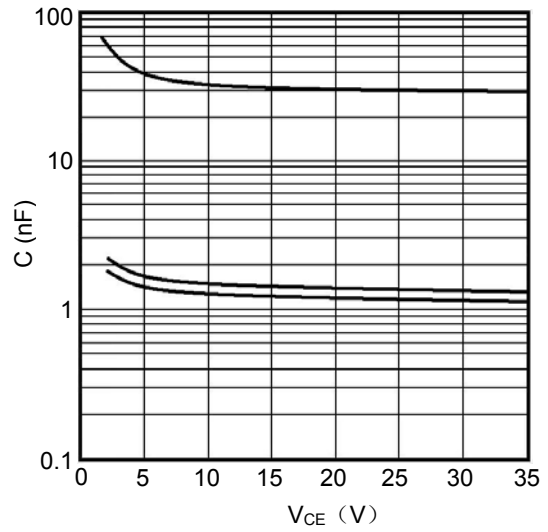

Figure8. Typical Capacitances vs. V_{CE}

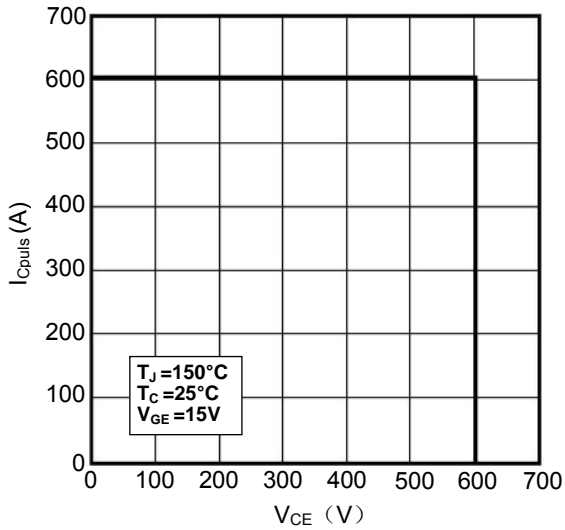

Figure9. Reverse Biased Safe Operating Area

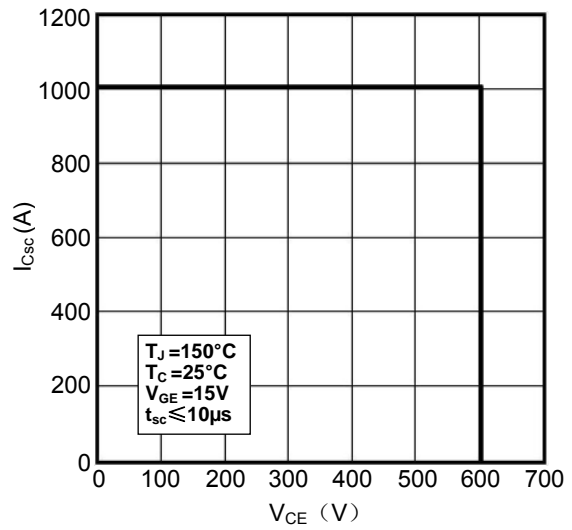

Figure10. Short Circuit Safe Operating Area

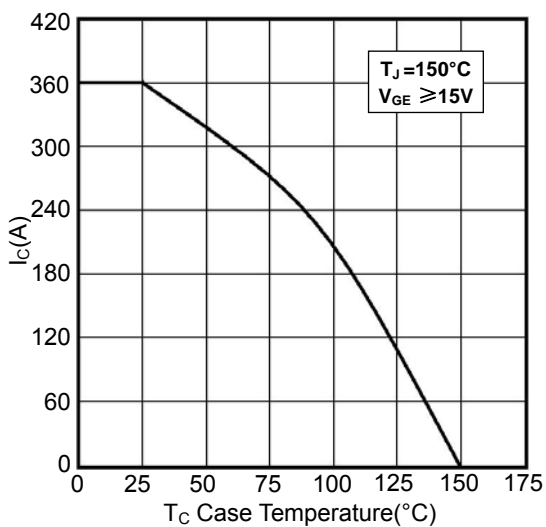

Figure11. Rated Current vs. T_C

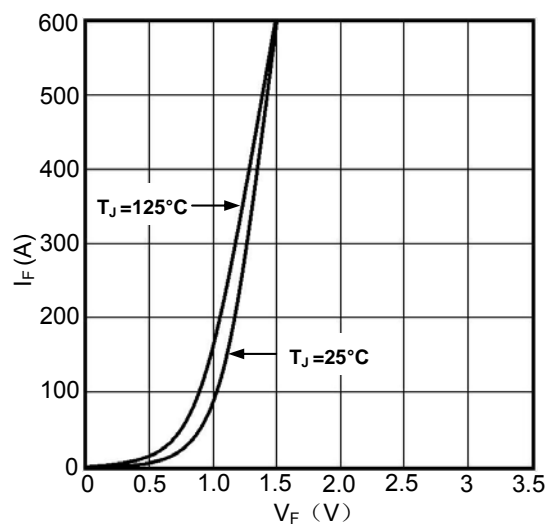
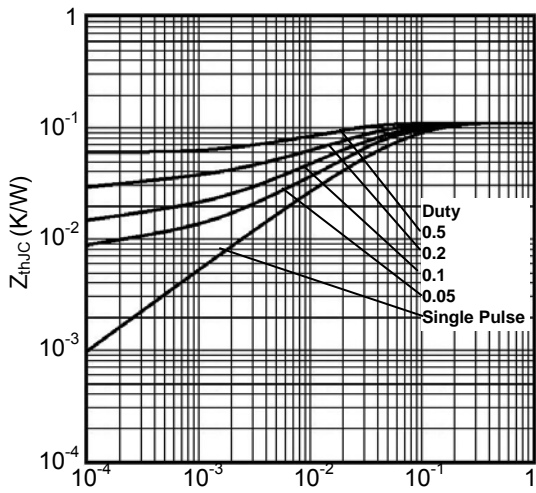
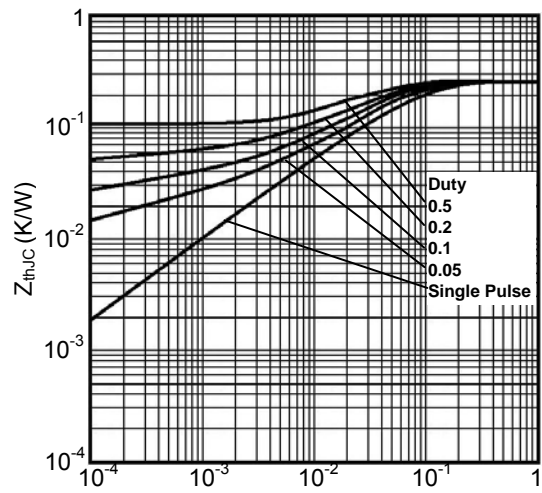

Figure12. Diode Forward Characteristics



Rectangular Pulse Duration (seconds)
Figure13. Transient Thermal Impedance of IGBT



Rectangular Pulse Duration (seconds)
Figure14. Transient Thermal Impedance of Diode

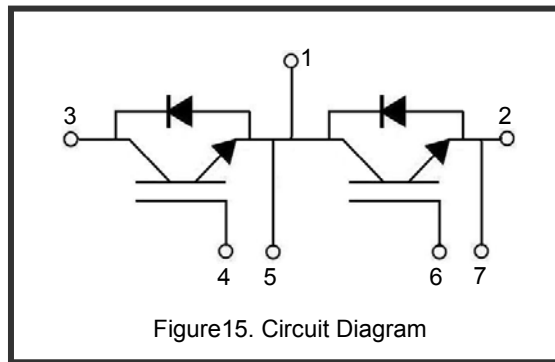
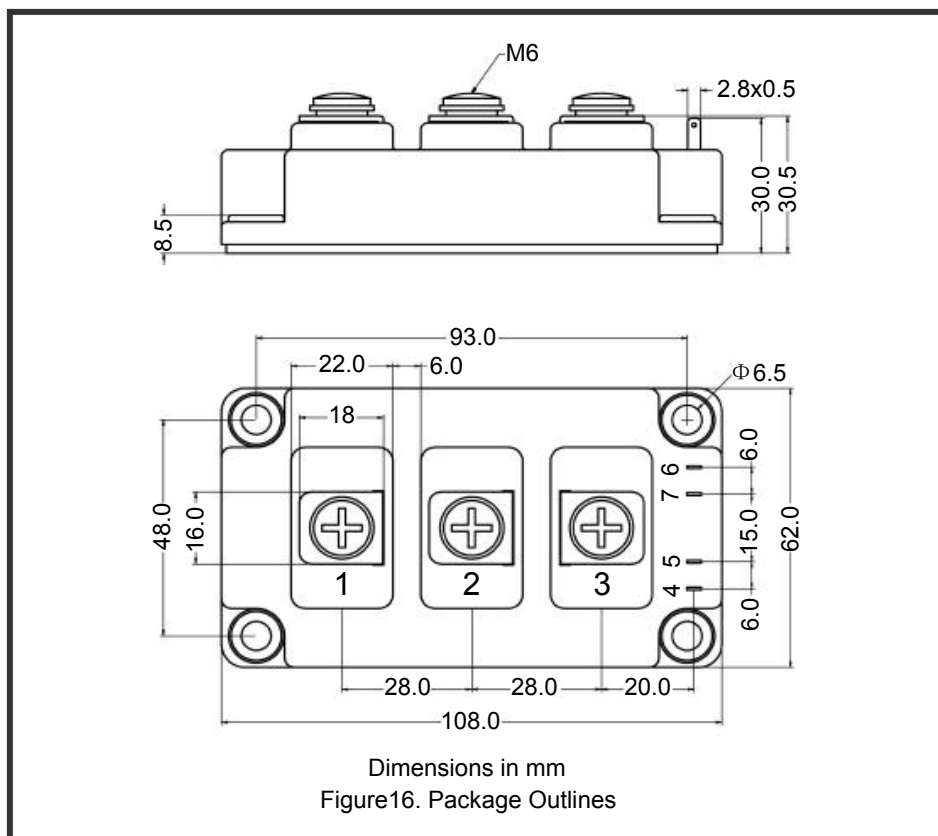

Figure15. Circuit Diagram



Dimensions in mm
Figure16. Package Outlines