

## FEATURES

- High short circuit capability, self limiting short circuit current
- IGBT<sup>3</sup> CHIP (Trench+Field Stop technology)
- $V_{CE(sat)}$  with positive temperature coefficient
- Fast switching and short tail current
- Free wheeling diodes with fast and soft reverse recovery
- Low switching losses

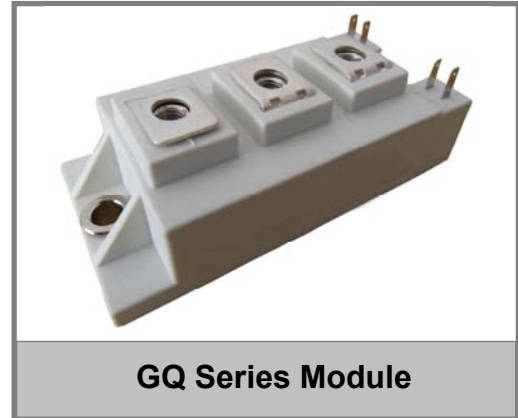

## APPLICATIONS

- High frequency switching application
- Medical applications
- Motion/servo control
- UPS systems

## ABSOLUTE MAXIMUM RATINGS

$T_C=25^{\circ}\text{C}$  unless otherwise specified

Symbol	Parameter	Test Conditions	Values	Unit
<b>IGBT</b>				
$V_{CES}$	Collector - Emitter Voltage	$T_{vj}=25^{\circ}\text{C}$	1200	V
$V_{GES}$	Gate - Emitter Voltage		$\pm 20$	V
$I_C$	DC Collector Current	$T_C=25^{\circ}\text{C}$	290	A
		$T_C=80^{\circ}\text{C}$	200	A
$I_{CM}$	Repetitive Peak Collector Current	$t_p=1\text{ms}$	400	A
$P_{tot}$	Power Dissipation Per IGBT		1050	W
<b>Diode</b>				
$V_{RRM}$	Repetitive Reverse Voltage	$T_{vj}=25^{\circ}\text{C}$	1200	V
$I_{F(AV)}$	Average Forward Current	$T_C=25^{\circ}\text{C}$	290	A
		$T_C=80^{\circ}\text{C}$	200	A
$I_{FRM}$	Repetitive Peak Forward Current	$t_p=1\text{ms}$	400	A
$I^2t$		$T_{vj}=125^{\circ}\text{C}, t=10\text{ms}, V_R=0\text{V}$	7750	$\text{A}^2\text{s}$

## MMG200Q120B6TN

### ELECTRICAL AND THERMAL CHARACTERISTICS $T_C=25^\circ\text{C}$ unless otherwise specified

Symbol	Parameter	Test Conditions	Min.	Typ.	Max.	Unit
<b>IGBT</b>						
$V_{GE(th)}$	Gate - Emitter Threshold Voltage	$V_{CE}=V_{GE}, I_C=8\text{mA}$	5.0	5.8	6.5	V
$V_{CE(sat)}$	Collector - Emitter Saturation Voltage	$I_C=200\text{A}, V_{GE}=15\text{V}, T_{Vj}=25^\circ\text{C}$		1.7		V
		$I_C=200\text{A}, V_{GE}=15\text{V}, T_{Vj}=125^\circ\text{C}$		1.9		V
$I_{CES}$	Collector Leakage Current	$V_{CE}=1200\text{V}, V_{GE}=0\text{V}, T_{Vj}=25^\circ\text{C}$			1	mA
		$V_{CE}=1200\text{V}, V_{GE}=0\text{V}, T_{Vj}=125^\circ\text{C}$			5	mA
$I_{GES}$	Gate Leakage Current	$V_{CE}=0\text{V}, V_{GE} \pm 15\text{V}, T_{Vj}=125^\circ\text{C}$	-400		400	nA
$R_{Gint}$	Integrated Gate Resistor			3.8		$\Omega$
$Q_{ge}$	Gate Charge	$V_{CE}=600\text{V}, I_C=200\text{A}, V_{GE}=\pm 15\text{V}$		1.9		$\mu\text{C}$
$C_{ies}$	Input Capacitance	$V_{CE}=25\text{V}, V_{GE}=0\text{V}, f=1\text{MHz}$		14		nF
$C_{res}$	Reverse Transfer Capacitance			0.5		nF
$t_{d(on)}$	Turn - on Delay Time	$V_{CC}=600\text{V}, I_C=200\text{A}, T_{Vj}=25^\circ\text{C}$		160		ns
		$R_G=3.6\ \Omega, T_{Vj}=125^\circ\text{C}$		170		ns
$t_r$	Rise Time	$V_{GE}=\pm 15\text{V}, T_{Vj}=25^\circ\text{C}$		40		ns
		Inductive Load $T_{Vj}=125^\circ\text{C}$		45		ns
$t_{d(off)}$	Turn - off Delay Time	$V_{CC}=600\text{V}, I_C=200\text{A}, T_{Vj}=25^\circ\text{C}$		450		ns
		$R_G=3.6\ \Omega, T_{Vj}=125^\circ\text{C}$		520		ns
$t_f$	Fall Time	$V_{GE}=\pm 15\text{V}, T_{Vj}=25^\circ\text{C}$		100		ns
		Inductive Load $T_{Vj}=125^\circ\text{C}$		160		ns
$E_{on}$	Turn - on Energy	$V_{CC}=600\text{V}, I_C=200\text{A}, T_{Vj}=25^\circ\text{C}$		10		mJ
		$R_G=3.6\ \Omega, T_{Vj}=125^\circ\text{C}$		15		mJ
$E_{off}$	Turn - off Energy	$V_{GE}=\pm 15\text{V}, T_{Vj}=25^\circ\text{C}$		16.5		mJ
		Inductive Load $T_{Vj}=125^\circ\text{C}$		25		mJ
$I_{sc}$	Short Circuit Current	$t_{psc} \leq 10\ \mu\text{s}, V_{GE}=15\text{V}$ $T_{Vj}=125^\circ\text{C}, V_{CC}=900\text{V}$		800		A
$R_{thJC}$	Junction-to-Case Thermal Resistance ( Per IGBT )				0.12	K/W
<b>Diode</b>						
$V_F$	Forward Voltage	$I_F=200\text{A}, V_{GE}=0\text{V}, T_{Vj}=25^\circ\text{C}$		1.65		V
		$I_F=200\text{A}, V_{GE}=0\text{V}, T_{Vj}=125^\circ\text{C}$		1.65		V
$I_{RRM}$	Max. Reverse Recovery Current	$I_F=200\text{A}, V_R=600\text{V}$		190		A
$Q_{rr}$	Reverse Recovery Charge	$di_F/dt=-4000\text{A}/\mu\text{s}$		36		$\mu\text{C}$
$E_{rec}$	Reverse Recovery Energy	$T_{Vj}=125^\circ\text{C}$		17		mJ
$R_{thJCD}$	Junction-to-Case Thermal Resistance ( Per Diode )				0.20	K/W

**MODULE CHARACTERISTICS**

$T_C=25^{\circ}\text{C}$  unless otherwise specified

Symbol	Parameter	Test Conditions	Min.	Typ.	Max.	Unit
$T_{Vj\ max}$	Max. Junction Temperature				150	$^{\circ}\text{C}$
$T_{Vj\ op}$	Operating Temperature		-40		125	$^{\circ}\text{C}$
$T_{stg}$	Storage Temperature		-40		125	$^{\circ}\text{C}$
$V_{isol}$	Insulation Test Voltage	AC, t=1min		3000		V
CTI	Comparative Tracking Index		350			
Torque	Module-to-Sink	Recommended (M6)	3		5	N · m
Torque	Module Electrodes	Recommended (M6)	2.5		5	N · m
Weight				200		g

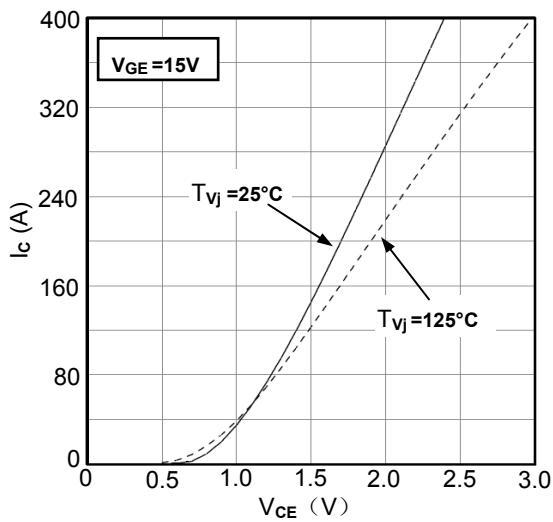

Figure1. Typical Output Characteristics

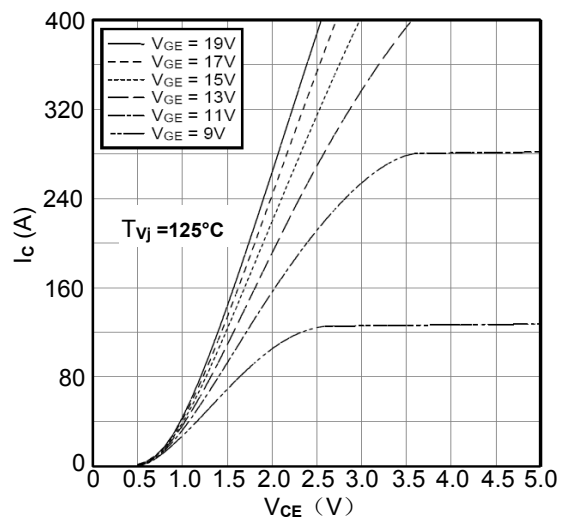

Figure2. Typical Output Characteristics

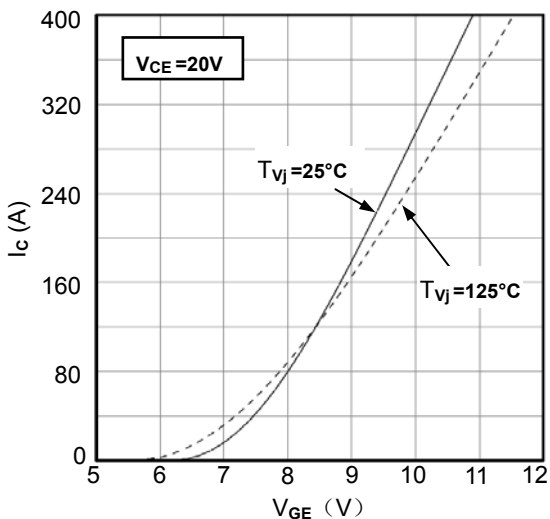

Figure3. Typical Transfer characteristics

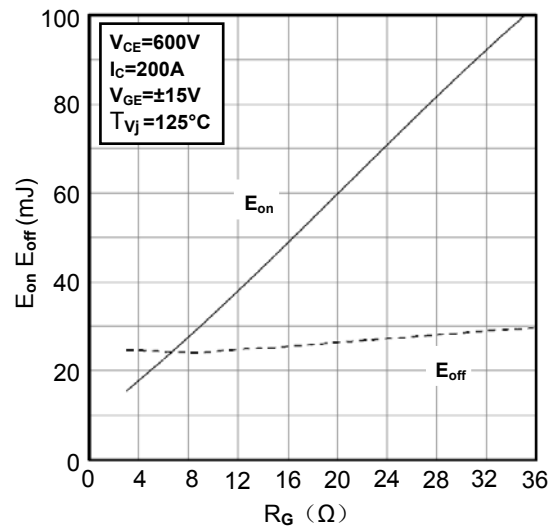

Figure4. Switching Energy vs. Gate Resistor

# MMG200Q120B6TN

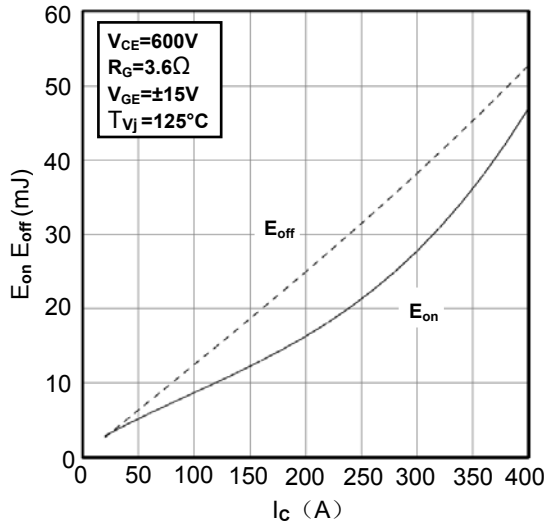

Figure 5. Switching Energy vs. Collector Current

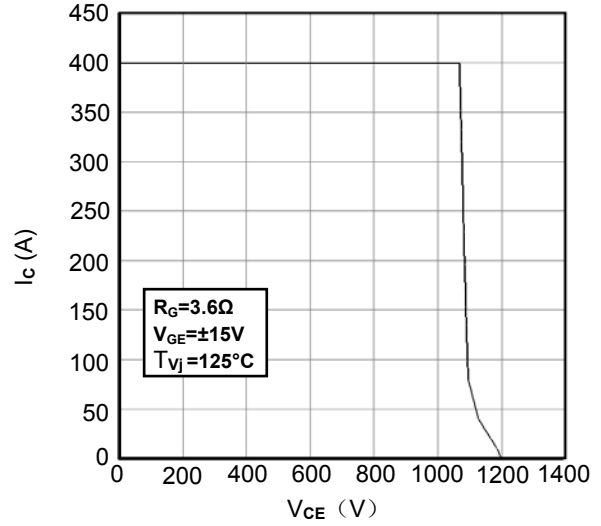

Figure 6. Reverse Biased Safe Operating Area

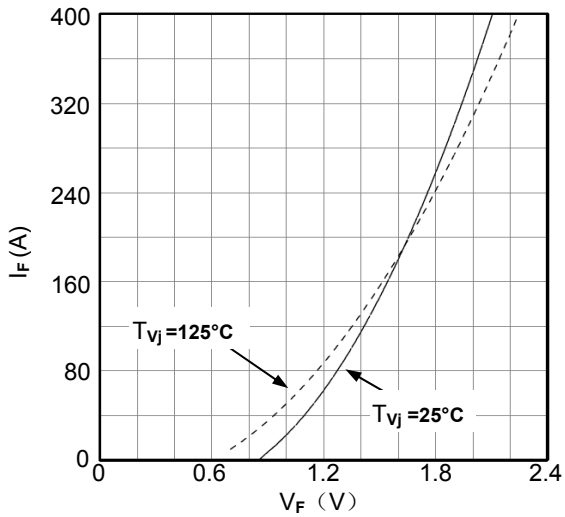

Figure 7. Diode Forward Characteristics

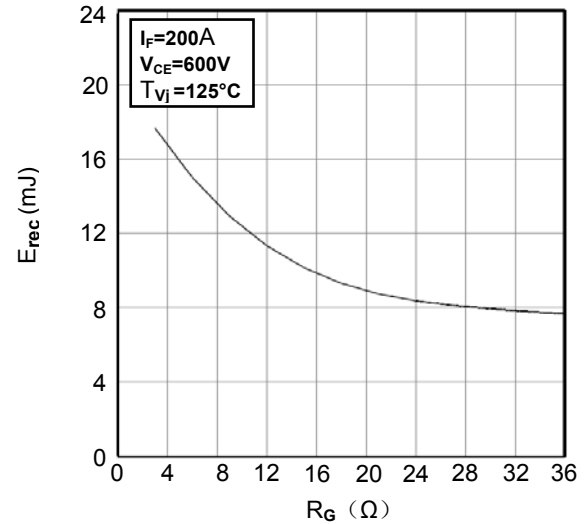

Figure 8. Switching Energy vs. Gate Resistor

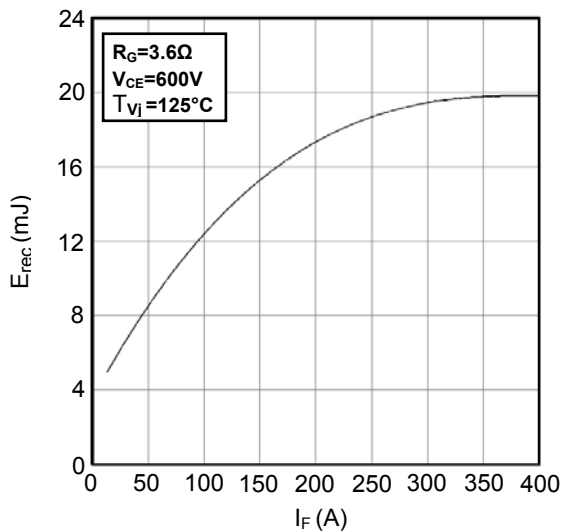

Figure 9. Switching Energy vs. Forward Current

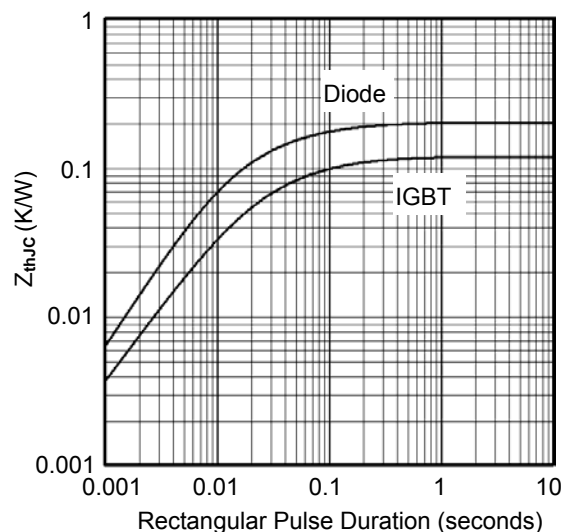

Figure 10. Transient Thermal Impedance

**MMG200Q120B6TN**

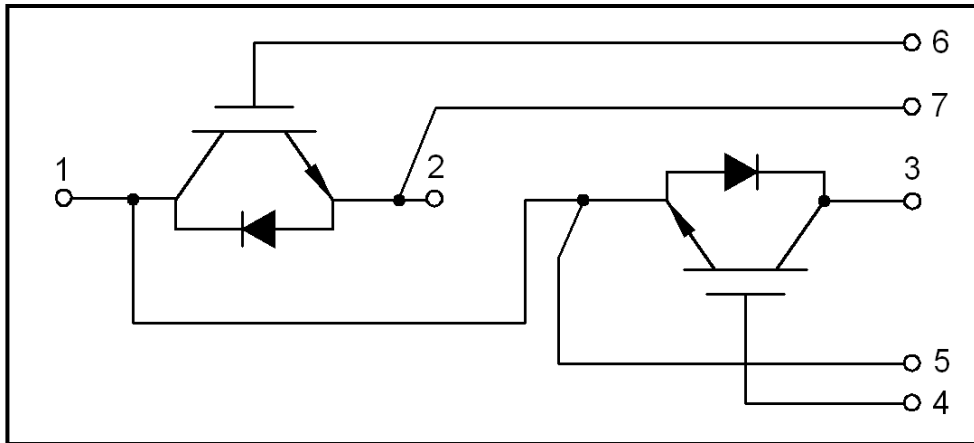
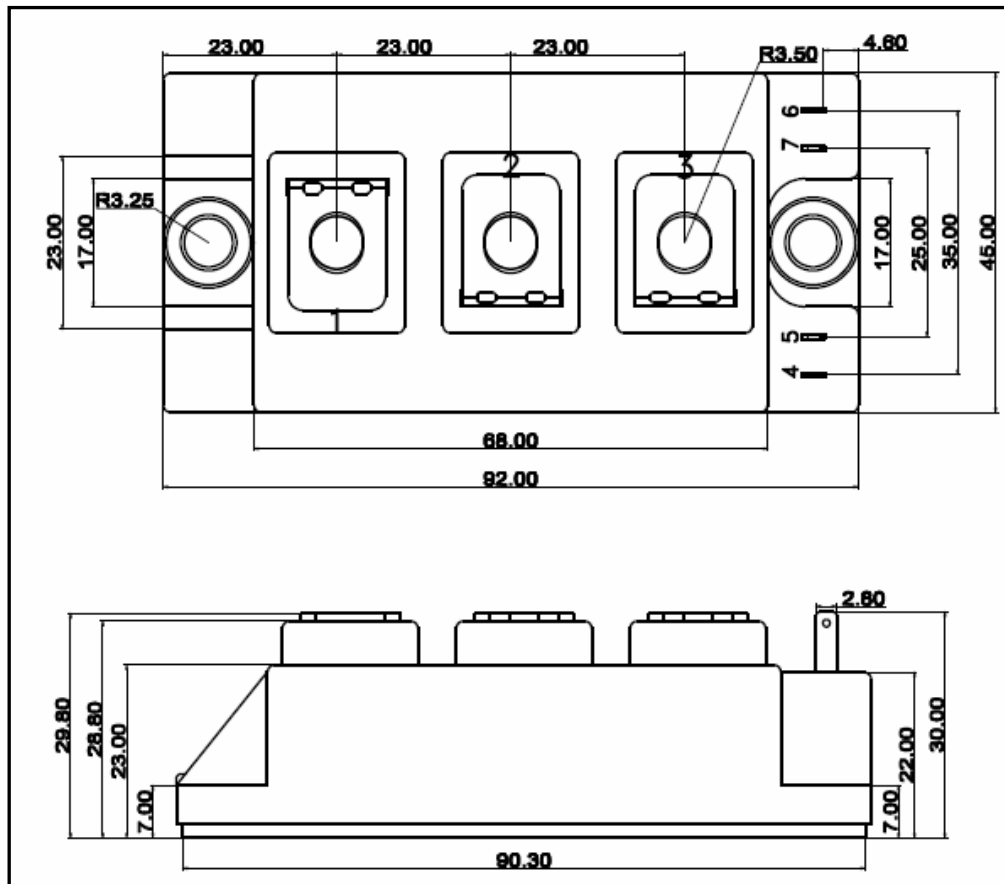

Figure11. Circuit Diagram



Dimensions (mm)  
Figure12. Package Outline