

FEATURES

- High short circuit capability, self limiting short circuit current
- IGBT CHIP(T4 Fast Trench+Field Stop technology)
- $V_{CE(sat)}$ with positive temperature coefficient
- Fast switching and short tail current
- Free wheeling diodes with fast and soft reverse recovery
- Low switching losses
- $T_{vj\ max} = 175^{\circ}C$

APPLICATIONS

- High frequency switching application
- Medical applications
- Motion/servo control
- UPS systems

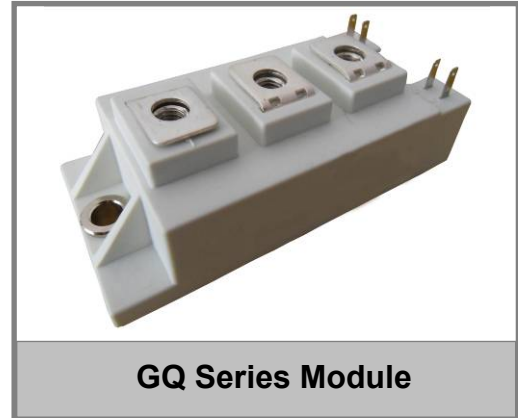

ABSOLUTE MAXIMUM RATINGS

$T_c=25^{\circ}C$ unless otherwise specified

Symbol	Parameter	Test Conditions	Values	Unit
IGBT				
V_{CES}	Collector - Emitter Voltage	$T_{vj}=25^{\circ}C$	1200	V
V_{GES}	Gate - Emitter Voltage		± 20	V
I_c	DC Collector Current	$T_c=25^{\circ}C$	200	A
		$T_c=80^{\circ}C$	150	A
I_{CM}	Repetitive Peak Collector Current	$t_p=1ms$	300	A
P_{tot}	Power Dissipation Per IGBT		830	W
Diode				
V_{RRM}	Repetitive Reverse Voltage	$T_{vj}=25^{\circ}C$	1200	V
$I_{F(AV)}$	Average Forward Current	$T_c=25^{\circ}C$	200	A
		$T_c=80^{\circ}C$	150	A
I_{FRM}	Repetitive Peak Forward Current	$t_p=1ms$	300	A
I^2t		$T_{vj} = 125^{\circ}C, t=10ms, V_R=0V$	4550	A^2s

MMG150Q120B6HN

ELECTRICAL AND THERMAL CHARACTERISTICS $T_c=25^\circ\text{C}$ unless otherwise specified

Symbol	Parameter	Test Conditions	Min.	Typ.	Max.	Unit
IGBT						
$V_{GE(th)}$	Gate - Emitter Threshold Voltage	$V_{CE}=V_{GE}, I_C=6.0\text{mA}$	5.4	6	6.5	V
$V_{CE(sat)}$	Collector - Emitter Saturation Voltage	$I_C=150\text{A}, V_{GE}=15\text{V}, T_{Vj}=25^\circ\text{C}$		2.1	2.5	V
		$I_C=150\text{A}, V_{GE}=15\text{V}, T_{Vj}=125^\circ\text{C}$		2.5		V
I_{CES}	Collector Leakage Current	$V_{CE}=1200\text{V}, V_{GE}=0\text{V}, T_{Vj}=25^\circ\text{C}$			2	mA
		$V_{CE}=1200\text{V}, V_{GE}=0\text{V}, T_{Vj}=125^\circ\text{C}$			10	mA
I_{GES}	Gate Leakage Current	$V_{CE}=0\text{V}, V_{GE} \pm 15\text{V}, T_{Vj}=125^\circ\text{C}$	-400		400	nA
R_{Gint}	Integrated Gate Resistor			5		Ω
Q_g	Gate Charge	$V_{CE}=600\text{V}, I_C=150\text{A}, V_{GE}=15\text{V}$		0.70		μC
C_{ies}	Input Capacitance	$V_{CE}=25\text{V}, V_{GE}=0\text{V}, f=1\text{MHz}$		8.8		nF
C_{res}	Reverse Transfer Capacitance				0.48	
$t_{d(on)}$	Turn - on Delay Time	$V_{CC}=600\text{V}, I_C=150\text{A}, R_G=5\ \Omega, V_{GE}=\pm 15\text{V},$ Inductive Load	$T_{Vj}=25^\circ\text{C}$	160		ns
			$T_{Vj}=125^\circ\text{C}$	170		ns
			$T_{Vj}=150^\circ\text{C}$	180		ns
t_r	Rise Time		$T_{Vj}=25^\circ\text{C}$	70		ns
			$T_{Vj}=125^\circ\text{C}$	80		ns
			$T_{Vj}=150^\circ\text{C}$	85		ns
$t_{d(off)}$	Turn - off Delay Time	$V_{CC}=600\text{V}, I_C=150\text{A}, R_G=5\ \Omega, V_{GE}=\pm 15\text{V},$ Inductive Load	$T_{Vj}=25^\circ\text{C}$	420		ns
			$T_{Vj}=125^\circ\text{C}$	470		ns
			$T_{Vj}=150^\circ\text{C}$	500		ns
t_f	Fall Time		$T_{Vj}=25^\circ\text{C}$	40		ns
			$T_{Vj}=125^\circ\text{C}$	60		ns
			$T_{Vj}=150^\circ\text{C}$	70		ns
E_{on}	Turn - on Energy	$V_{CC}=600\text{V}, I_C=150\text{A}, R_G=5\ \Omega, V_{GE}=\pm 15\text{V},$ Inductive Load	$T_{Vj}=125^\circ\text{C}$	22		mJ
			$T_{Vj}=150^\circ\text{C}$	24		mJ
E_{off}	Turn - off Energy		$T_{Vj}=125^\circ\text{C}$	9		mJ
			$T_{Vj}=150^\circ\text{C}$	9.6		mJ
I_{sc}	Short Circuit Current	$t_{psc} \leq 10\ \mu\text{s}, V_{GE}=15\text{V}$ $T_{Vj}=125^\circ\text{C}, V_{CC}=600\text{V}$		600		A
R_{thJC}	Junction-to-Case Thermal Resistance (Per IGBT)				0.18	K/W
Diode						
V_F	Forward Voltage	$I_F=150\text{A}, V_{GE}=0\text{V}, T_{Vj}=25^\circ\text{C}$		1.65		V
		$I_F=150\text{A}, V_{GE}=0\text{V}, T_{Vj}=125^\circ\text{C}$		1.65		V
t_{rr}	Reverse Recovery Time	$I_F=150\text{A}, V_R=600\text{V}$		350		ns
I_{RRM}	Max. Reverse Recovery Current	$di_F/dt=-3000\text{A}/\mu\text{s}$		160		A
E_{rec}	Reverse Recovery Energy	$T_{Vj}=125^\circ\text{C}$		11.5		mJ
R_{thJCD}	Junction-to-Case Thermal Resistance (Per Diode)				0.32	K/W

MODULE CHARACTERISTICS

$T_C=25^\circ\text{C}$ unless otherwise specified

Symbol	Parameter	Test Conditions	Min.	Typ.	Max.	Unit
$T_{Vj\ max}$	Max. Junction Temperature				175	$^\circ\text{C}$
$T_{Vj\ op}$	Operating Temperature		-40		150	$^\circ\text{C}$
T_{stg}	Storage Temperature		-40		125	$^\circ\text{C}$
V_{isol}	Insulation Test Voltage	AC, t=1min		3000		V
CTI	Comparative Tracking Index		350			
Torque	Module-to-Sink	Recommended (M6)	3		5	N · m
Torque	Module Electrodes	Recommended (M6)	2.5		5	N · m
Weight				200		g

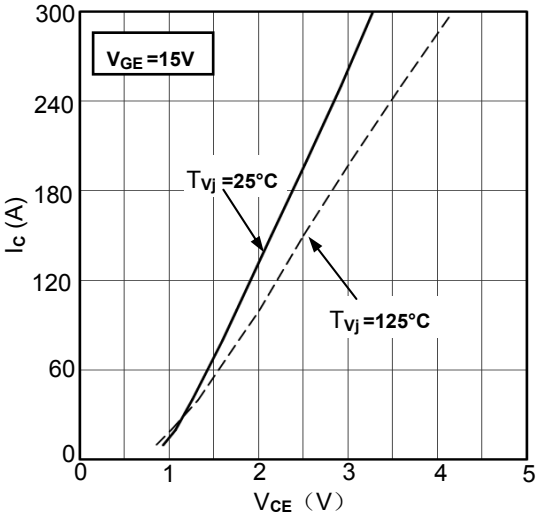

Figure1. Typical Output Characteristics

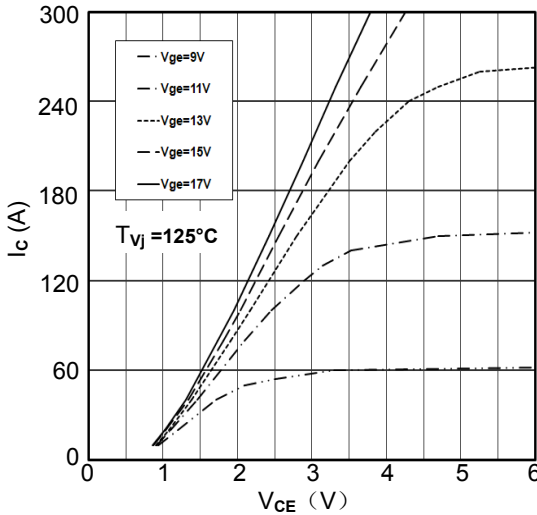

Figure2. Typical Output Characteristics

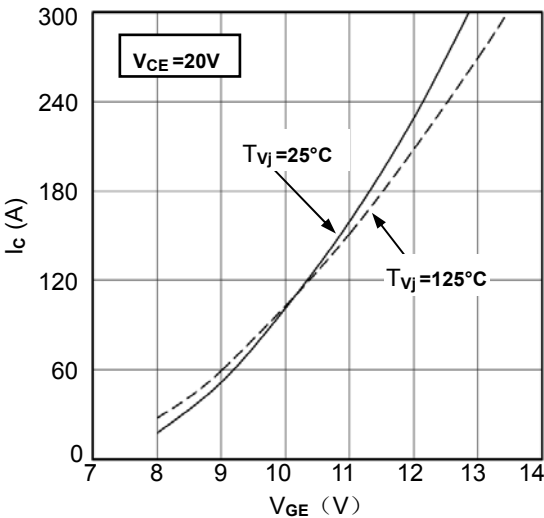

Figure3. Typical Transfer characteristics

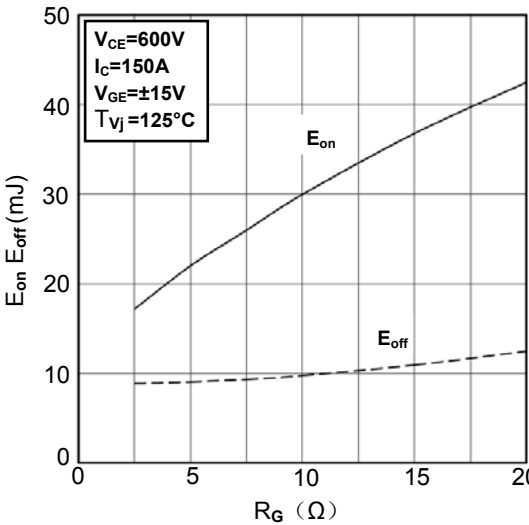

Figure4. Switching Energy vs. Gate Resistor

MMG150Q120B6HN

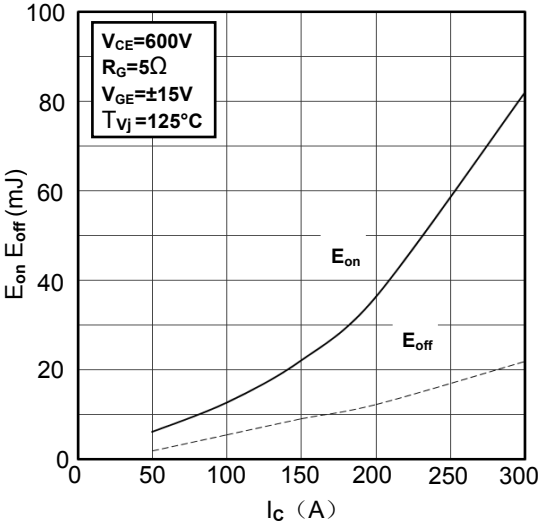

Figure5. Switching Energy vs. Collector Current

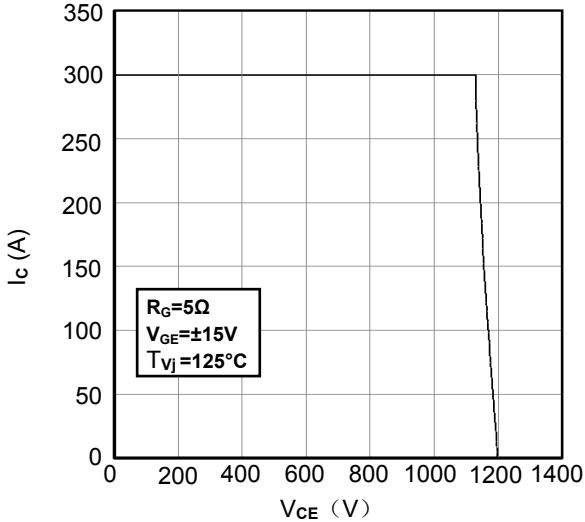

Figure6. Reverse Biased Safe Operating Area

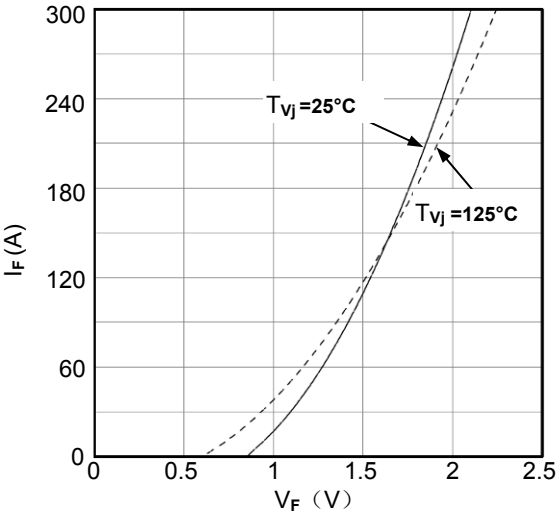

Figure7. Diode Forward Characteristics

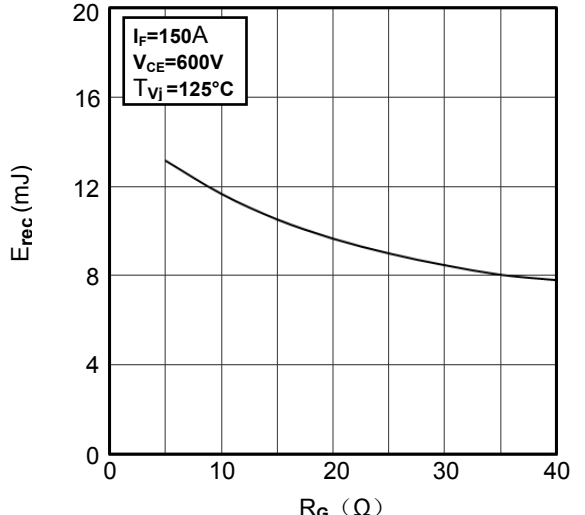

Figure8. Switching Energy vs. Gate Resistor

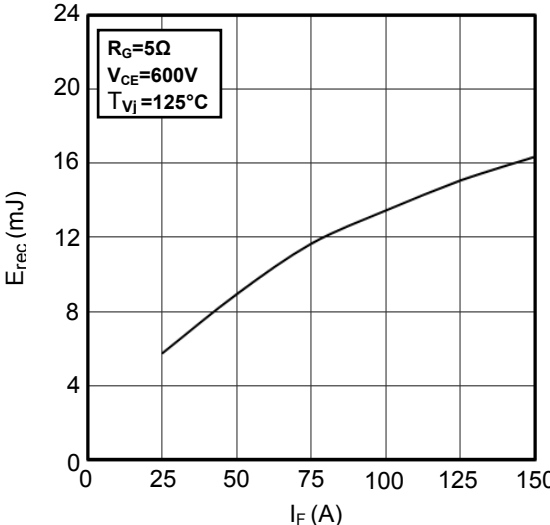

Figure9. Switching Energy vs. Forward Current

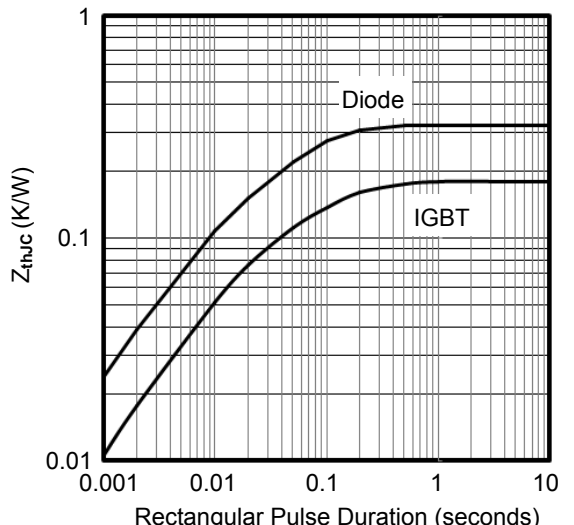

Figure10. Transient Thermal Impedance

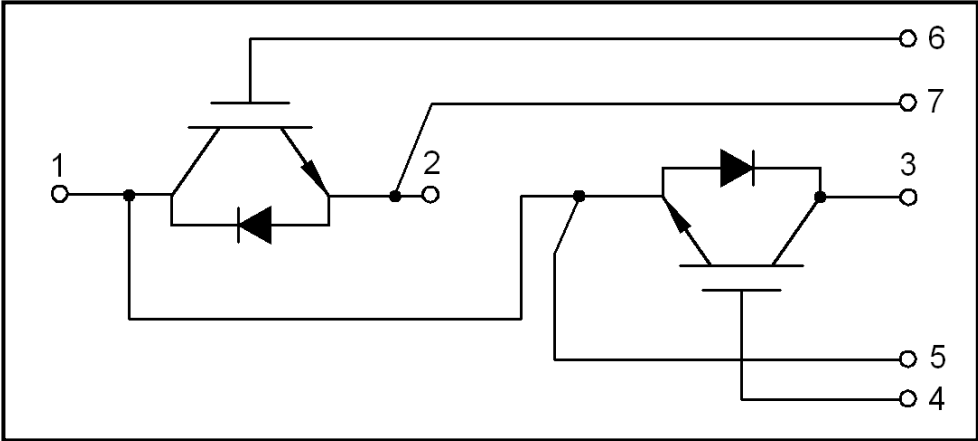
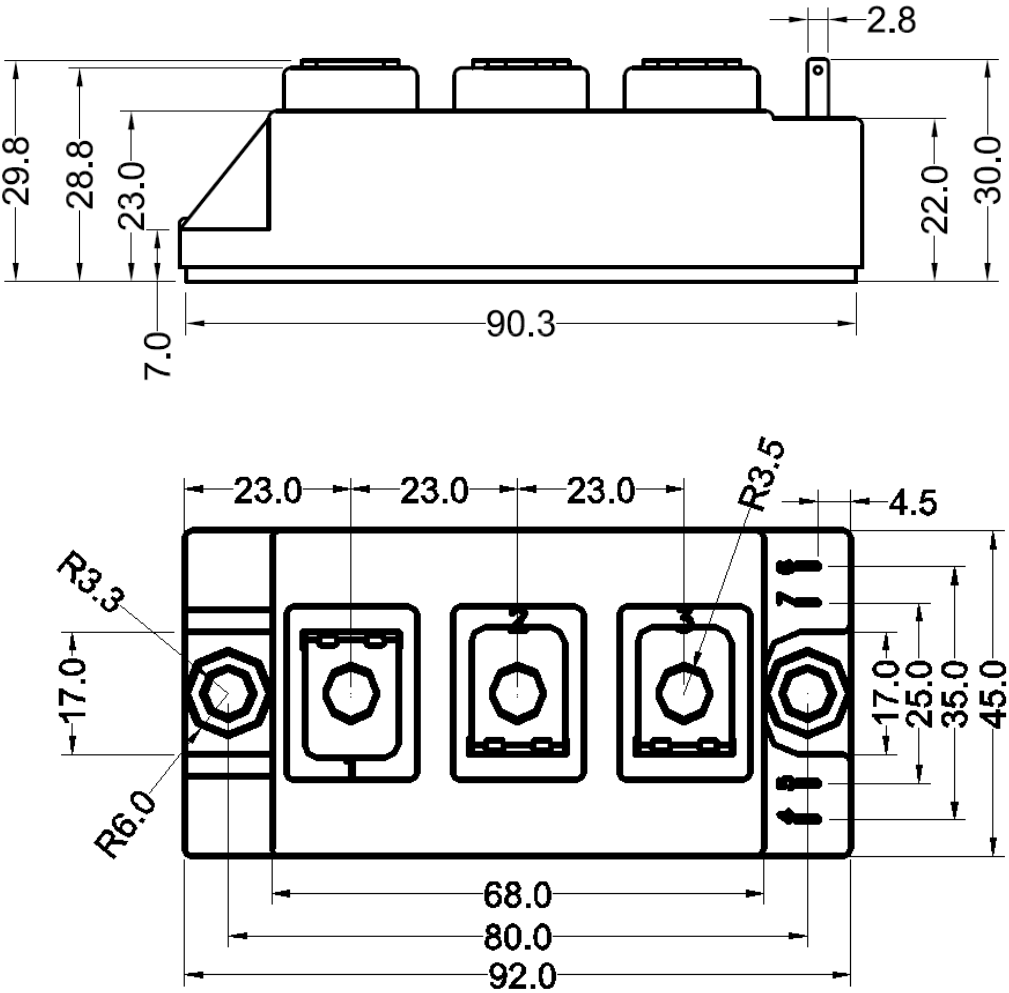

Figure11. Circuit Diagram



Dimensions (mm)
Figure12. Package Outline