

## FEATURES

- Ultra Low Loss
- High Ruggedness
- High Short Circuit Capability
- Positive Temperature Coefficient
- With Fast Free-Wheeling Diodes

## APPLICATIONS

- Invector
- Converter
- Welder
- SMPS and UPS
- Induction Heating



## ABSOLUTE MAXIMUM RATINGS

$T_C=25^{\circ}\text{C}$  unless otherwise specified

| Symbol                     | Parameter                   | Test Conditions                                       | Values      | Unit               |
|----------------------------|-----------------------------|---|-------------|--------------------|
| <b>IGBT</b>                |                             |   |             |                    |
| $V_{CES}$                  | Collector - Emitter Voltage |   | 1200        | V                  |
| $V_{GES}$                  | Gate - Emitter Voltage      |   | $\pm 20$    | V                  |
| $I_C$                      | DC Collector Current        | $T_C=25^{\circ}\text{C}$                              | 150         | A                  |
|                            |                             | $T_C=80^{\circ}\text{C}$                              | 105         | A                  |
| $I_{Cpuls}$                | Pulsed Collector Current    | $T_C=25^{\circ}\text{C}, t_p=1\text{ms}$              | 300         | A                  |
|                            |                             | $T_C=80^{\circ}\text{C}, t_p=1\text{ms}$              | 210         | A                  |
| $P_{tot}$                  | Power Dissipation Per IGBT  |   | 690         | W                  |
| $T_J$                      | Junction Temperature Range  |   | -40 to +150 | $^{\circ}\text{C}$ |
| $T_{STG}$                  | Storage Temperature Range   |   | -40 to +125 | $^{\circ}\text{C}$ |
| $V_{isol}$                 | Insulation Test Voltage     | AC, $t=1\text{min}$                                   | 3000        | V                  |
| <b>Free-Wheeling Diode</b> |                             |   |             |                    |
| $V_{RRM}$                  | Repetitive Reverse Voltage  |   | 1200        | V                  |
| $I_{F(AV)}$                | Average Forward Current     | $T_C=25^{\circ}\text{C}$                              | 125         | A                  |
|                            |                             | $T_C=80^{\circ}\text{C}$                              | 85          | A                  |
| $I_{F(RMS)}$               | RMS Forward Current         |   | 122         | A                  |
| $I_{FSM}$                  | Non-Repetitive Surge        | $T_J=45^{\circ}\text{C}, t=10\text{ms}, \text{Sine}$  | 930         | A                  |
|                            | Forward Current             | $T_J=45^{\circ}\text{C}, t=8.3\text{ms}, \text{Sine}$ | 980         | A                  |

## MMG100SR120B

### ELECTRICAL CHARACTERISTICS

$T_C=25^{\circ}\text{C}$  unless otherwise specified

| Symbol                     | Parameter                              | Test Conditions  | Min. | Typ. | Max. | Unit          |
|----------------------------|--|--|------|------|------|---------------|
| <b>IGBT</b>                |  |  |      |      |      |               |
| $V_{GE(th)}$               | Gate - Emitter Threshold Voltage       | $V_{CE}=V_{GE}, I_C=4\text{mA}$                                  | 5    | 6.2  | 7    | V             |
| $V_{CE(sat)}$              | Collector - Emitter Saturation Voltage | $I_C=100\text{A}, V_{GE}=15\text{V}, T_J=25^{\circ}\text{C}$     |      | 1.8  |      | V             |
|                            |  | $I_C=100\text{A}, V_{GE}=15\text{V}, T_J=125^{\circ}\text{C}$    |      | 2.0  |      | V             |
| $I_{CES}$                  | Collector Leakage Current              | $V_{CE}=1200\text{V}, V_{GE}=0\text{V}, T_J=25^{\circ}\text{C}$  |      | 0.2  | 0.5  | mA            |
|                            |  | $V_{CE}=1200\text{V}, V_{GE}=0\text{V}, T_J=125^{\circ}\text{C}$ |      | 3    |      | mA            |
| $I_{GES}$                  | Gate Leakage Current                   | $V_{CE}=0\text{V}, V_{GE}=\pm 20\text{V}$                        | -200 |      | 200  | nA            |
| $Q_{ge}$                   | Gate Charge                            | $V_{CC}=600\text{V}, I_C=100\text{A}, V_{GE}=\pm 15\text{V}$     |      | 1050 |      | nC            |
| $C_{ies}$                  | Input Capacitance                      | $V_{CE}=25\text{V}, V_{GE}=0\text{V}, f=1\text{MHz}$             |      | 7.43 |      | nF            |
| $C_{oes}$                  | Output Capacitance                     |  |      | 0.52 |      | nF            |
| $C_{res}$                  | Reverse Transfer Capacitance           |  |      | 0.34 |      | nF            |
| $t_{d(on)}$                | Turn - on Delay Time                   | $V_{CC}=600\text{V}, I_C=100\text{A}$                            |      | 125  |      | ns            |
| $t_r$                      | Rise Time                              | $R_G = 10\ \Omega, V_{GE}=\pm 15\text{V}$                        |      | 60   |      | ns            |
| $t_{d(off)}$               | Turn - off Delay Time                  | $T_J=25^{\circ}\text{C}$   |      | 420  |      | ns            |
| $t_f$                      | Fall Time                              | Inductive Load   |      | 60   |      | ns            |
| $t_{d(on)}$                | Turn - on Delay Time                   | $V_{CC}=600\text{V}, I_C=100\text{A}$                            |      | 135  |      | ns            |
| $t_r$                      | Rise Time                              | $R_G = 10\ \Omega, V_{GE}=\pm 15\text{V}$                        |      | 60   |      | ns            |
| $t_{d(off)}$               | Turn - off Delay Time                  | $T_J=125^{\circ}\text{C}$  |      | 490  |      | ns            |
| $t_f$                      | Fall Time                              | Inductive Load   |      | 75   |      | ns            |
| $E_{on}$                   | Turn - on Switching Energy             | $V_{CC}=600\text{V}, I_C=100\text{A}$ $T_J=25^{\circ}\text{C}$   |      | 8.6  |      | mJ            |
|                            |  | $R_G = 10\ \Omega$ $T_J=125^{\circ}\text{C}$                     |      | 12.4 |      | mJ            |
| $E_{off}$                  | Turn - off Switching Energy            | $V_{GE}=\pm 15\text{V}$ $T_J=25^{\circ}\text{C}$                 |      | 6.8  |      | mJ            |
|                            |  | Inductive Load $T_J=125^{\circ}\text{C}$                         |      | 10.8 |      | mJ            |
| <b>Free-Wheeling Diode</b> |  |  |      |      |      |               |
| $V_F$                      | Forward Voltage                        | $I_F=100\text{A}, V_{GE}=0\text{V}, T_J=25^{\circ}\text{C}$      |      | 2.0  | 2.44 | V             |
|                            |  | $I_F=100\text{A}, V_{GE}=0\text{V}, T_J=125^{\circ}\text{C}$     |      | 1.7  | 2.20 | V             |
| $t_{rr}$                   | Reverse Recovery Time                  | $I_F=100\text{A}, V_R=800\text{V}$                               |      | 220  |      | ns            |
| $I_{RRM}$                  | Max. Reverse Recovery Current          | $di_F/dt=-1000\text{A}/\mu\text{s}$                              |      | 85   |      | A             |
| $Q_{rr}$                   | Reverse Recovery Charge                | $T_J=125^{\circ}\text{C}$  |      | 9.8  |      | $\mu\text{C}$ |

### THERMAL AND MECHANICAL CHARACTERISTICS

| Symbol      | Parameter                           | Test Conditions   | Min. | Typ. | Max. | Unit  |
|-------------|-------------------------------------|-------------------|------|------|------|-------|
| $R_{thJC}$  | Junction-to-Case Thermal Resistance | Per IGBT          |      |      | 0.18 | K /W  |
| $R_{thJCD}$ | Junction-to-Case Thermal Resistance | Per Inverse Diode |      |      | 0.45 | K /W  |
| Torque      | Module-to-Sink                      | Recommended (M6)  | 3    |      | 5    | N · m |
| Torque      | Module Electrodes                   | Recommended (M5)  | 2.5  |      | 5    | N · m |
| Weight      |                                     |                   |      | 150  |      | g     |

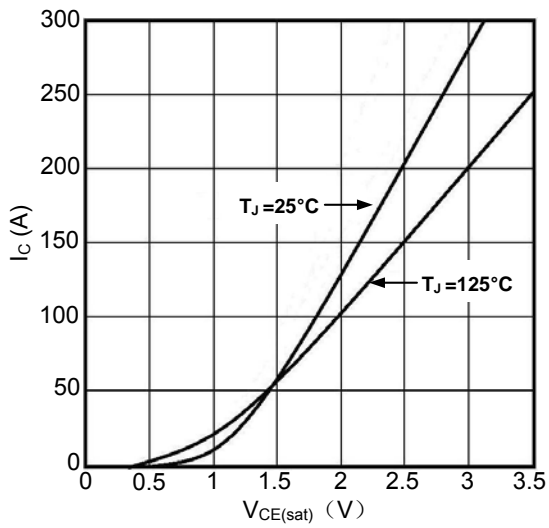

Figure1. Typical Output characteristics

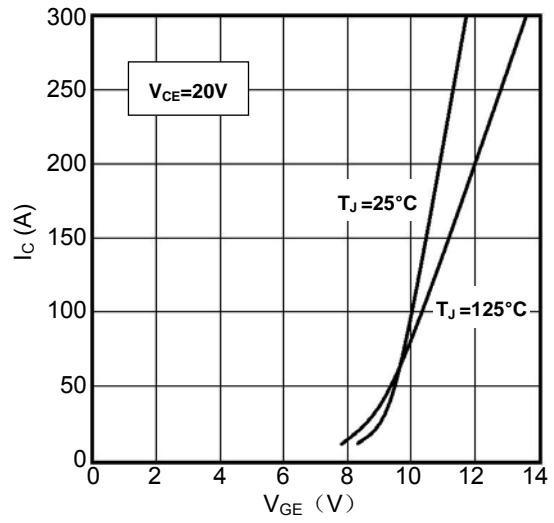

Figure2. Typical Transfer characteristics

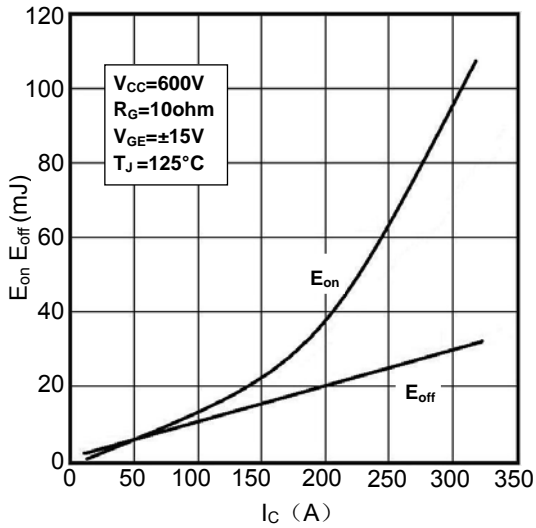

Figure3. Switching Energy vs. Collector Current

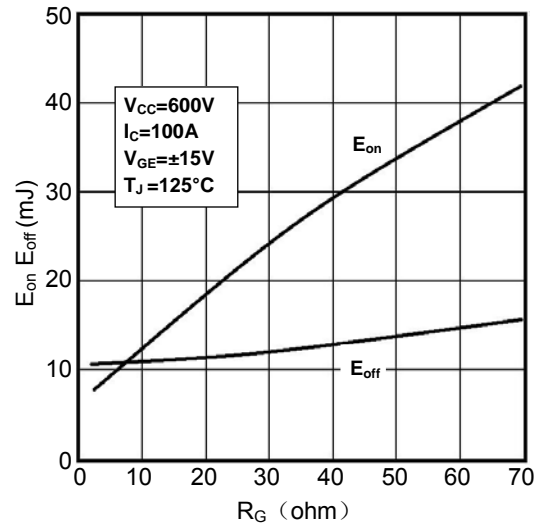

Figure4. Switching Energy vs. Gate Resistor

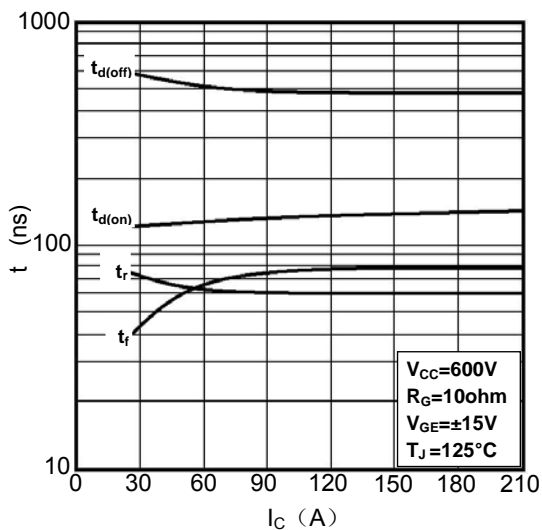

Figure5. Switching Times vs. Collector Current

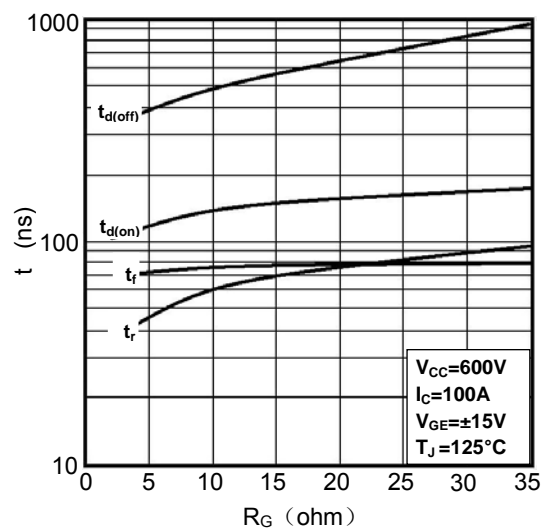

Figure6. Switching Times vs. Gate Resistor

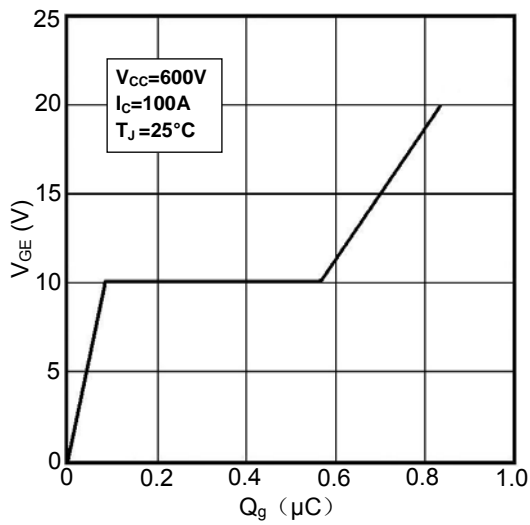

Figure7. Gate Charge characteristics

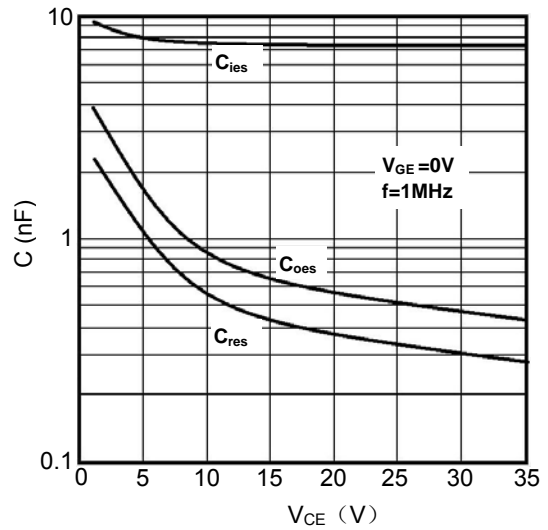

Figure8. Typical Capacitances vs.  $V_{CE}$

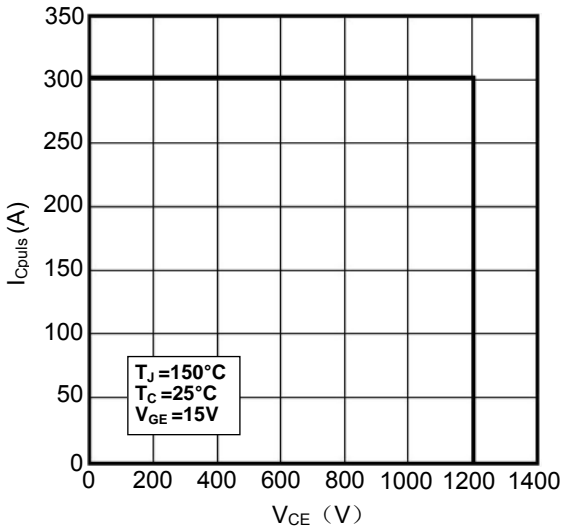

Figure9. Reverse Biased Safe Operating Area

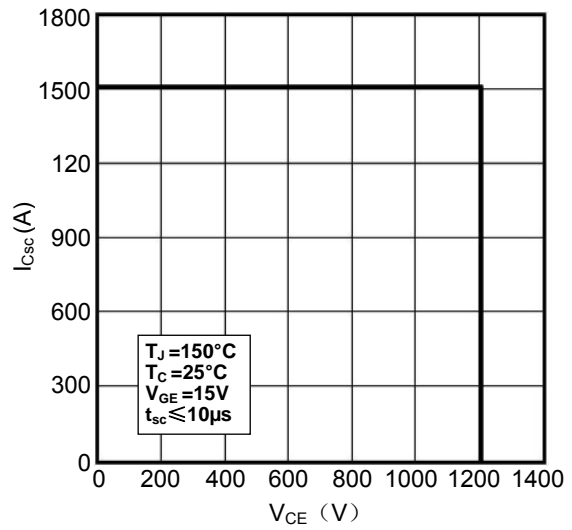

Figure10. Short Circuit Safe Operating Area

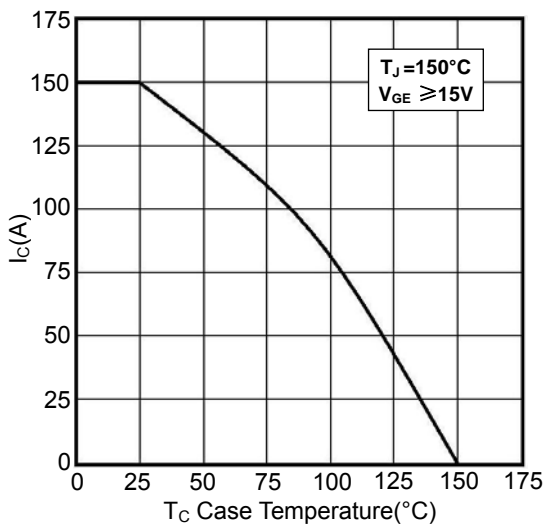

Figure11. Rated Current vs.  $T_C$

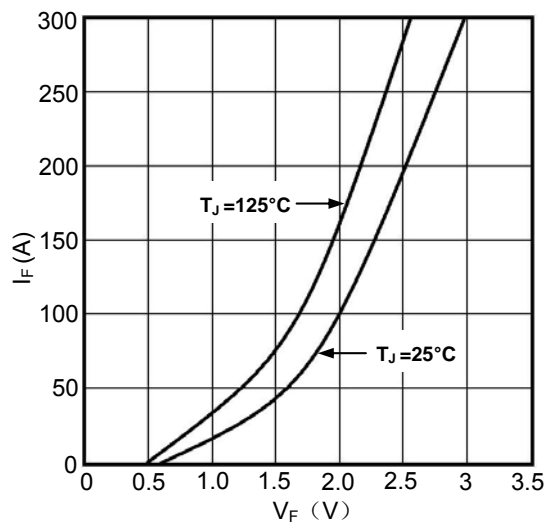
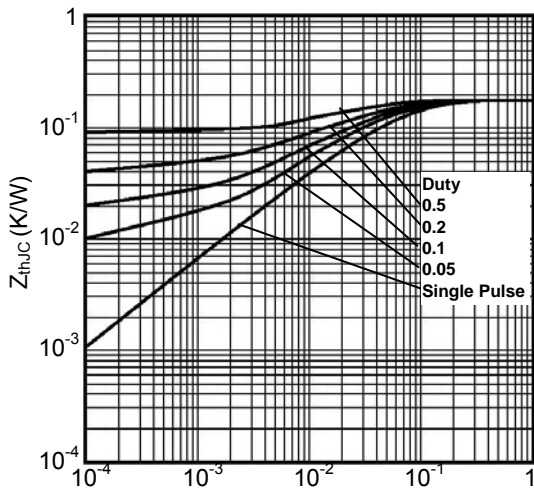
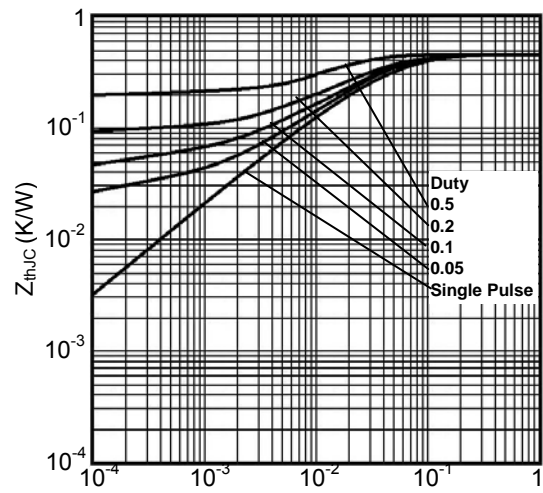

Figure12. Diode Forward Characteristics



Rectangular Pulse Duration (seconds)  
Figure13. Transient Thermal Impedance of IGBT



Rectangular Pulse Duration (seconds)  
Figure14. Transient Thermal Impedance of Diode

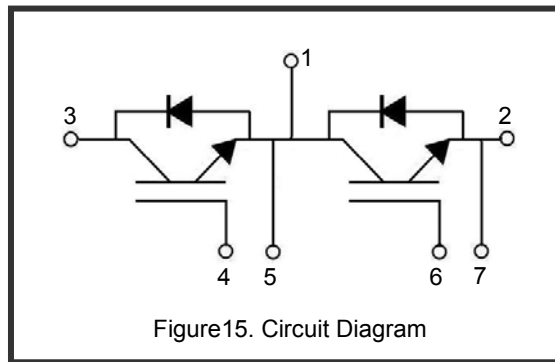

Figure15. Circuit Diagram

