

## PRODUCT FEATURES

- Ultrafast Reverse Recovery Time
- Soft Reverse Recovery Characteristics
- Low Reverse Recovery Loss
- Low Forward Voltage
- High Surge Current Capability
- Low Inductance Package



## APPLICATIONS

- Inversion Welder
- Uninterruptible Power Supply (UPS)
- Plating Power Supply
- Ultrasonic Cleaner and Welder
- Converter & Chopper
- Power Factor Correction (PFC) Circuit

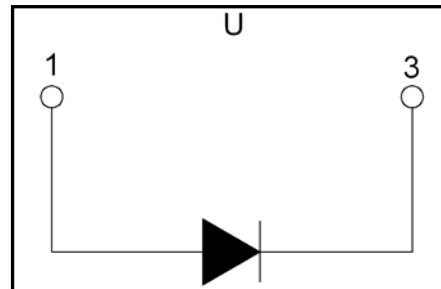

## ABSOLUTE MAXIMUM RATINGS

 $T_C=25^{\circ}\text{C}$  unless otherwise specified

| Symbol          | Parameter                            | Test Conditions  | Values      | Unit                        |
|-----------------|--------------------------------------|--|-------------|-----------------------------|
| $V_R$           | Maximum D.C. Reverse Voltage         |  | 1200        | V                           |
| $V_{RRM}$       | Maximum Repetitive Reverse Voltage   |  | 1200        | V                           |
| $I_{F(AV)}$     | Average Forward Current              | $T_C=100^{\circ}\text{C}$  | 600         | A                           |
|                 |                                      | $T_C=100^{\circ}\text{C}, 20\text{KHz}$                            | 420         | A                           |
| $I_{F(RMS)}$    | RMS Forward Current                  | $T_C=100^{\circ}\text{C}$  | 840         | A                           |
| $I_{FSM}$       | Non-Repetitive Surge Forward Current | $T_J=45^{\circ}\text{C}, t=10\text{ms}, 50\text{Hz}, \text{Sine}$  | 4800        | A                           |
|                 |                                      | $T_J=45^{\circ}\text{C}, t=8.3\text{ms}, 60\text{Hz}, \text{Sine}$ | 5100        | A                           |
| $I^2t$          | $I^2t$ (For Fusing)                  | $T_J=45^{\circ}\text{C}, t=10\text{ms}, 50\text{Hz}, \text{Sine}$  | 115200      | $\text{A}^2\text{s}$        |
|                 |                                      | $T_J=45^{\circ}\text{C}, t=8.3\text{ms}, 60\text{Hz}, \text{Sine}$ | 108000      | $\text{A}^2\text{s}$        |
| $P_D$           | Power Dissipation                    |  | 1250        | W                           |
| $T_J$           | Junction Temperature                 |  | -40 to +150 | $^{\circ}\text{C}$          |
| $T_{STG}$       | Storage Temperature Range            |  | -40 to +125 | $^{\circ}\text{C}$          |
| $V_{isol}$      | Insulation Test Voltage              | AC, $t=1\text{min}$  | 3000        | V                           |
| Torque          | Module-to-Sink                       | Recommended (M6)   | 3~5         | N·m                         |
| Torque          | Module Electrodes                    | Recommended (M6)   | 3~5         | N·m                         |
| $R_{\theta JC}$ | Thermal Resistance                   | Junction-to-Case   | 0.10        | $^{\circ}\text{C}/\text{W}$ |
| Weight          |                                      |  | 160         | g                           |

**ELECTRICAL CHARACTERISTICS**

$T_C=25^\circ\text{C}$  unless otherwise specified

| Symbol    | Parameter                     | Test Conditions   | Min.  | Typ. | Max. | Unit |
|-----------|-------------------------------|---|---|------|------|------|
| $I_{RM}$  | Reverse Leakage Current       | $V_R=1200\text{V}$  | --  | --   | 5    | mA   |
|           |                               | $V_R=1200\text{V}, T_J=125^\circ\text{C}$                         | --  | --   | 20   | mA   |
| $V_F$     | Forward Voltage               | $I_F=600\text{A}$   | --  | 2.8  | 3.1  | V    |
|           |                               | $I_F=600\text{A}, T_J=125^\circ\text{C}$                          | --  | 2.1  | 2.4  | V    |
| $t_{rr}$  | Reverse Recovery Time         | $I_F=1\text{A}, V_R=30\text{V}, di_F/dt=-200\text{A}/\mu\text{s}$ | --  | 80   | --   | ns   |
| $t_{rr}$  | Reverse Recovery Time         | $V_R=600\text{V}, I_F=600\text{A}$                                | --  | 200  | --   | ns   |
| $I_{RRM}$ | Max. Reverse Recovery Current |   | $di_F/dt=-200\text{A}/\mu\text{s}, T_J=25^\circ\text{C}$  | --   | 18   | --   |
| $t_{rr}$  | Reverse Recovery Time         | $V_R=600\text{V}, I_F=600\text{A}$                                | --  | 600  | --   | ns   |
| $I_{RRM}$ | Max. Reverse Recovery Current |   | $di_F/dt=-200\text{A}/\mu\text{s}, T_J=125^\circ\text{C}$ | --   | 40   | --   |

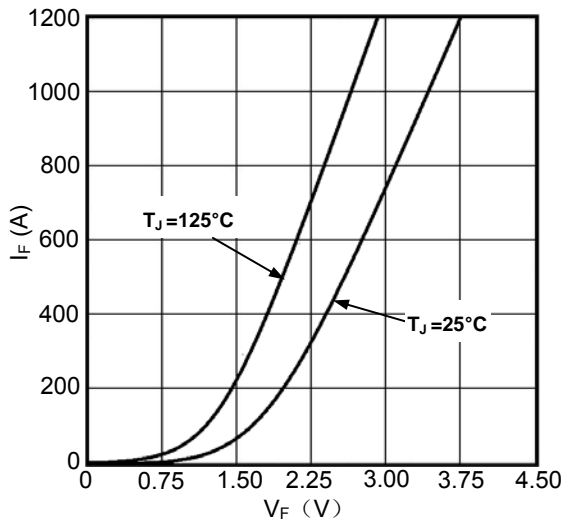

Figure1. Forward Voltage Drop vs Forward Current

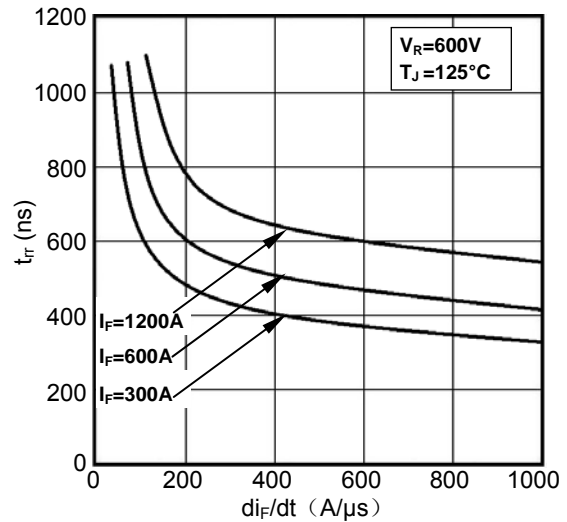

Figure2. Reverse Recovery Time vs  $di_F/dt$

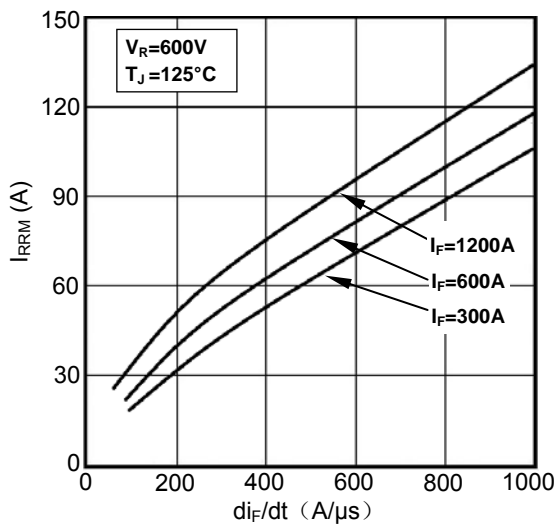

Figure3. Reverse Recovery Current vs  $di_F/dt$

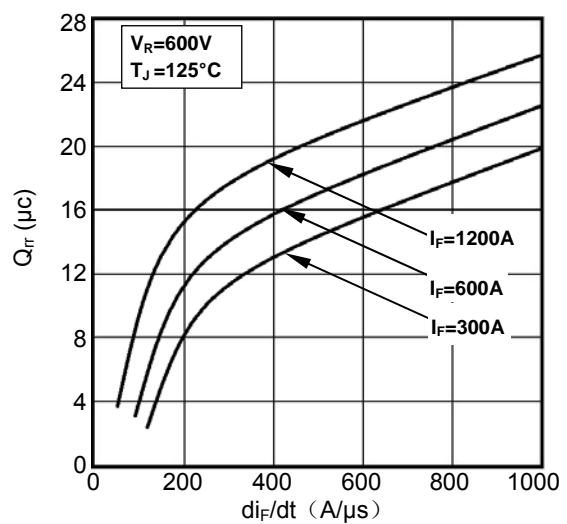

Figure4. Reverse Recovery Charge vs  $di_F/dt$

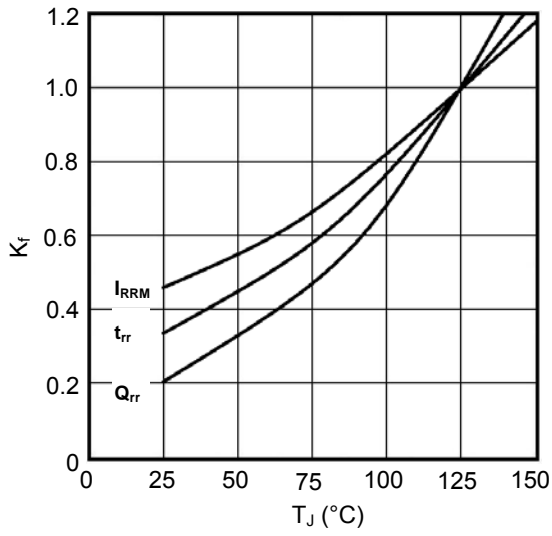

Figure5. Dynamic Parameters vs Junction Temperature

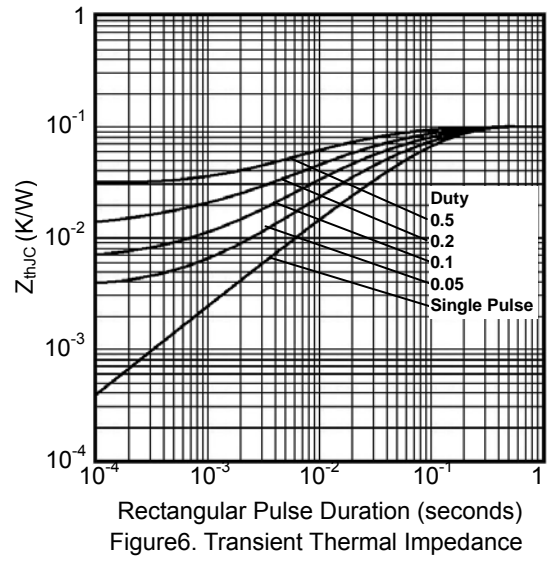
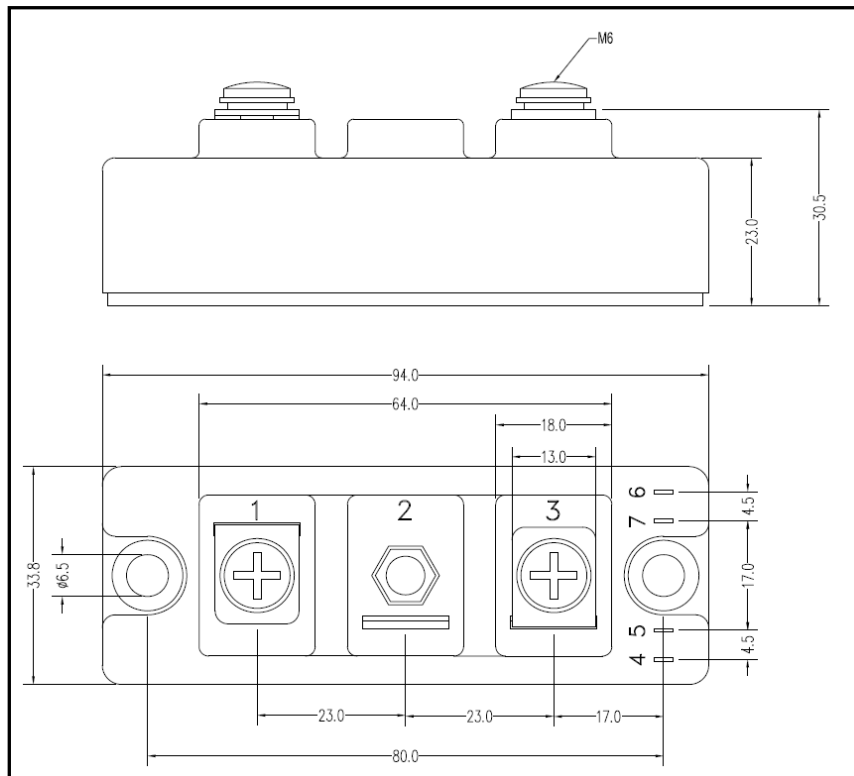

Figure6. Transient Thermal Impedance



Dimensions (mm)  
Figure7. Package Outline