

PRODUCT FEATURES

- Ultrafast Reverse Recovery Time
- Soft Reverse Recovery Characteristics
- Low Reverse Recovery Loss
- Low Forward Voltage
- High Surge Current Capability
- Low Inductance Package



APPLICATIONS

- Inversion Welder
- Uninterruptible Power Supply (UPS)
- Plating Power Supply
- Ultrasonic Cleaner and Welder
- Converter & Chopper
- Power Factor Correction (PFC) Circuit

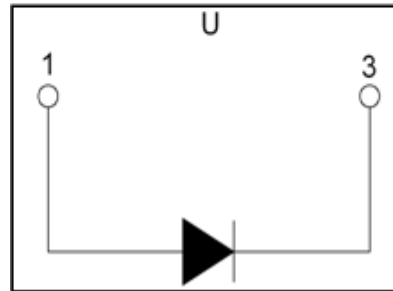

ABSOLUTE MAXIMUM RATINGS

T_C=25°C unless otherwise specified

Symbol	Parameter	Test Conditions	Values	Unit
V _R	Maximum D.C. Reverse Voltage		1200	V
V _R RM	Maximum Repetitive Reverse Voltage		1200	V
I _{F(AV)}	Average Forward Current	T _C =100°C	400	A
		T _C =110°C, 20KHz	280	A
I _{F(RMS)}	RMS Forward Current	T _C =100°C	560	A
I _{FSM}	Non-Repetitive Surge Forward Current	T _J =45°C, t=10ms, 50Hz, Sine	3200	A
		T _J =45°C, t=8.3ms, 60Hz, Sine	3500	A
I ² t	I ² t (For Fusing)	T _J =45°C, t=10ms, 50Hz, Sine	51200	A ² s
		T _J =45°C, t=8.3ms, 60Hz, Sine	61250	A ² s
P _D	Power Dissipation		1136	W
T _J	Junction Temperature		-40 to +150	°C
T _{STG}	Storage Temperature Range		-40 to +125	°C
V _{isol}	Insulation Test Voltage	AC, t=1min	3000	V
Torque	Module-to-Sink	Recommended (M6)	3~5	N·m
Torque	Module Terminal	Recommended (M6)	3~5	N·m
R _{θJC}	Thermal Resistance	Junction-to-Case	0.11	°C/W
Weight			160	g

ELECTRICAL CHARACTERISTICS

$T_C=25^\circ\text{C}$ unless otherwise specified

Symbol	Parameter	Test Conditions	Min.	Typ.	Max.	Unit
I_{RM}	Reverse Leakage Current	$V_R=1200\text{V}$	--	--	5	mA
		$V_R=1200\text{V}, T_J=125^\circ\text{C}$	--	--	20	mA
V_F	Forward Voltage	$I_F=400\text{A}$	--	3.0	--	V
		$I_F=400\text{A}, T_J=125^\circ\text{C}$	--	2.0	--	V
t_{rr}	Reverse Recovery Time	$I_F=1\text{A}, V_R=30\text{V}, di_F/dt=-200\text{A}/\mu\text{s}$	--	75	--	ns
t_{rr}	Reverse Recovery Time	$V_R=600\text{V}, I_F=400\text{A}$	--	180	--	ns
I_{RRM}	Max. Reverse Recovery Current		$di_F/dt=-200\text{A}/\mu\text{s}, T_J=25^\circ\text{C}$	--	15	--
t_{rr}	Reverse Recovery Time	$V_R=600\text{V}, I_F=400\text{A}$	--	500	--	ns
I_{RRM}	Max. Reverse Recovery Current		$di_F/dt=-200\text{A}/\mu\text{s}, T_J=125^\circ\text{C}$	--	35	--

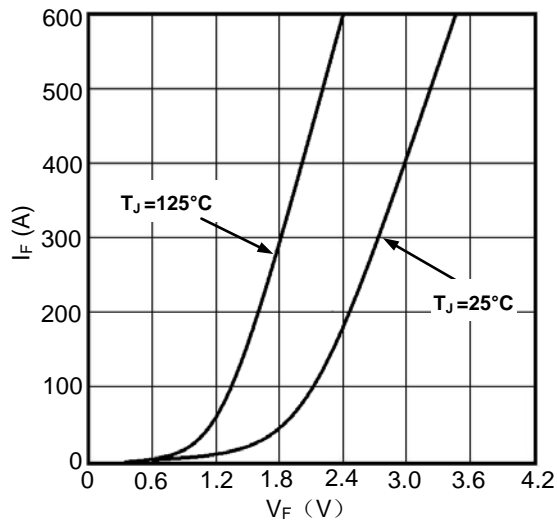

Figure1. Forward Voltage Drop vs Forward Current

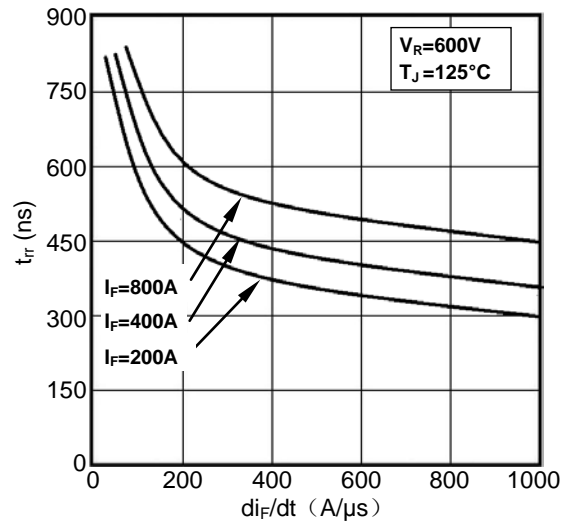

Figure2. Reverse Recovery Time vs di_F/dt

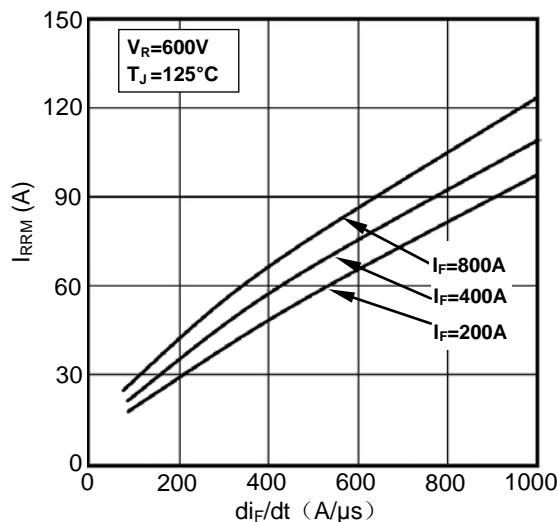

Figure3. Reverse Recovery Current vs di_F/dt

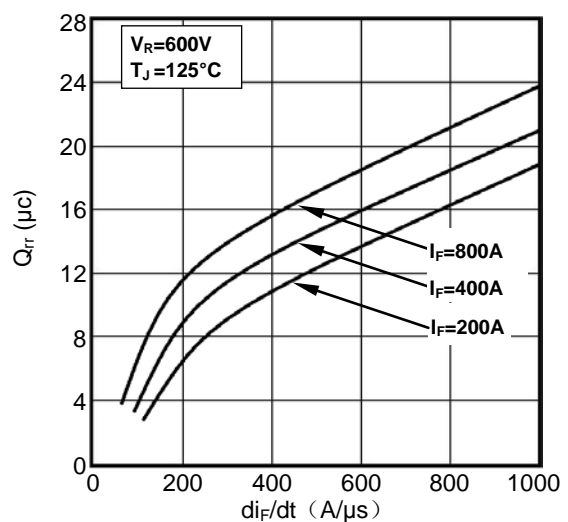

Figure4. Reverse Recovery Charge vs di_F/dt

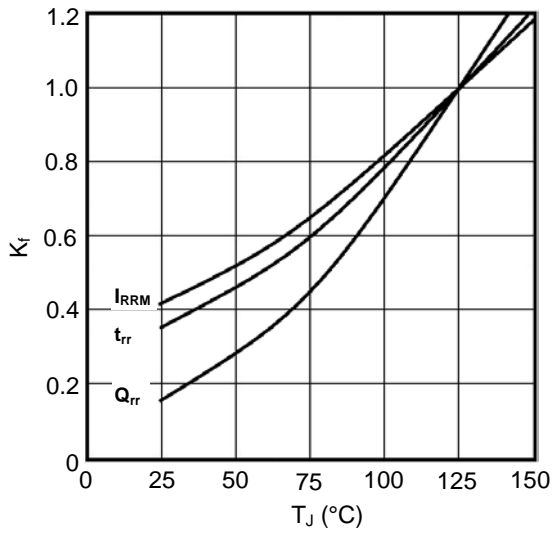

Figure5. Dynamic Parameters vs Junction Temperature

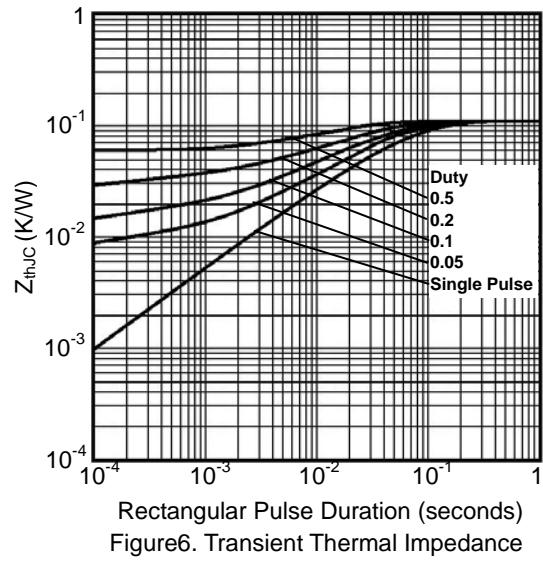
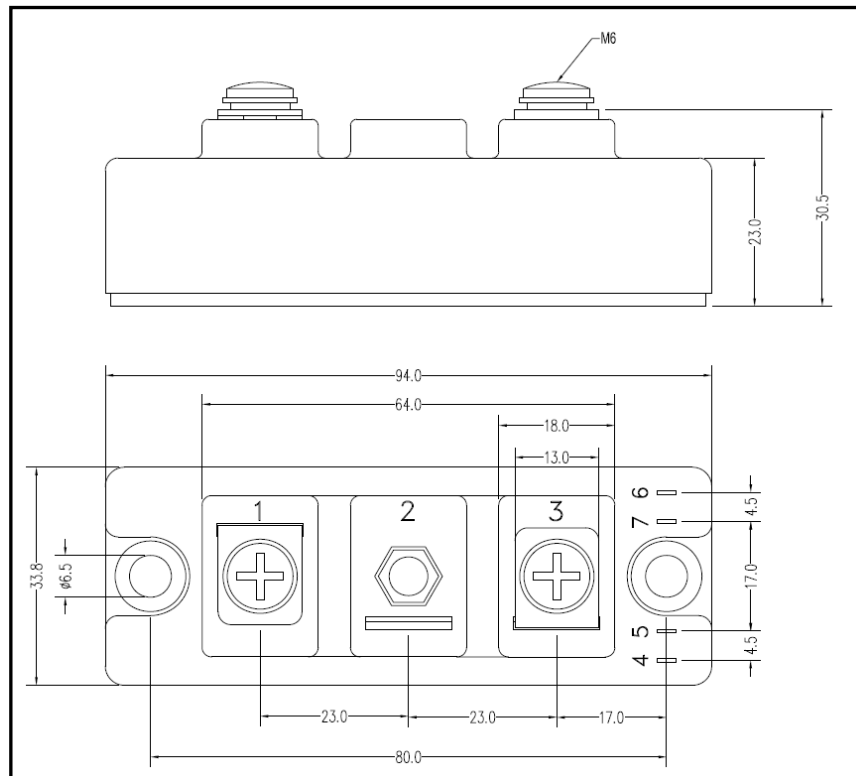

Figure6. Transient Thermal Impedance



Dimensions (mm)
Figure7. Package Outline