

## PRODUCT FEATURES

- Ultrafast Recovery Time
- Low Recovery Loss
- Low Forward Voltage
- Low Leakage Current
- Low Inductance Package



## APPLICATIONS

- Inversion Welder
- Uninterruptible Power Supply
- Plating Power Supply
- Ultrasonic Cleaner and Welder
- Converter & Chopper
- PFC

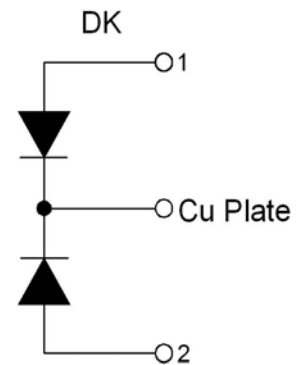

## ABSOLUTE MAXIMUM RATINGS

$T_C = 25^\circ\text{C}$  unless otherwise specified

Symbol	Parameter/Test Conditions		Values	Unit
$V_R$	Maximum D.C. Reverse Voltage		400	V
$V_{RRM}$	Maximum Repetitive Reverse Voltage			
$I_{F(AV)}$	Average Forward Current	$T_C = 110^\circ\text{C}$ , Per Diode	150	A
		$T_C = 110^\circ\text{C}$ , Per Module	300	
$I_{F(RMS)}$	RMS Forward Current	$T_C = 110^\circ\text{C}$ , Per Diode	210	
$I_{FSM}$	Non-Repetitive Surge Forward Current	1/2 Cycle, 50Hz, Sine	2000	
		1/2 Cycle, 60Hz, Sine	2100	
$I^2t$	For Fusing	$T_J = 45^\circ\text{C}$ , $t = 10\text{ms}$ , 50Hz, Sine	20000	A <sup>2</sup> S
		$T_J = 45^\circ\text{C}$ , $t = 8.3\text{ms}$ , 60Hz, Sine	18300	
$P_D$	Power Dissipation		500	W
$T_J$	Junction Temperature		-40 to +150	$^\circ\text{C}$
$T_{STG}$	Storage Temperature Range		-40 to +125	$^\circ\text{C}$
<b>Torque</b>	Module-to-Sink	Recommended (M6)	3~4.7	N.m
<b>Torque</b>	Module Electrodes	Recommended (M6)	3~4.7	N.m
$R_{th(J-C)}$	Junction-to-Case Thermal Resistance		0.25	K/W
<b>Weight</b>			92	g

**ELECTRICAL CHARACTERISTICS**

$T_C=25^{\circ}\text{C}$  unless otherwise specified

Symbol	Parameter/Test Conditions		Min.	Typ.	Max.	Unit
$I_{RM}$	Maximum Reverse Leakage Current	$V_R = 400\text{V}$			0.5	mA
		$V_R = 400\text{V}, T_J = 125^{\circ}\text{C}$			1	
$V_F$	Forward Voltage	$I_F = 150\text{A}$		1.20	1.45	V
		$I_F = 150\text{A}, T_J = 125^{\circ}\text{C}$		1.10		
$t_{rr}$	Reverse Recovery Time ( $I_F = 1\text{A}, di_F/dt = -200\text{A}/\mu\text{s}, V_R = 30\text{V}$ )			53		ns
$t_{rr}$	Reverse Recovery Time	$I_F = 150\text{A}, V_R = 200\text{V},$		95		ns
$I_{RRM}$	Maximum Reverse Recovery Current	$di_F/dt = -200\text{A}/\mu\text{s}$		12		A
$t_{rr}$	Reverse Recovery Time	$I_F = 150\text{A}, V_R = 200\text{V},$		165		ns
$I_{RRM}$	Maximum Reverse Recovery Current	$di_F/dt = -200\text{A}/\mu\text{s}, T_J = 125^{\circ}\text{C}$		20		A

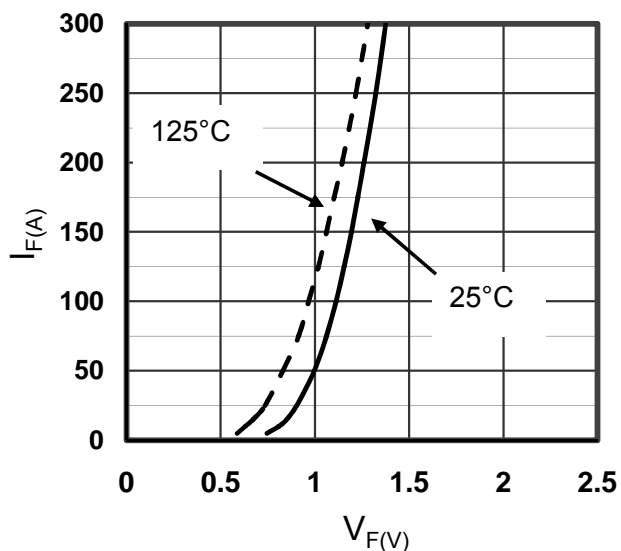

Figure1. Forward Voltage Drop vs Forward Current

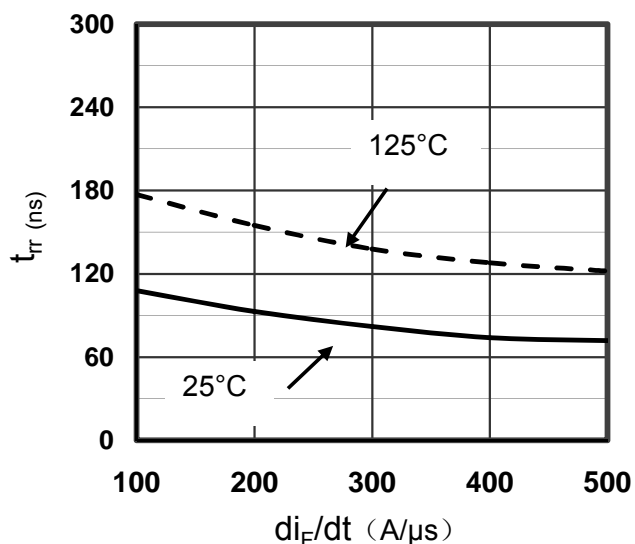

Figure2. Reverse Recovery Time vs diF/dt

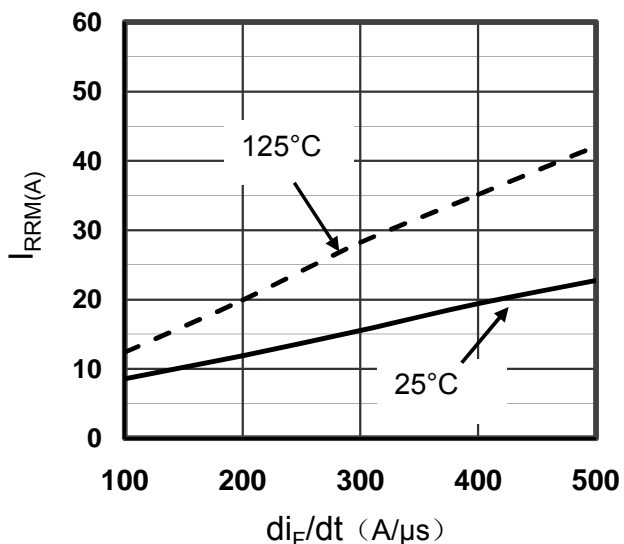

Figure3. Reverse Recovery Current vs diF/dt

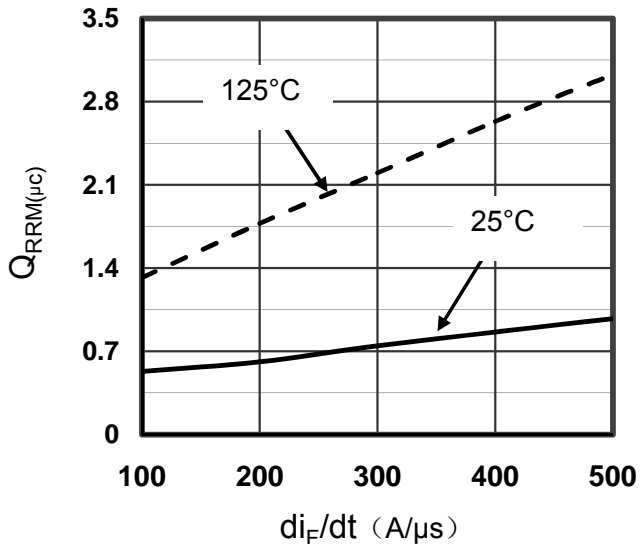

Figure4. Reverse Recovery Charge vs diF/dt

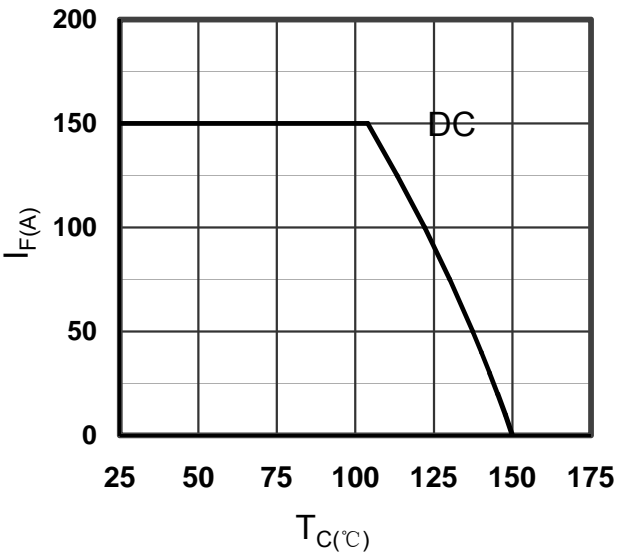

Figure5. Forward current vs. Case temperature

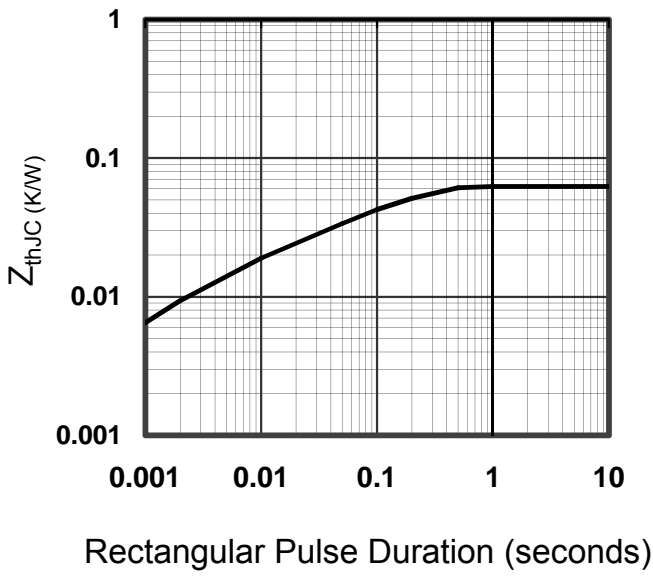
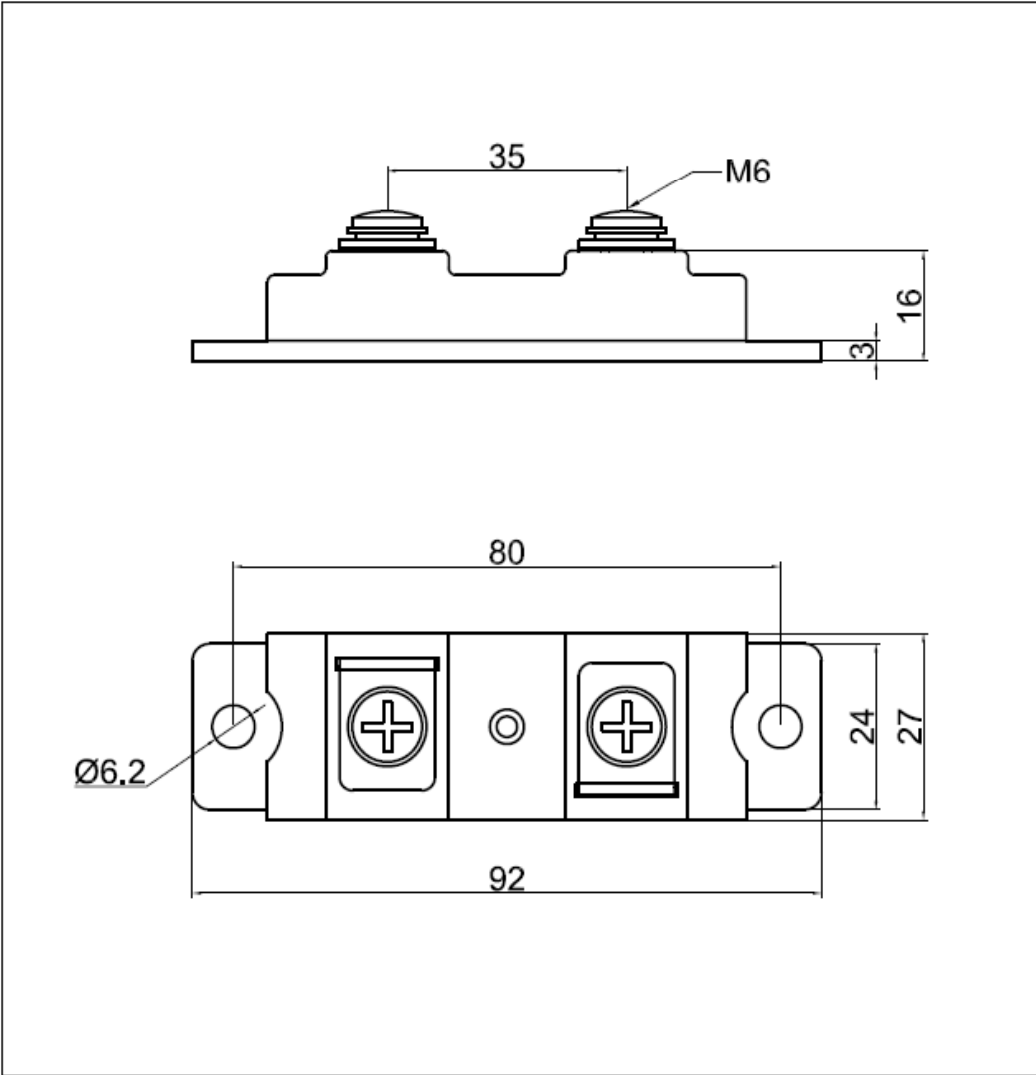

Figure6. Transient Thermal Impedance



Dimensions in Millimeters and (Inchs)  
Figure7. Package Outline