



January 2011

PRELIMINARY

# MMF250Y060DK1

600V 250A FRED Module

RoHS Compliant

## PRODUCT FEATURES

- Ultrafast Reverse Recovery Time
- Soft Reverse Recovery Characteristics
- Low Reverse Recovery Loss
- Low Forward Voltage
- High Surge Current Capability
- Low Inductance Package



## APPLICATIONS

- Inversion Welder
- Uninterruptible Power Supply (UPS)
- Plating Power Supply
- Ultrasonic Cleaner and Welder
- Converter & Chopper
- Power Factor Correction (PFC) Circuit

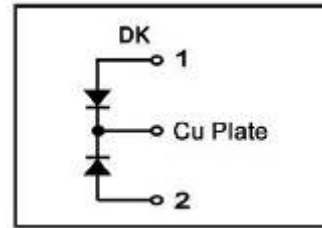

## ABSOLUTE MAXIMUM RATINGS

T<sub>C</sub>=25°C unless otherwise specified

Symbol	Parameter	Test Conditions	Values	Unit
V <sub>R</sub>	Maximum D.C. Reverse Voltage		600	V
V <sub>RRM</sub>	Maximum Repetitive Reverse Voltage		600	V
I <sub>F(AV)</sub>	Average Forward Current	T <sub>C</sub> =125°C, Per Diode	125	A
		T <sub>C</sub> =125°C, Per Moudle	250	A
		T <sub>C</sub> =125°C, 20KHz, Per Moudle	180	A
I <sub>F(RMS)</sub>	RMS Forward Current	T <sub>C</sub> =125°C, Per Diode	180	A
I <sub>FSM</sub>	Non-Repetitive Surge Forward Current	1/2 Cycle , 50Hz, Sine	2650	A
		1/2 Cycle , 60Hz, Sine	2850	A
I <sup>2</sup> t	I <sup>2</sup> t (For Fusing)	T <sub>J</sub> =45°C, t=10ms, 50Hz, Sine	35112	A <sup>2</sup> s
		T <sub>J</sub> =45°C, t=8.3ms, 60Hz, Sine	40612	A <sup>2</sup> s
P <sub>D</sub>	Power Dissipation		1670	W
T <sub>J</sub>	Junction Temperature		-40 to +150	°C
T <sub>STG</sub>	Storage Temperature Range		-40 to +125	°C
Torque	Module-to-Sink	Recommended (M6)	3~4.7	N·m
Torque	Module Terminal	Recommended (M6)	3~4.7	N·m
R <sub>θJC</sub>	Thermal Resistance	Junction-to-Case, Per Diode	0.075	°C /W
Weight			90	g

**ELECTRICAL CHARACTERISTICS**

$T_C=25^\circ\text{C}$  unless otherwise specified

Symbol	Parameter	Test Conditions	Min.	Typ.	Max.	Unit
$I_{RM}$	Reverse Leakage Current	$V_R=600\text{V}$	--	--	0.5	mA
		$V_R=600\text{V}, T_J=125^\circ\text{C}$	--	--	10	mA
$V_F$	Forward Voltage	$I_F=125\text{A}$	--	1.28	--	V
		$I_F=125\text{A}, T_J=125^\circ\text{C}$	--	1.10	--	V
$t_{rr}$	Reverse Recovery Time	$I_F=1\text{A}, V_R=30\text{V}, di_F/dt=-200\text{A}/\mu\text{s}$	--	49	--	ns
$t_{rr}$	Reverse Recovery Time	$V_R=300\text{V}, I_F=125\text{A}$	--	95	--	ns
$I_{RRM}$	Max. Reverse Recovery Current	$di_F/dt=-200\text{A}/\mu\text{s}, T_J=25^\circ\text{C}$	--	7.5	--	A
$t_{rr}$	Reverse Recovery Time	$V_R=300\text{V}, I_F=125\text{A}$	--	185	--	ns
$I_{RRM}$	Max. Reverse Recovery Current	$di_F/dt=-200\text{A}/\mu\text{s}, T_J=125^\circ\text{C}$	--	15.5	--	A

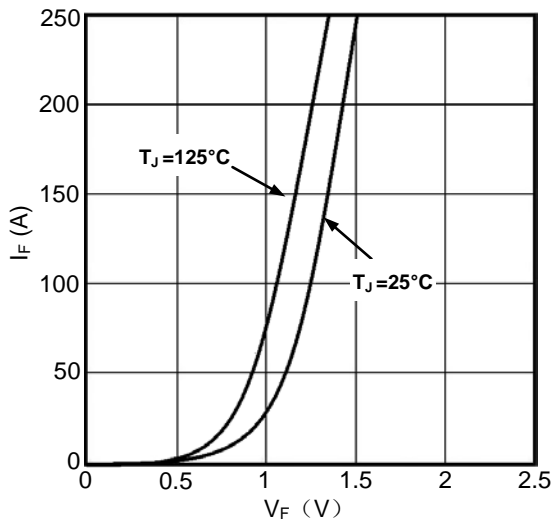

Figure1. Forward Voltage Drop vs Forward Current

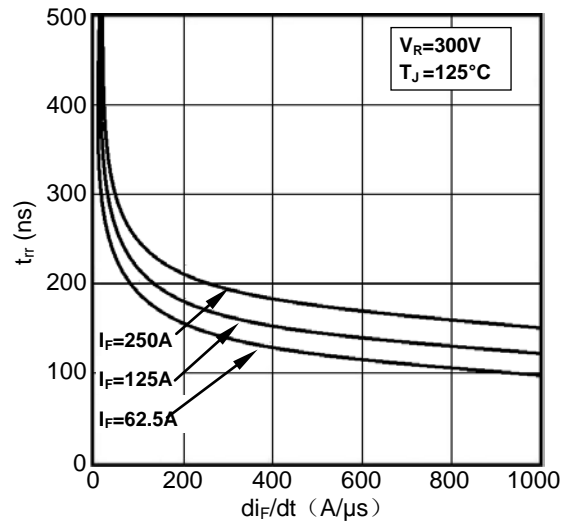

Figure2. Reverse Recovery Time vs  $di_F/dt$

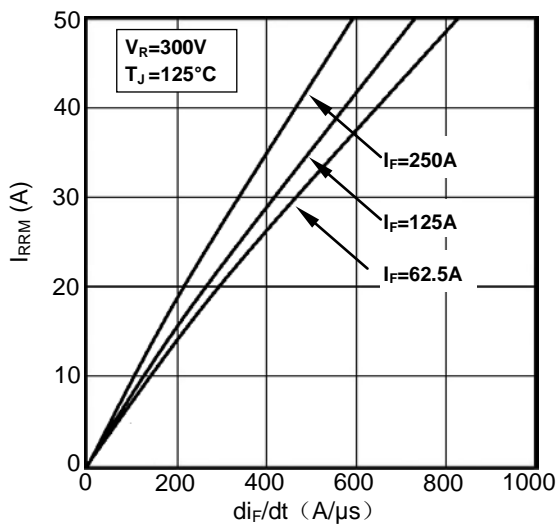

Figure3. Reverse Recovery Current vs  $di_F/dt$

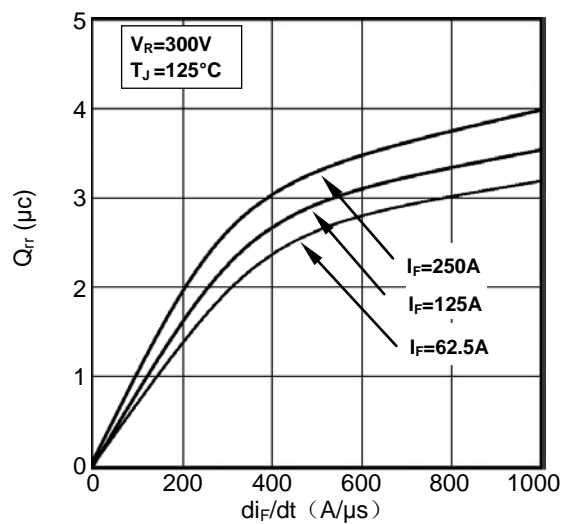

Figure4. Reverse Recovery Charge vs  $di_F/dt$

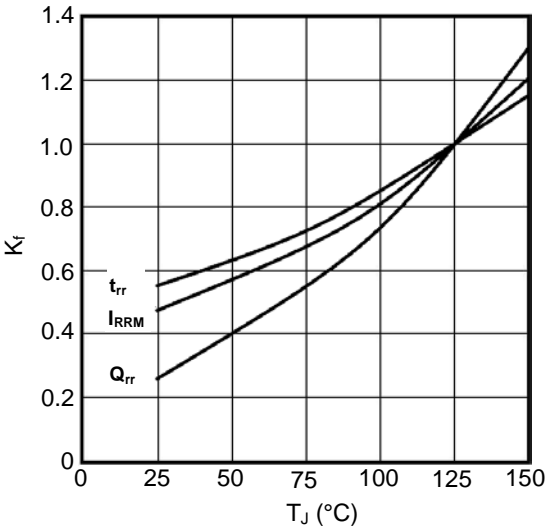

Figure5. Dynamic Parameters vs Junction Temperature

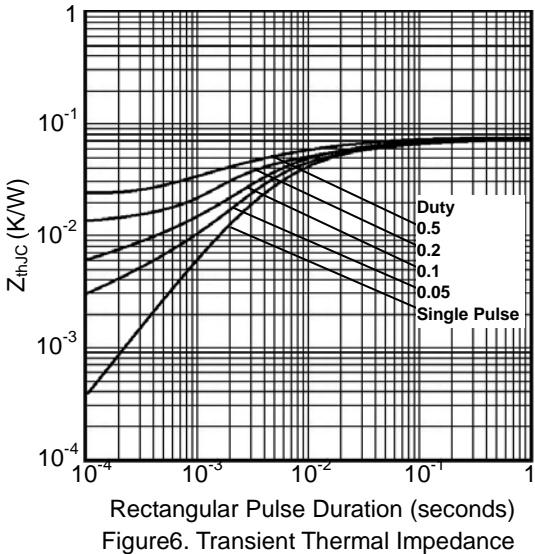
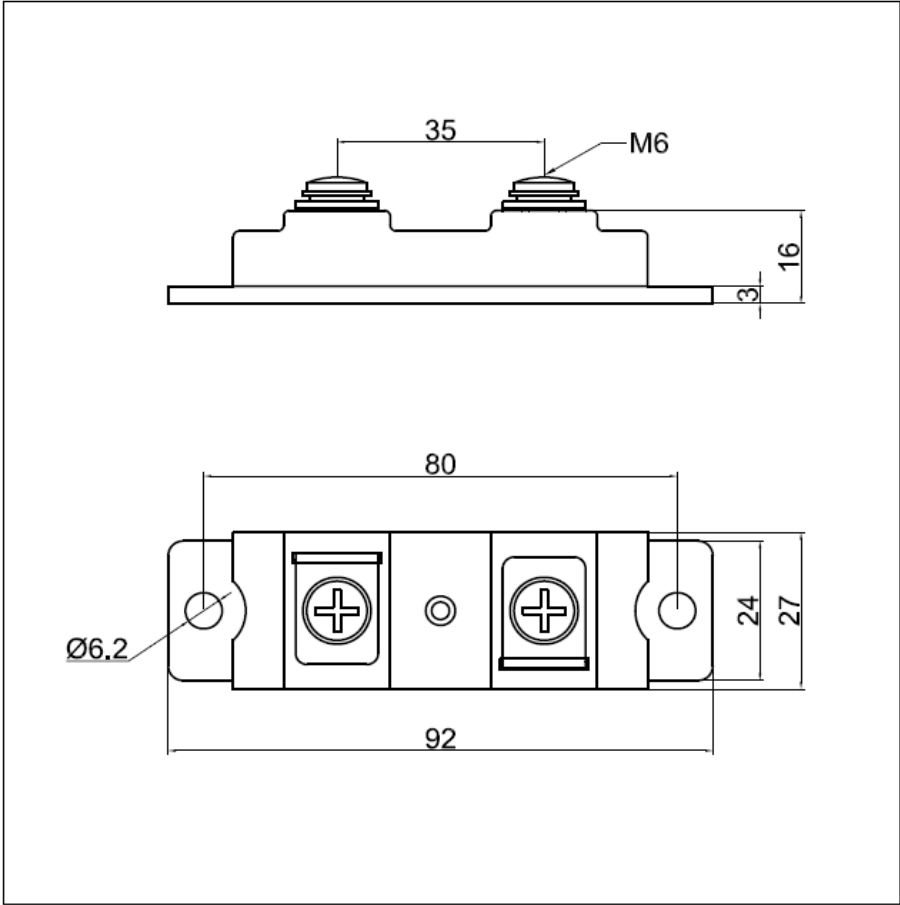

Figure6. Transient Thermal Impedance



Dimensions (mm)  
Figure7. Package Outline