

## PRODUCT FEATURES

- Ultrafast Reverse Recovery Time
- Soft Reverse Recovery Characteristics
- Low Reverse Recovery Loss
- Low Forward Voltage
- High Surge Current Capability
- Low Inductance Package



## APPLICATIONS

- Inversion Welder
- Uninterruptible Power Supply (UPS)
- Plating Power Supply
- Ultrasonic Cleaner and Welder
- Converter & Chopper
- Power Factor Correction (PFC) Circuit

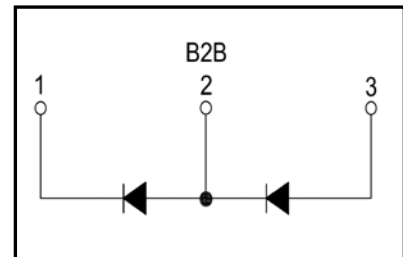

## ABSOLUTE MAXIMUM RATINGS

$T_C=25^{\circ}\text{C}$  unless otherwise specified

Symbol	Parameter	Test Conditions	Values	Unit
$V_R$	Maximum D.C. Reverse Voltage		1200	V
$V_{RRM}$	Maximum Repetitive Reverse Voltage		1200	V
$I_{F(AV)}$	Average Forward Current	$T_C=110^{\circ}\text{C}$ , Per Diode	200	A
		$T_C=120^{\circ}\text{C}$ , 20KHz, Per Diode	150	A
$I_{F(RMS)}$	RMS Forward Current	$T_C=110^{\circ}\text{C}$ , Per Diode	280	A
$I_{FSM}$	Non-Repetitive Surge Forward Current	$T_J=45^{\circ}\text{C}$ , $t=10\text{ms}$ , 50Hz, Sine	1800	A
		$T_J=45^{\circ}\text{C}$ , $t=8.3\text{ms}$ , 60Hz, Sine	1950	A
$I^2t$	$I^2t$ (For Fusing)	$T_J=45^{\circ}\text{C}$ , $t=10\text{ms}$ , 50Hz, Sine	16200	$\text{A}^2\text{s}$
		$T_J=45^{\circ}\text{C}$ , $t=8.3\text{ms}$ , 60Hz, Sine	19012	$\text{A}^2\text{s}$
$P_D$	Power Dissipation		568	W
$T_J$	Junction Temperature		-40 to +150	$^{\circ}\text{C}$
$T_{STG}$	Storage Temperature Range		-40 to +125	$^{\circ}\text{C}$
$V_{isol}$	Insulation Test Voltage	AC, $t=1\text{min}$	3000	V
Torque	Module-to-Sink	Recommended (M6)	3~5	N·m
Torque	Module Terminal	Recommended (M6)	3~5	N·m
$R_{\theta JC}$	Thermal Resistance	Junction-to-Case	0.22	$^{\circ}\text{C}/\text{W}$
Weight			160	g

ELECTRICAL CHARACTERISTICS

T<sub>C</sub>=25°C unless otherwise specified

Symbol	Parameter	Test Conditions	Min.	Typ.	Max.	Unit
I <sub>RM</sub>	Reverse Leakage Current	V <sub>R</sub> =1200V	--	--	2	mA
		V <sub>R</sub> =1200V, T <sub>J</sub> =125°C	--	--	10	mA
V <sub>F</sub>	Forward Voltage	I <sub>F</sub> =200A	--	2.3	--	V
		I <sub>F</sub> =200A, T <sub>J</sub> =125°C	--	1.9	--	V
t <sub>rr</sub>	Reverse Recovery Time	I <sub>F</sub> =1A, V <sub>R</sub> =30V, di <sub>F</sub> /dt=-200A/μs	--	57	--	ns
t <sub>rr</sub>	Reverse Recovery Time	V <sub>R</sub> =600V, I <sub>F</sub> =200A	--	110	--	ns
I <sub>RRM</sub>	Max. Reverse Recovery Current		di <sub>F</sub> /dt=-200A/μs, T <sub>J</sub> =25°C	--	9	--
t <sub>rr</sub>	Reverse Recovery Time	V <sub>R</sub> =600V, I <sub>F</sub> =200A	--	500	--	ns
I <sub>RRM</sub>	Max. Reverse Recovery Current		di <sub>F</sub> /dt=-200A/μs, T <sub>J</sub> =125°C	--	21	--

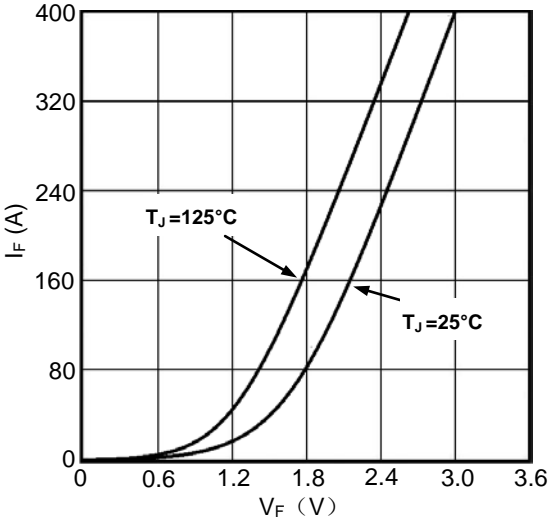

Figure1. Forward Voltage Drop vs Forward Current

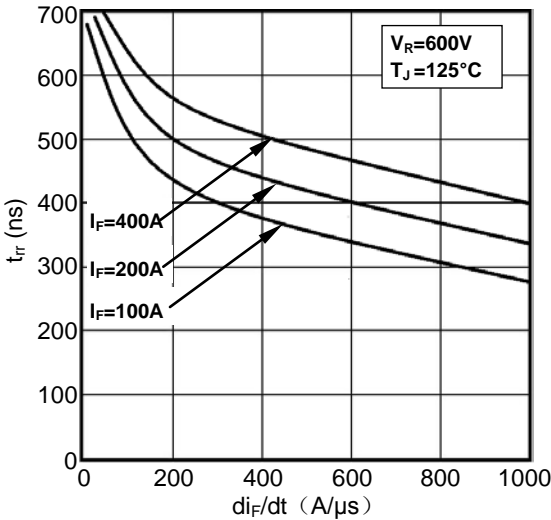

Figure2. Reverse Recovery Time vs di<sub>F</sub>/dt

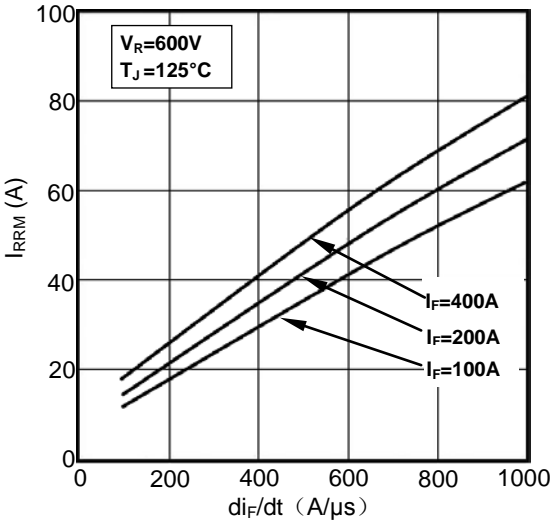

Figure3. Reverse Recovery Current vs di<sub>F</sub>/dt

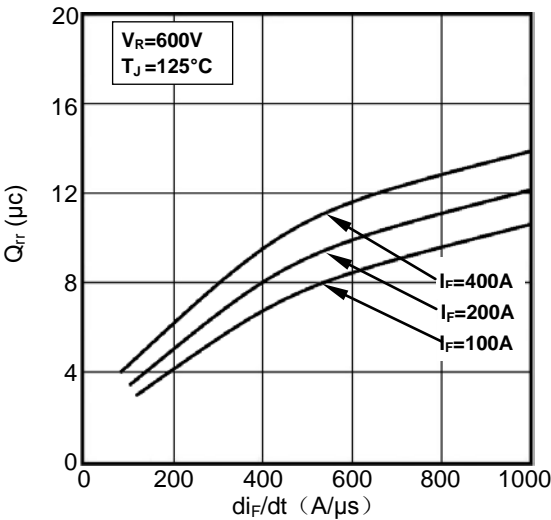

Figure4. Reverse Recovery Charge vs di<sub>F</sub>/dt

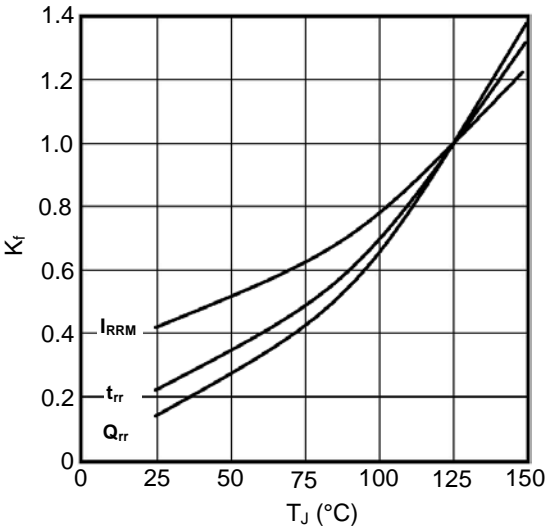

Figure5. Dynamic Parameters vs Junction Temperature

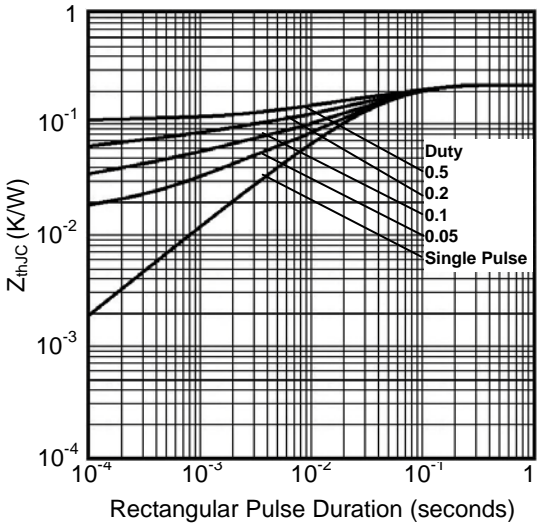
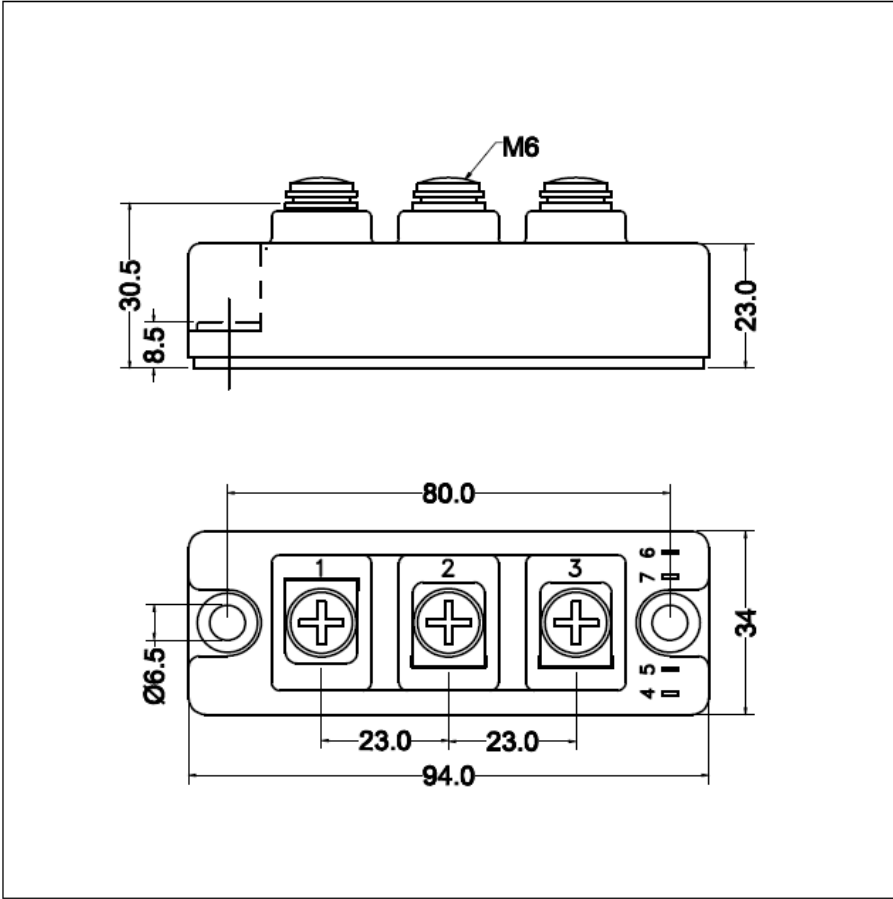

Figure6. Transient Thermal Impedance



Dimensions (mm)  
Figure7. Package Outline