

FEATURES

- Low Forward Voltage
- High Surge Current Capability
- Low Leakage Current
- Low Inductance Package

APPLICATIONS

- Field Supply For DC Motors
- Line Rectifiers For Transistorized AC Motor Controllers
- Non-controllable Rectifiers For AC/DC Converter

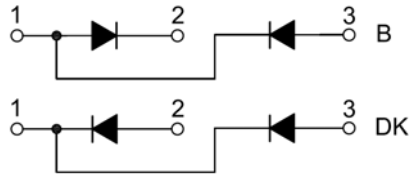

MODULE TYPE

TYPE	Circuit Diagram		VRRM (Repetitive Peak Reverse Voltage)	VRSM (Non-Repetitive Peak Reverse Voltage)	Unit
	B	DK			
MMD60A120B	MMD60A120DK	1200	1300	V	
MMD60A140B	MMD60A140DK	1400	1500		
MMD60A160B	MMD60A160DK	1600	1700		
MMD60A180B	MMD60A180DK	1800	1900		

ABSOLUTE MAXIMUM RATINGS

T_c=25°C unless otherwise specified

Symbol	Parameter	Test Conditions	Values	Unit
I _{F(AV)}	Average Forward Current	Single phase, half wave, 180°conduction, T _c = 90°C	60	A
I _{F(RMS)}	R.M.S. Forward Current		94	
I _{FSM}	Non-Repetitive Surge Forward Current	1/2 cycle, 50HZ, peak value T _c =45°C	1350	
		1/2 cycle, 60HZ, peak value T _c =45°C	1450	
I ² t	I ² t (For Fusing)	1/2 cycle, 50HZ, peak value T _c =45°C	9.1	KA ² s
		1/2 cycle, 60HZ, peak value T _c =45°C	8.7	KA ² s
P _D	Power Dissipation		195	W
T _J	Junction Temperature		-40 to +150	°C
T _{STG}	Storage Temperature Range		-40 to +125	°C
V _{ISO}	Isolation Breakdown Voltage	AC, 50Hz(R.M.S), t=1minute	3000	V
Torque	Module-to-Sink	Recommended (M6)	3~5	N.m
Torque	Module Electrodes	Recommended (M5)	2.5~5	N.m
R _{th (J-C)}	Junction-to-Case Thermal Resistance		0.63	K /W
Weight			110	g

MMD60A

ELECTRICAL AND THERMAL CHARACTERISTICS $T_C=25^\circ\text{C}$ unless otherwise specified

Symbol	Parameter	Test Conditions	Min.	Typ.	Max.	Unit
I_{RM}	Max.Reverse Leakage Current	$V_R = V_{RRM}$			500	μA
		$V_R = V_{RRM}, T_J = 125^\circ\text{C}$			10	mA
V_F	Forward Voltage	$I_F = 180\text{A}$			1.5	V
V_{T0}	For power-loss calculations only				0.85	V
r_T	$T_J = 125^\circ\text{C}$				3.6	m Ω

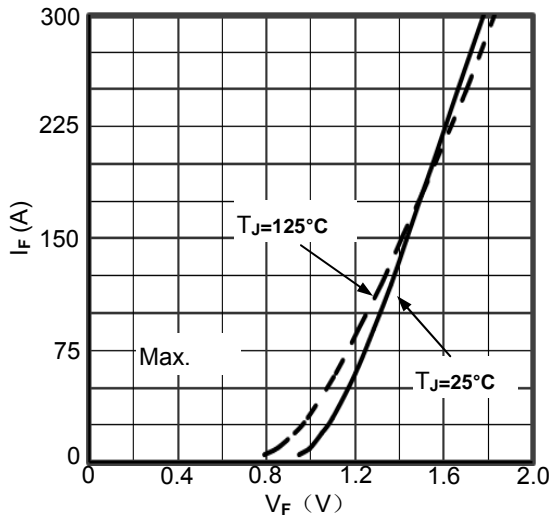

Figure 1. Forward current vs. voltage drop

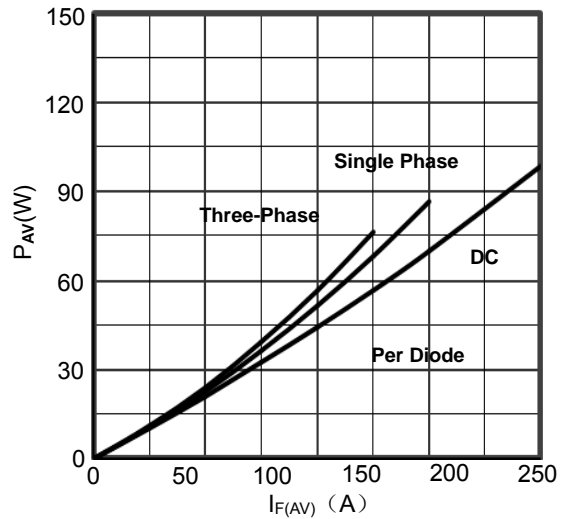

Figure 2. Diode Power dissipation vs. $I_{F(AV)}$

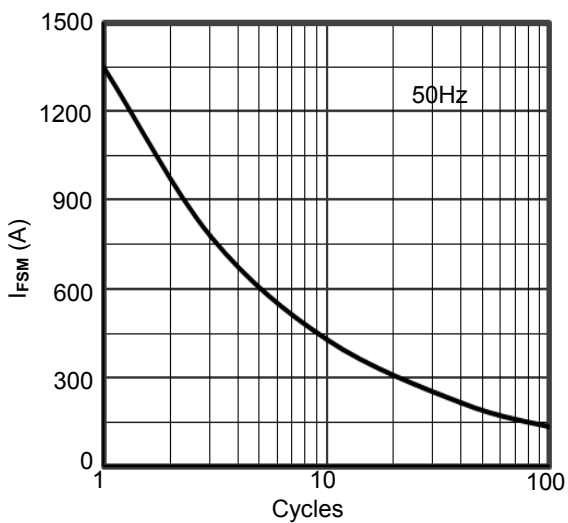

Figure 3. Max Non-Repetitive Forward Surge Current

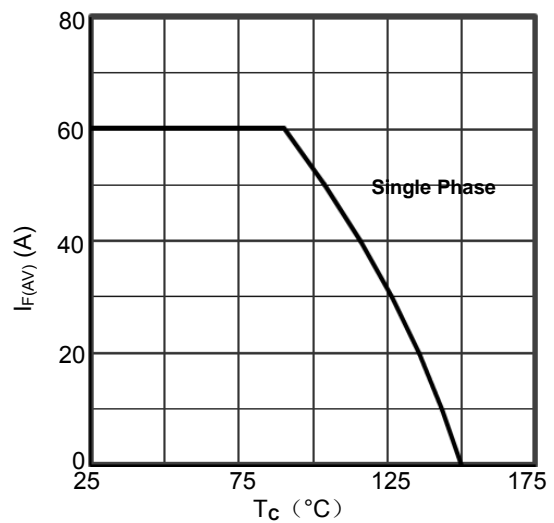

Figure 4. Forward current vs. Case temperature

MMD60A

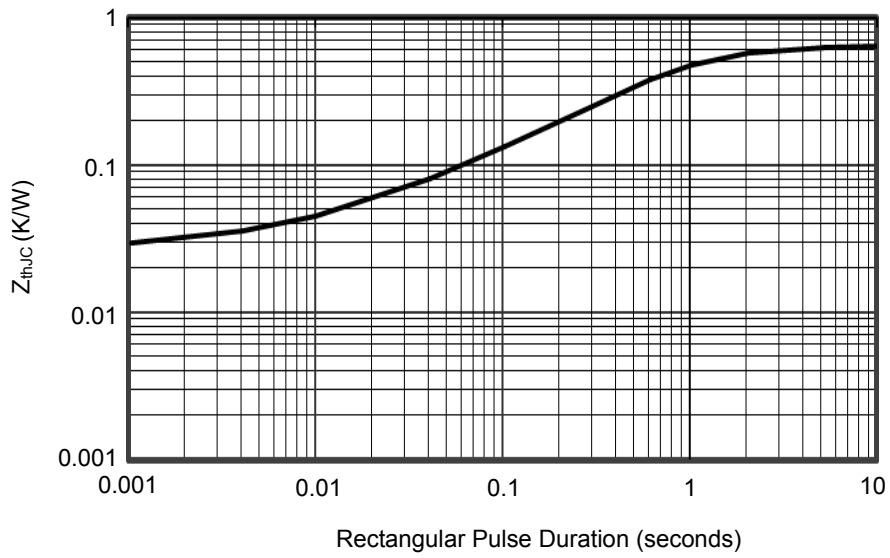
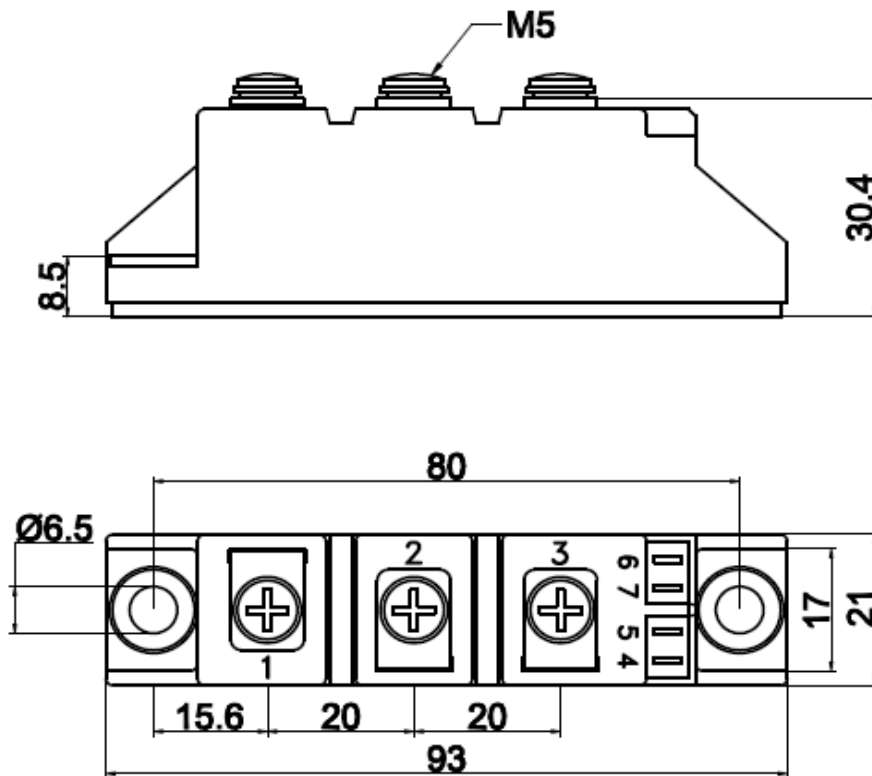

Figure5. Transient Thermal Impedance



Dimensions in Millimeters and (Inchs)
Figure6. Package Outline