

PRODUCT FEATURES

- Low Forward Voltage
- High Surge Current Capability
- Low Leakage Current
- Low Inductance Package

APPLICATIONS

- Field Supply For DC Motors
- Line Rectifiers For Transistorized AC Motor Controllers
- Non-controllable Rectifiers For AC/DC Converter

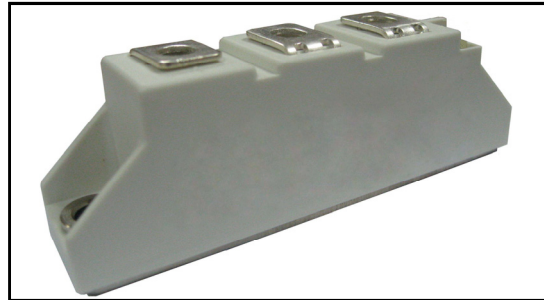
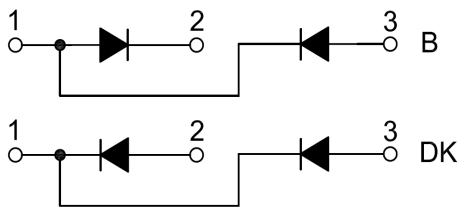

Module Type

Module Type	Circuit Diagram		V_{RRM} (Repetitive Peak Reverse Voltage)	V_{RSM} (Non-Repetitive Peak Reverse Voltage)	Unit
	B	DK			
MMD130A120B	MMD130A120DK	1200	1300	V	
MMD130A140B	MMD130A140DK	1400	1500		
MMD130A160B	MMD130A160DK	1600	1700		
MMD130A180B	MMD130A180DK	1800	1900		

ABSOLUTE MAXIMUM RATINGS

$T_C = 25^\circ\text{C}$ unless otherwise specified

Symbol	Parameter/Test Conditions		Values	Unit
$I_{F(AV)}$	Average Forward Current	Single phase, half wave, 180° conduction, $T_c = 95^\circ\text{C}$	130	A
$I_{F(RMS)}$	R.M.S. Forward Current	Single phase, half wave, 180° conduction, $T_c = 95^\circ\text{C}$	204	
I_{FSM}	Non-Repetitive Surge Forward Current	1/2 cycle, 50HZ, peak value $T_c = 45^\circ\text{C}$	3450	
		1/2 cycle, 60HZ, peak value, $T_c = 45^\circ\text{C}$	3750	
I^2t	For Fusing	1/2 cycle, 50HZ, peak value $T_c = 45^\circ\text{C}$	59.5	KA ² S
		1/2 cycle, 60HZ, peak value, $T_c = 45^\circ\text{C}$	58.3	
P_D	Power Dissipation		500	W
T_J	Junction Temperature		-40 to +150	°C
T_{STG}	Storage Temperature Range		-40 to +125	°C
V_{ISO}	Isolation Breakdown Voltage	AC, 50Hz(R.M.S), $t=1$ minute	3000	V
Torque	Module-to-Sink	Recommended (M6)	3~5	N.m
	Module Electrodes	Recommended (M5)	2.5~5	N.m
$R_{th(J-C)}$	Junction-to-Case Thermal Resistance		0.25	K/W
Weight			110	g

ELECTRICAL CHARACTERISTICS

$T_C = 25^\circ\text{C}$ unless otherwise specified

Symbol	Parameter/Test Conditions	Min.	Typ.	Max.	Unit
I_{RM}	Maximum Reverse Leakage Current			0.5	mA
				$V_R = V_{RRM}, T_J = 125^\circ\text{C}$	
V_F	Forward Voltage Drop			1.5	V
V_{TO}	For power-loss calculations only, $T_J = 125^\circ\text{C}$			0.85	V
r_T				1.6	m Ω

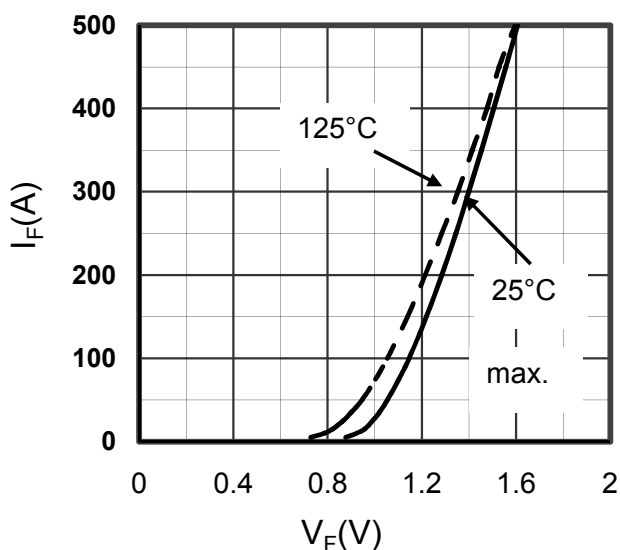

Figure1. Forward Voltage Drop vs Forward Current

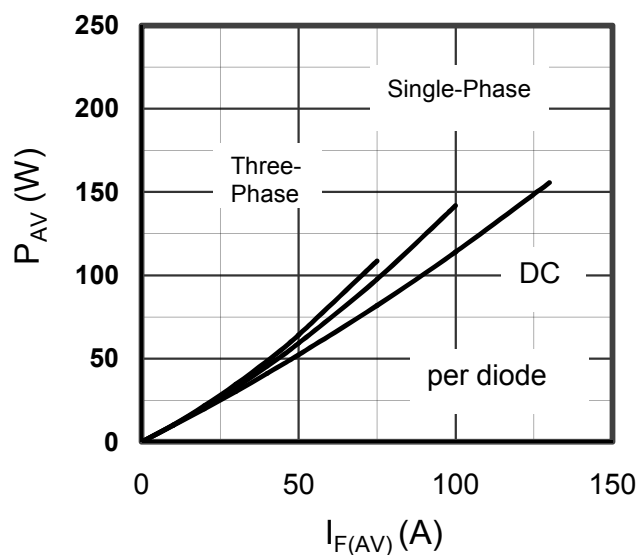

Figure2. Power dissipation vs. $I_{F(AV)}$

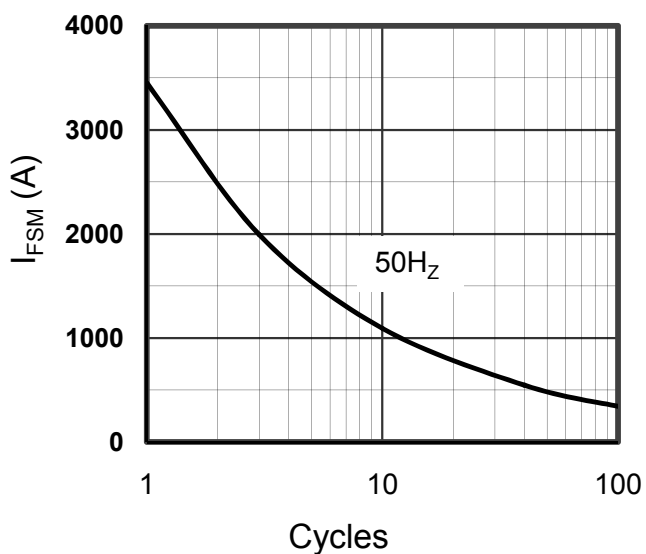

Figure3. Max Non-Repetitive Forward Surge Current

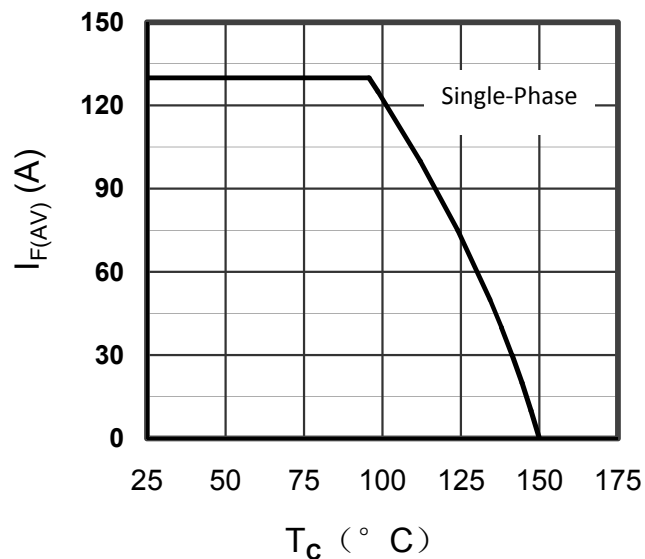
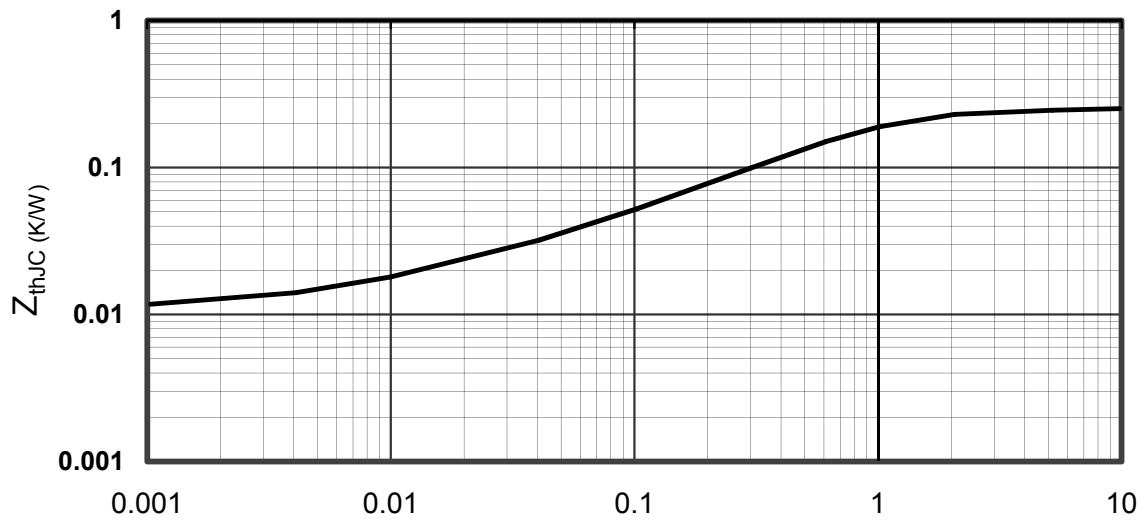
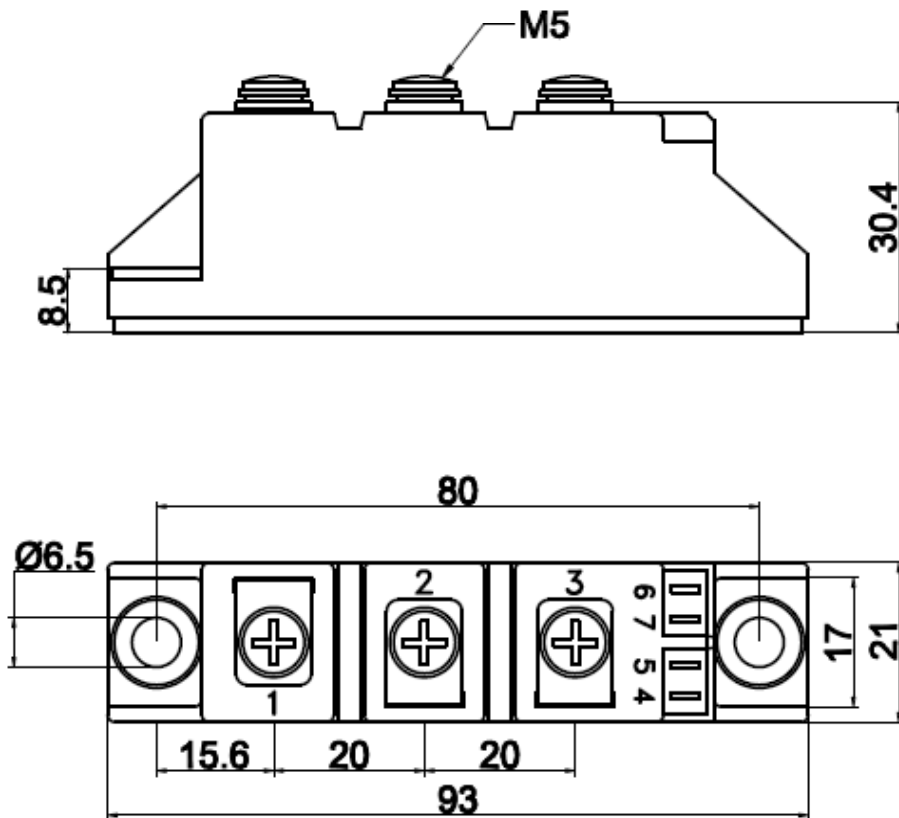

Figure4. Forward current vs. Case temperature



Rectangular Pulse Duration (seconds)

Figure5. Transient Thermal Impedance



Dimensions in Millimeters and (Inchs)

Figure6. Package Outline