

PRODUCT FEATURES

- Proprietary New Trench Technology
- $R_{DS(ON),typ}=4.5m\Omega@V_{GS}=10V$
- Low Gate Charge Minimize Switching Loss
- Fast Recovery body Diode

APPLICATIONS

- High efficiency DC/DC Converters
- Synchronous Rectification
- UPS inverter

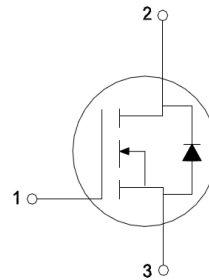

1.GATE
2.DRAIN
3.SOURCE

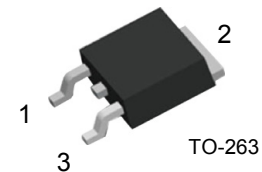
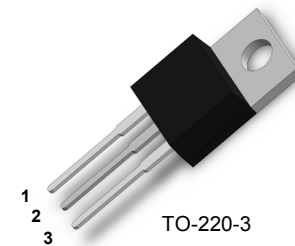

Type	V _{DS}	I _D	R _{DS(ON)} .max T _J =25°C	T _{Jmax}	Marking	Package
MM4310K	100V	151	6.0mΩ	175°C	MM4310K	TO-220
MM4310S	100V	151	6.0mΩ	175°C	MM4310S	TO-263

ABSOLUTE MAXIMUM RATINGS

T_C = 25°C unless otherwise specified

Symbol	Parameter/Test Conditions	Values	Unit
V _{DSS}	Drain Source Voltage	T _J =25°C	100
V _{GSS}	Gate Source Voltage		±20
I _D	Continuous Drain Current	T _C =25°C(Silicon limited)	151 ^①
		T _C =100°C(Silicon limited)	106 ^①
I _{DM}	Pulsed Drain Current at V _{GS} =10V	Limited by T _{Jmax}	679
P _D	Maximum Power Dissipation		312
E _{AS}	Single Pulse Avalanche Energy (V _{DD} =50V, L=1mH)		980
T _{Jmax}	Max. Junction Temperature		175
T _{STG}	Storage Temperature Range		-55~175
Torque	Module to Sink (TO-220)	Recommended (M3)	1.1
Weight			2.5

① Calculated continuous current based on maximum allowable junction temperature. Package limitation current is 80A.

THERMAL CHARACTERISTICS

T_C = 25°C unless otherwise specified

Symbol	Parameter/Test Conditions	Values	Unit
R _{thJC}	Thermal resistance, junction to case	0.48	°C/W
R _{thJA}	Thermal resistance, junction to ambient	62	

ELECTRICAL CHARACTERISTICS

 $T_C = 25^\circ\text{C}$ unless otherwise specified

Symbol	Parameter/Test Conditions		Min.	Typ.	Max.	Unit
$V_{(BR)DSS}$	Drain Source Breakdown Voltage	$V_{GS}=0V, I_D=250\mu A$	100			V
$R_{DS(ON)}$	Drain Source ON Resistance	$V_{GS}=10V, I_D=75A$		4.5	6	m Ω
I_{DSS}	Drain Source Leakage Current	$V_{DS}=100V, V_{GS}=0V$			25	μA
$V_{GS(th)}$	Gate Threshold Voltage	$V_{GS} = V_{DS}, I_D=250\mu A$	2.0		4.0	V
I_{GSS}	Gate Leakage Current	$V_{DS}=0V, V_{GS}=\pm 20V$	-100		100	nA
R_{gint}	Integrated Gate Resistor			2.4		Ω
Q_g	Total Gate Charge	$V_{DD}=65V, I_D=75A, V_{GS}=10V$		165		nC
Q_{gs}	Gate Source Charge			42		nC
Q_{gd}	Gate Drain Charge			55		nC
g_{fs}	Forward Transconductance	$V_{DS}=10V, I_D=75A$		TBD		S
C_{iss}	Input Capacitance	$V_{DS}=25V, V_{GS}=0V, f=1\text{MHz}$		11		nF
C_{oss}	Output Capacitance			760		pF
C_{rss}	Reverse Transfer Capacitance			180		pF
$t_{d(on)}$	Turn on Delay Time	$V_{DD}=65V, I_D=75A,$ $R_G = 2.2\Omega,$ $V_{GS}=10V$	$T_J=25^\circ\text{C}$		55	ns
t_r	Rise Time				165	ns
$t_{d(off)}$	Turn off Delay Time				160	ns
t_f	Fall Time				130	ns

Source-Drain BODY-DIODE CHARACTERISTICS

 $T_C = 25^\circ\text{C}$ unless otherwise specified

Symbol	Parameter/Test Conditions		Min.	Typ.	Max.	Unit
I_{SD}	Continuous Source Drain Current				151	A
I_{SDM}	Pulse Source Drain Current	Limited by T_{Jmax}			679	A
V_{SD}	Forward Voltage	$I_S=75A, V_{GS}=0V$			1.2	V
t_{rr}	Reverse Recovery time	$I_F=75A, V_{GS}=0V$		80		ns
Q_{RR}	Reverse Recovery Charge	$di_F/dt=-100A/\mu s$		200		nC

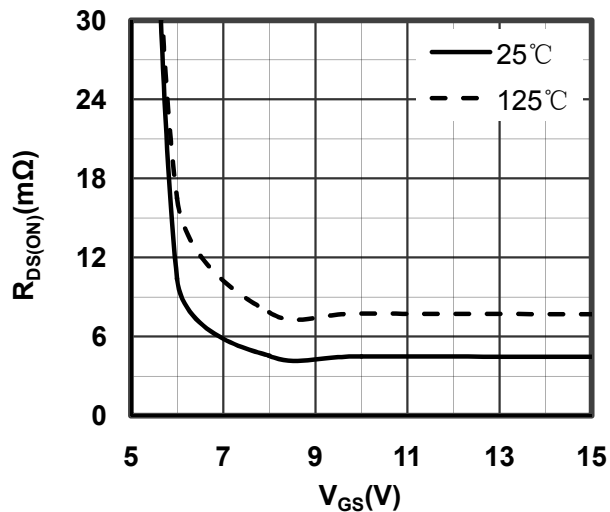

Figure 1. Typical $R_{DS(ON)}$ vs Gate Voltage

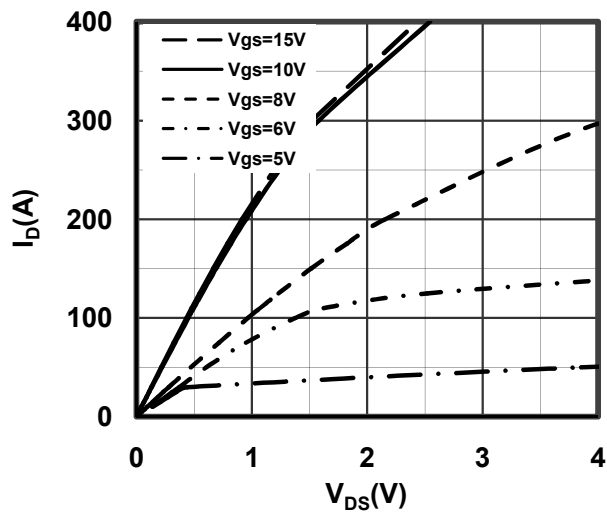

Figure 2. Typical Output Characteristics

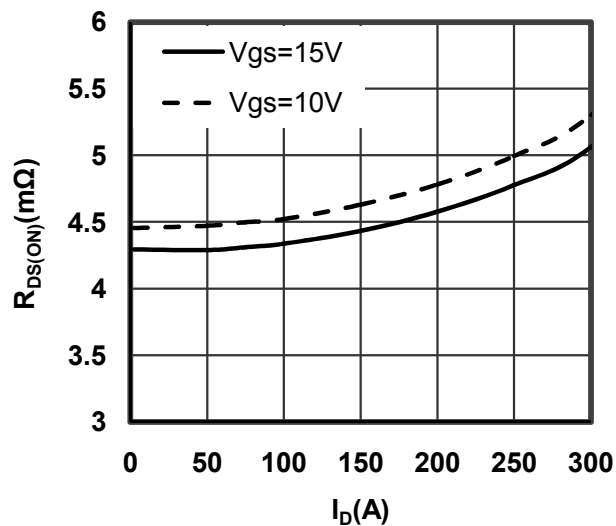

Figure 3. Drain-Source ON Resistance vs I_D

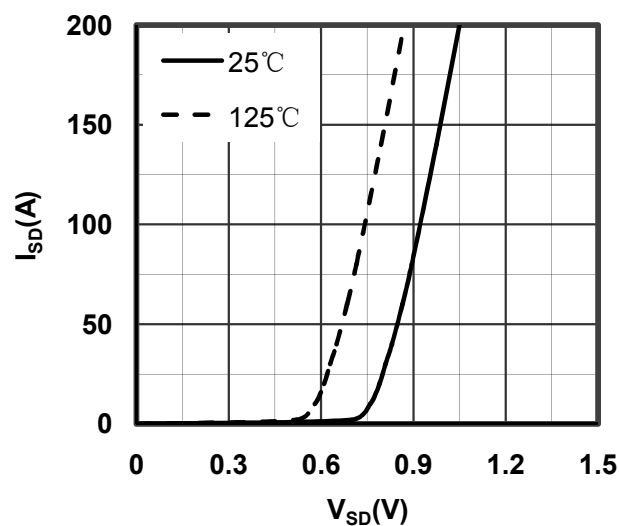

Figure 4. Source-Drain Voltage

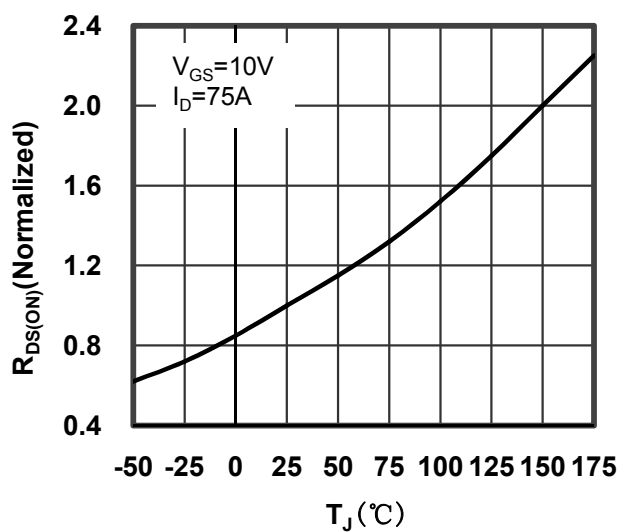

Figure 5. Drain-Source ON Resistance vs Junction Temperature

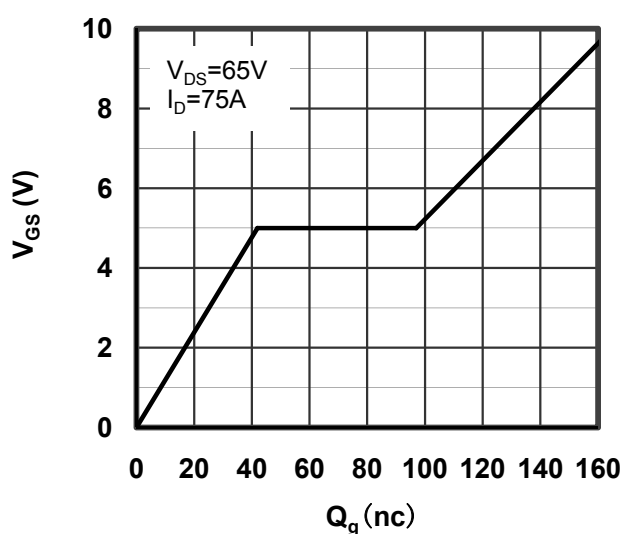

Figure 6. Gate Charge characteristics

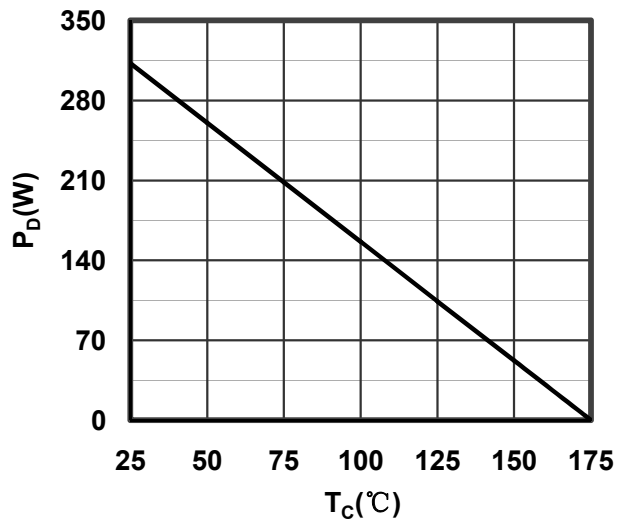

Figure 7. Maximum Power Dissipation vs Case Temperature

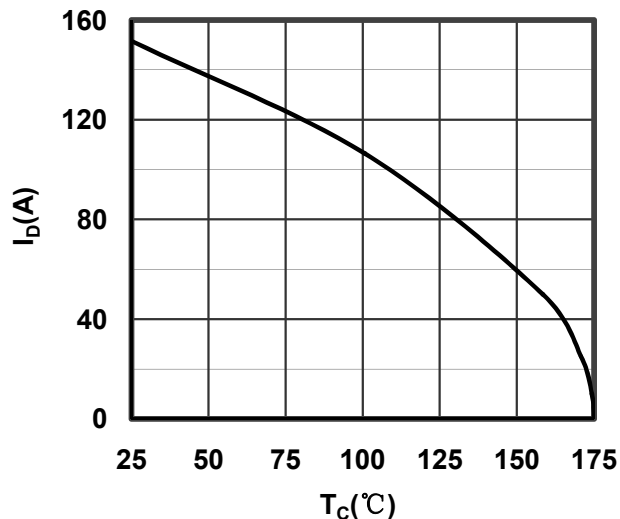

Figure 8. Maximum Continuous Drain Current vs Case Temperature

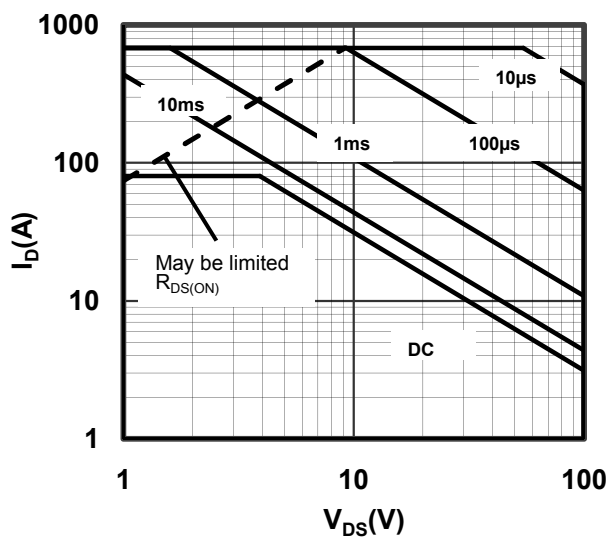

Figure 9. Maximum Forward Safe Operation Area

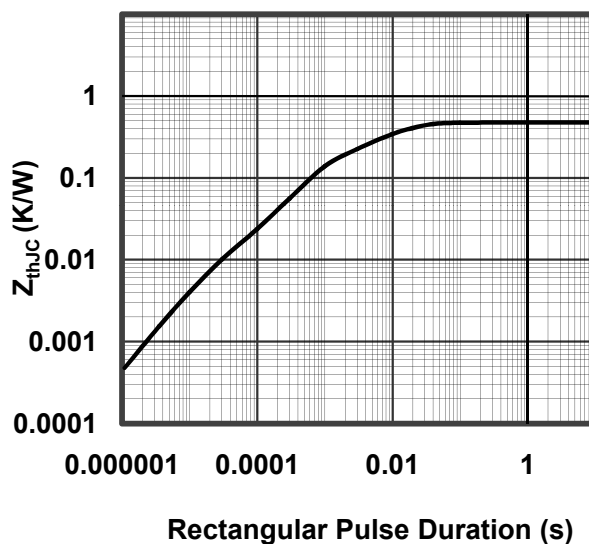
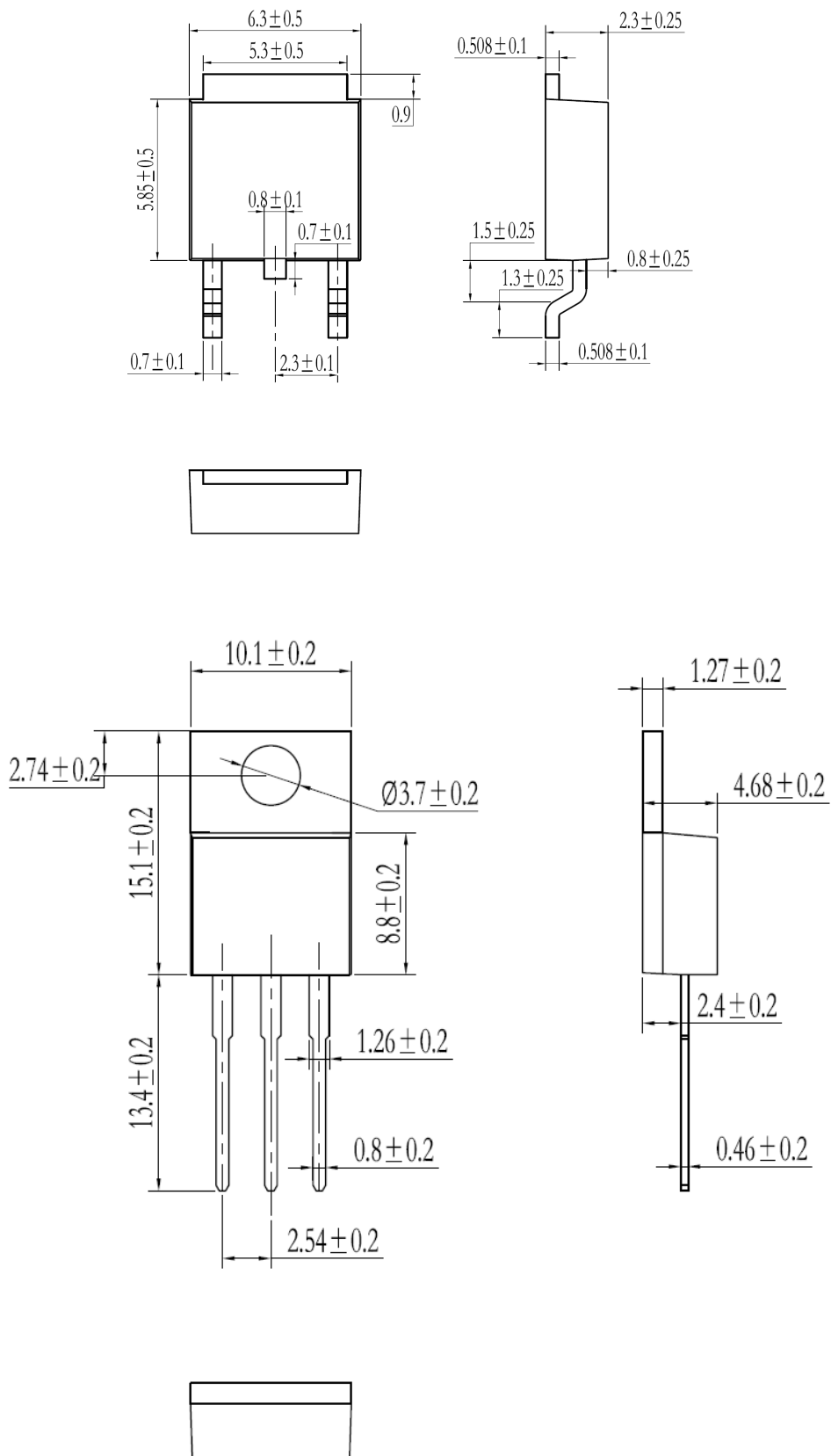

Figure 10. Transient Thermal Impedance



Dimensions in (mm)
Figure 11. Package Outline