

PRODUCT FEATURES

- Ultrafast Recovery Time
- Soft Recovery Characteristics
- Low Recovery Loss
- Low Forward Voltage
- High Surge Current Capability
- Low Leakage Current

APPLICATIONS

- Freewheeling, Snubber, Clamp
- Inversion Welder
- PFC
- Plating Power Supply
- Ultrasonic Cleaner and Welder
- Converter & Chopper
- UPS

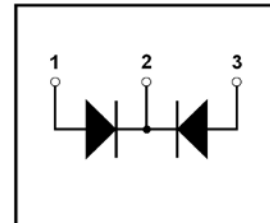
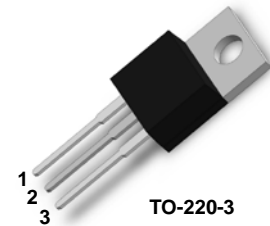

DESCRIPTION

FRED from MacMic utilizes advanced processing techniques to achieve ultrafast recovery times and higher forward current. Its soft recovery characteristics and high reliability suit for wide industrial applications.

ABSOLUTE MAXIMUM RATINGS

$T_C=25^\circ\text{C}$ unless otherwise specified

Symbol	Parameter	Test Conditions	Values	Unit
V_R	Maximum D.C. Reverse Voltage		200	V
V_{RRM}	Maximum Repetitive Reverse Voltage		200	V
$I_{F(AV)}$	Average Forward Current	$T_C=110^\circ\text{C}$, Per Diode	8	A
		$T_C=110^\circ\text{C}$, Per Package	16	A
$I_{F(RMS)}$	RMS Forward Current	$T_C=110^\circ\text{C}$, Per Diode	12	A
I_{FSM}	Non-Repetitive Surge Forward Current	$T_J=45^\circ\text{C}$, $t=10\text{ms}$, 50Hz, Sine	100	A
P_D	Power Dissipation		50	W
T_J	Junction Temperature		-40 to +150	$^\circ\text{C}$
T_{STG}	Storage Temperature Range		-40 to +150	$^\circ\text{C}$
Torque	Module-to-Sink	Recommended (M3)	1.1	N-m
$R_{\theta JC}$	Thermal Resistance	Junction-to-Case	2.5	$^\circ\text{C/W}$
Weight			2.1	g

ELECTRICAL CHARACTERISTICS

$T_C=25^\circ\text{C}$ unless otherwise specified

Symbol	Parameter	Test Conditions	Min.	Typ.	Max.	Unit
I_{RM}	Reverse Leakage Current	$V_R=200\text{V}$	--	--	15	μA
		$V_R=200\text{V}$, $T_J=125^\circ\text{C}$	--	--	250	μA
V_F	Forward Voltage	$I_F=8\text{A}$	--	0.87	1.0	V
		$I_F=8\text{A}$, $T_J=125^\circ\text{C}$	--	0.78	--	V
t_{rr}	Reverse Recovery Time	$I_F=1\text{A}$, $V_R=30\text{V}$, $di_F/dt=-200\text{A}/\mu\text{s}$	--	20	--	ns
t_{rr}	Reverse Recovery Time	$V_R=100\text{V}$, $I_F=8\text{A}$	--	25	--	ns
I_{RRM}	Max. Reverse Recovery Current	$di_F/dt=-200\text{A}/\mu\text{s}$, $T_J=25^\circ\text{C}$	--	3.0	--	A
t_{rr}	Reverse Recovery Time	$V_R=100\text{V}$, $I_F=8\text{A}$	--	40	--	ns
I_{RRM}	Max. Reverse Recovery Current	$di_F/dt=-200\text{A}/\mu\text{s}$, $T_J=125^\circ\text{C}$	--	5.5	--	A

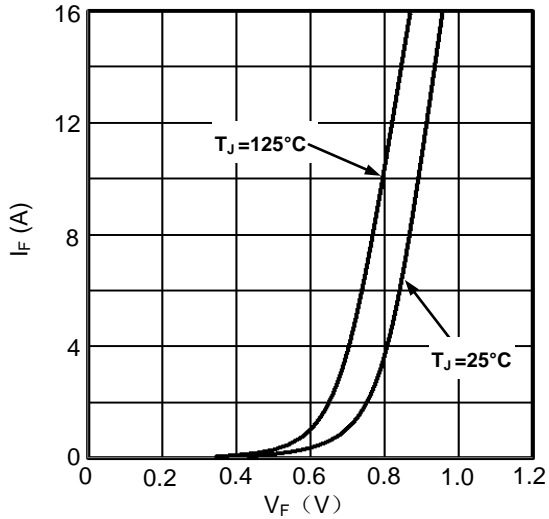

Fig1. Forward Voltage Drop vs Forward Current

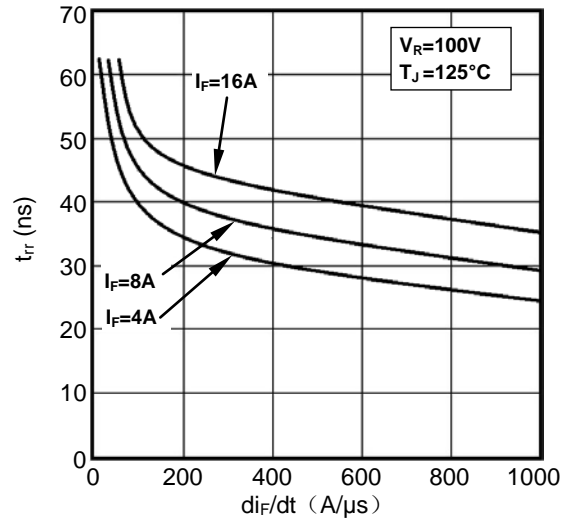

Fig2. Reverse Recovery Time vs di_F/dt

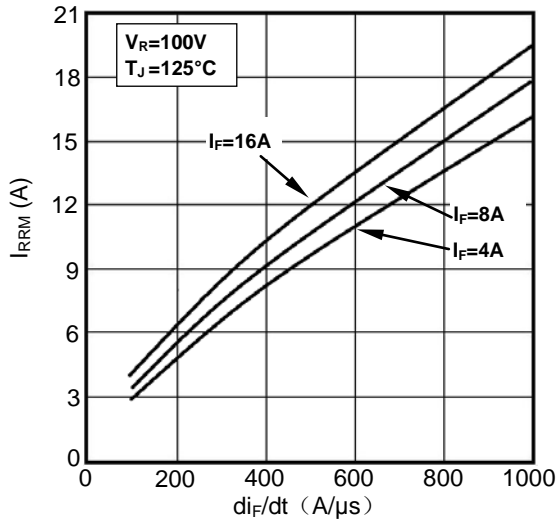

Fig3. Reverse Recovery Current vs di_F/dt

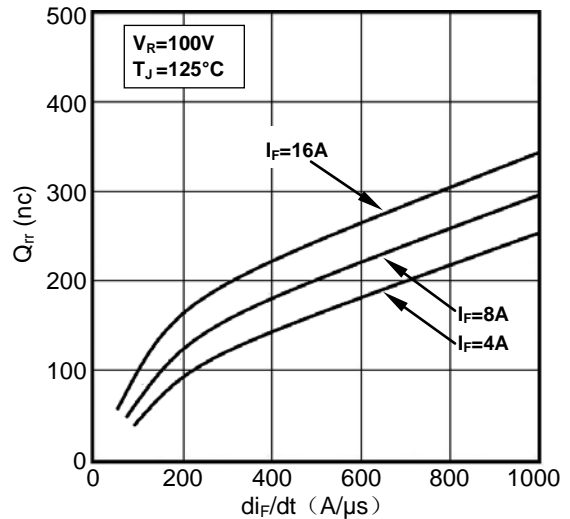

Fig4. Reverse Recovery Charge vs di_F/dt

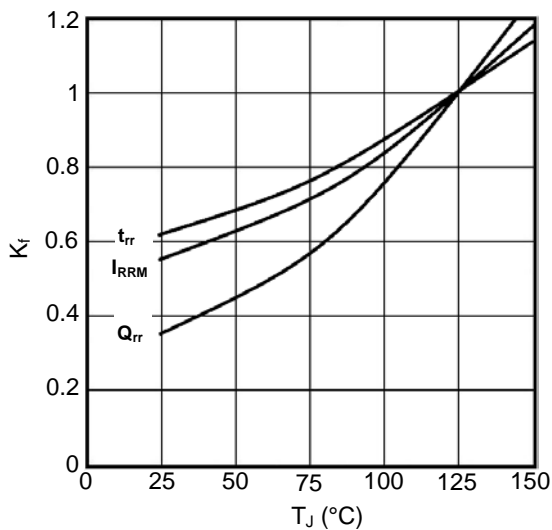

Fig5. Dynamic Parameters vs Junction Temperature

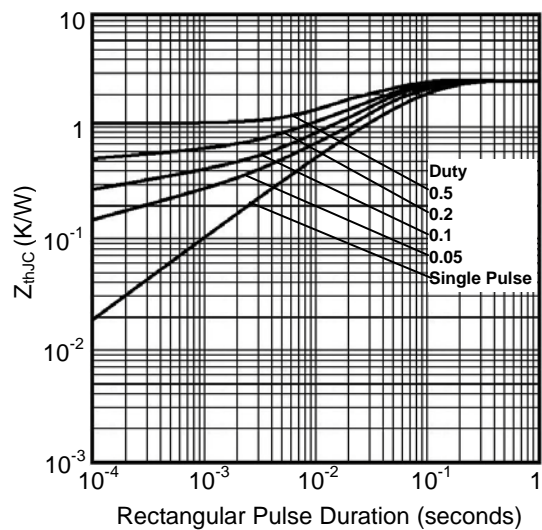

Fig6. Transient Thermal Impedance

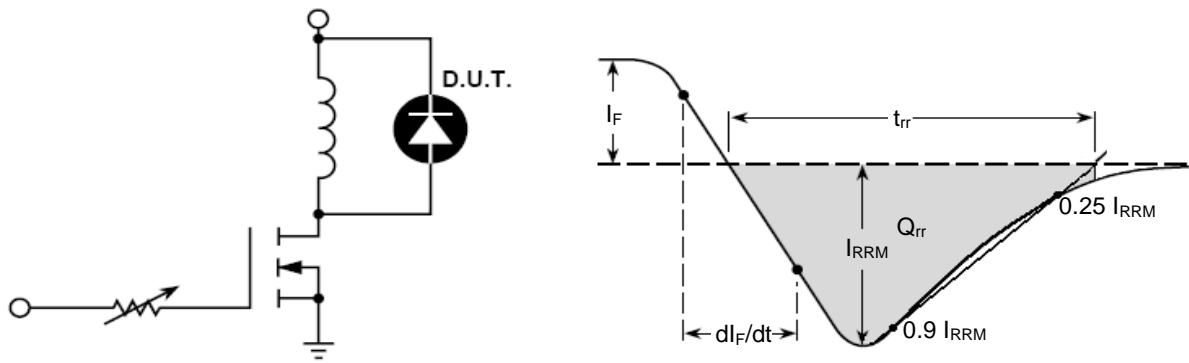
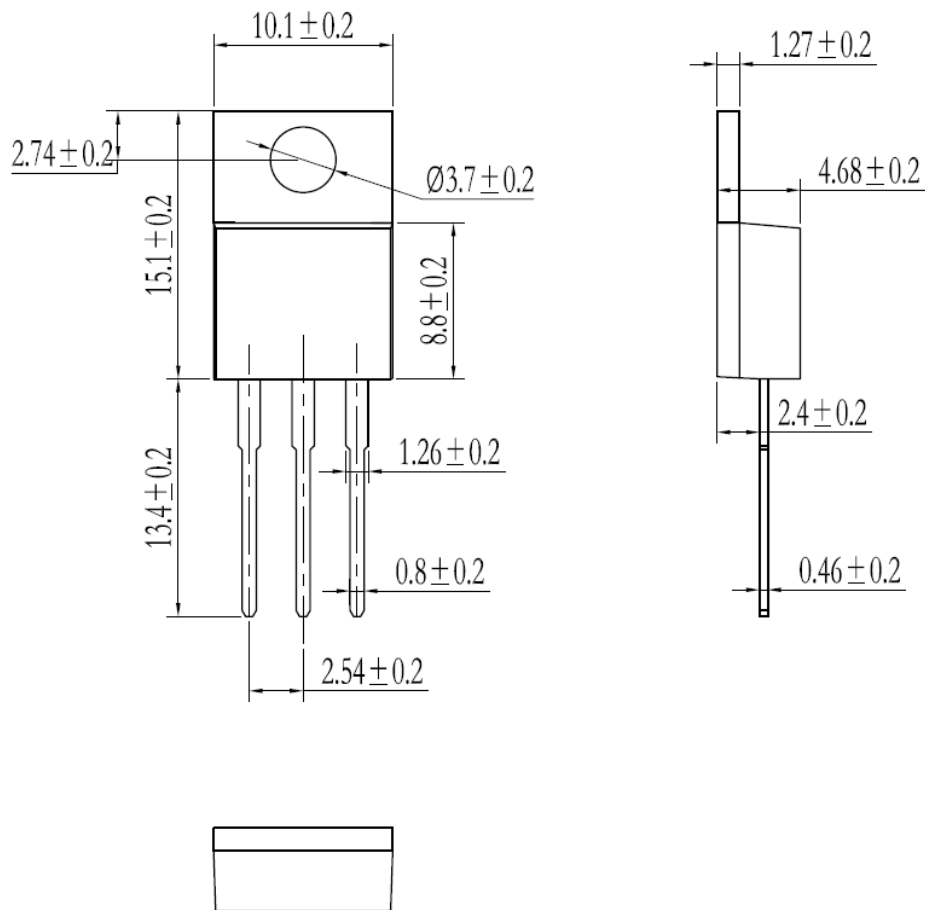

Fig7. Diode Reverse Recovery Test Circuit and Waveform



Dimensions in Millimeters
Fig8. Package Outline